

## Taps & Dies

### HSS Spiral Point Taps

Type 20-AG Fractional / Machine Screw . . .	55
Type 20-AGN Fractional / Machine Screw . . .	55
Type 20 Fractional / Machine Screw . . . . .	55
Type 21-AG Metric . . . . .	55
Type 21-AGN Metric - TiN Coated . . . . .	55
Type 21 Metric . . . . .	55

### HSS Straight Flute Taps

Type 23-AG Taper . . . . .	58 - 60
Type 23-AGN Taper - TiN Coated . . . . .	58 - 60
Type 23 Taper . . . . .	58 - 60
Type 24-AG Plug . . . . .	58 - 60
Type 24-AGN Plug - TiN Coated . . . . .	58 - 60
Type 24 Plug . . . . .	58 - 60
Type 25-AG Bottoming . . . . .	58 - 60
Type 25-AGN Bottoming - TiN Coated . . . . .	58 - 60
Type 25 Bottoming . . . . .	58 - 60
Type 26-AG Sets . . . . .	61
Type 26-AGN Sets TiN Coated . . . . .	61
Type 26 Sets . . . . .	61

### HSS Straight Flute -Metric

Type 31-AG Taper . . . . .	62
Type 31-AGN Taper - TiN Coated . . . . .	62
Type 31 Taper - Metric . . . . .	62
Type 32-AG Plug . . . . .	62
Type 32-AGN Plug - TiN Coated . . . . .	62
Type 32 Plug - Metric . . . . .	62
Type 33-AG Bottoming . . . . .	62
Type 33-AGN Bottoming - TiN Coated . . . . .	62

Type 33 Bottoming - Metric . . . . .	62
Type 35-AG Sets . . . . .	63
Type 35-AGN Sets - TiN Coated . . . . .	63

### HSS Straight Flute -Left-Hand Thread

Type 23L-AG Taper . . . . .	64
Type 24L-AG Plug . . . . .	64
Type 25L-AG Bottoming . . . . .	64

### **NEW** HSS Combination Drill & Tap

Type 40-AG . . . . .	65
Type 40-QR . . . . .	65

### Drill & Tap Combo

Type 34-AG . . . . .	65
----------------------	----

### HSS Hex Dies

Type 27-AG . . . . .	66
Type 27-AG Metric . . . . .	66

### High Performance Spiral Tap

Type 29-AG . . . . .	56
Type 29-AGN . . . . .	56
Type 29-ACN . . . . .	57
Type 29-ALN . . . . .	57

### **NEW** M42 Cobalt Taps & TiN Coated

Type 24-RNC . . . . .	58
Type 24-RNCN Cobalt . . . . .	58

### Taper Pipe Taps

Type 30-AG . . . . .	63
Type 30-AGN - TiN Coated . . . . .	63
Type 30-B Black Oxide . . . . .	63
Type 30 Bright . . . . .	63

### Interrupted Taper Pipe Taps

Type I30-AG Interrupted . . . . .	63
Type I30-AGN TiN Coated - Interrupted . . . . .	63
Type I30-B Black Oxide - Interrupted . . . . .	63
Type I30 Bright - Interrupted . . . . .	63

### HSS Tap & Drill Sets

SF-18TDC Straight Flute . . . . .	65
SF-18TDF Spiral Flute . . . . .	65
SP-10TD Straight Point . . . . .	65
SP-12TD Spiral Point . . . . .	65
SP-18TD Spiral Point . . . . .	65

SP-18TDM Spiral Point . . . . .	65
B-18TD HSS Drill & Tap Set . . . . .	65

### HSS Tap Sets

SP-19T Spiral Point . . . . .	66
SP-10T Spiral Point . . . . .	66
SF-10T Straight Flute . . . . .	66

### Drill, Tap & Countersink Set

TDC-12 . . . . .	66
------------------	----

### HSS Tap & Die Assortments

Magnum Super Premium	
14pc, 15pc Metric . . . . .	67
23pc, 25pc Metric . . . . .	67
40pc . . . . .	68
58pc . . . . .	68

### Hi-Carbon Steel Taps

Type 720 Plug - Fractional . . . . .	69
Type 721 Plug - Machine Screw . . . . .	69
Type 740 Taper - Fractional . . . . .	69
Type 741 Plug - Machine Screw . . . . .	69
Type 760 Bottoming - Fractional . . . . .	70
Type 761 Bottoming - Machine Screw . . . . .	70
Type 722 3 pcs. Set - Fractional . . . . .	70
Type 723 3 pcs. Set - Machine Screw . . . . .	70
Type 780 Plug Taps Metric . . . . .	73

### Hi-Carbon Steel Pipe Taps

Type 410 Fractional . . . . .	73
-------------------------------	----

### Hi-Carbon Steel Dies

Type 400 - Round . . . . .	72
Type 405 - Hex . . . . .	71
Type 415 - Adjustable . . . . .	72
Type 790 - Hex Metric . . . . .	71

### Hi-Carbon Tap & Die Sets

Type 724	
14pc, 16pc . . . . .	74
24pc, 37pc . . . . .	75
40pc . . . . .	76

### Tap & Reamer

#### Wrenches / Die Stocks

Type 725 . . . . .	77
Type 726 . . . . .	77
Type 727 . . . . .	77
Type 727R Ratcheting T-Handle . . . . .	77
Type 728 . . . . .	78
Type 729 . . . . .	78
Type 730 . . . . .	78

### Technical Reference . . . 79 - 83

QUICK INDEX - HSS / Hi-Carbon Taps & Dies



**HSS SPIRAL POINT PLUG TAPS**

**Gun Tap - Machine Screw / Fractional & METRIC - Ground Thread - Magnum Super Premium**

**Types 20-AG Gold Oxide, Type 20-AGN TiN Coated & Type 20 Bright**

**METRIC Types 21-AG Gold Oxide, Type 21-AGN TiN Coated & Type 21 Bright**

- Spiral point taps are designed for machine tapping through holes in a wide variety of materials. The point of the tap continuously ejects the chips ahead of the tap, eliminating chip disposal problems and thread damage.



**Type 20-AG**

Gold Oxide - low temperature stress relief that enhances lubricity, reduces friction and increases tap toughness.



**Type 20-AGN Titanium Nitride**

Titanium Nitride - increases wear resistance by producing a higher surface hardness and exceptional lubricity resulting in longer tool life.



**Type 20 Bright Finish**  
Bright Finish

Red Bold = most common used Taps

20-AG Part #	20-AGN Part #	20 Part #	Size	# of Flutes	H Limit	Qty. per/pack
67502	10502	60101	0-80	2	H1	3
<b>60100</b>	<b>10512</b>	<b>67501</b>	<b>0-80</b>	<b>2</b>	<b>H2</b>	<b>3</b>
67512	10522	60111	1-64	2	H1	3
<b>60110</b>	<b>10532</b>	<b>67511</b>	<b>1-64</b>	<b>2</b>	<b>H2</b>	<b>3</b>
67522	10542	67521	1-72	2	H1	3
<b>60120</b>	<b>10552</b>	<b>60121</b>	<b>1-72</b>	<b>2</b>	<b>H2</b>	<b>3</b>
<b>60130</b>	<b>10562</b>	<b>60131</b>	<b>2-56</b>	<b>2</b>	<b>H2</b>	<b>3</b>
<b>60140</b>	<b>10572</b>	<b>60141</b>	<b>2-64</b>	<b>2</b>	<b>H2</b>	<b>3</b>
<b>60150</b>	<b>10582</b>	<b>60151</b>	<b>3-48</b>	<b>2</b>	<b>H2</b>	<b>3</b>
67532	10592	67531	3-56	2	H1	3
<b>60160</b>	<b>10602</b>	<b>60161</b>	<b>3-56</b>	<b>2</b>	<b>H2</b>	<b>3</b>
67542	10612	67541	4-40	2	H1	3
<b>60170</b>	<b>10622</b>	<b>60171</b>	<b>4-40</b>	<b>2</b>	<b>H2</b>	<b>3</b>
67552	10632	67551	4-48	2	H1	3
<b>60180</b>	<b>10642</b>	<b>60181</b>	<b>4-48</b>	<b>2</b>	<b>H2</b>	<b>3</b>
<b>60190</b>	<b>10652</b>	<b>60191</b>	<b>4-36</b>	<b>2</b>	<b>H2</b>	<b>3</b>
67562	10662	67561	5-40	2	H1	3
<b>60200</b>	<b>10672</b>	<b>60201</b>	<b>5-40</b>	<b>2</b>	<b>H2</b>	<b>3</b>
<b>60210</b>	<b>10682</b>	<b>60211</b>	<b>5-44</b>	<b>2</b>	<b>H2</b>	<b>3</b>
67572	10692	67571	6-32	2	H1	3
67582	10702	67581	6-32	2	H2	3
<b>60220</b>	<b>10712</b>	<b>60221</b>	<b>6-32</b>	<b>2</b>	<b>H3</b>	<b>3</b>
<b>60230</b>	<b>10722</b>	<b>60231</b>	<b>6-40</b>	<b>2</b>	<b>H2</b>	<b>3</b>
67592	10732	67591	8-32	2	H1	3
67602	10742	67601	8-32	2	H2	3
<b>60240</b>	<b>10752</b>	<b>60241</b>	<b>8-32</b>	<b>2</b>	<b>H3</b>	<b>3</b>
<b>60250</b>	<b>10762</b>	<b>60251</b>	<b>8-36</b>	<b>2</b>	<b>H2</b>	<b>3</b>
67612	10772	67611	10-24	2	H1	3
67622	10782	67621	10-24	2	H2	3
<b>60260</b>	<b>10792</b>	<b>60261</b>	<b>10-24</b>	<b>2</b>	<b>H3</b>	<b>3</b>
67632	10802	67631	10-32	2	H1	3
67642	10812	67641	10-32	2	H2	3
<b>60270</b>	<b>10822</b>	<b>60271</b>	<b>10-32</b>	<b>2</b>	<b>H3</b>	<b>3</b>
<b>60280</b>	<b>10832</b>	<b>60281</b>	<b>12-24</b>	<b>2</b>	<b>H3</b>	<b>3</b>
<b>60290</b>	<b>10842</b>	<b>60291</b>	<b>12-28</b>	<b>2</b>	<b>H3</b>	<b>3</b>
67652	10852	67651	1/4-20	2	H1	3
67662	10862	67661	1/4-20	2	H2	3
<b>60320</b>	<b>10872</b>	<b>60321</b>	<b>1/4-20</b>	<b>2</b>	<b>H3</b>	<b>3</b>
67672	10882	67671	1/4-20	2	H5	3
67682	10892	67681	1/4-20	3	H3	3
67692	10902	67691	1/4-20	3	H5	3
67702	10912	67701	1/4-28	2	H1	3
67712	10922	67711	1/4-28	2	H2	3
<b>60330</b>	<b>10932</b>	<b>60331</b>	<b>1/4-28</b>	<b>2</b>	<b>H3</b>	<b>3</b>

20-AG Part #	20-AGN Part #	20 Part #	Size	# of Flutes	H Limit	Qty. per/pack
67722	10942	67721	1/4-28	2	H4	3
67732	10952	67731	1/4-28	3	H2	3
67742	10962	67741	1/4-28	3	H4	3
67752	10972	67751	5/16-18	2	H1	3
67762	10982	67761	5/16-18	2	H2	3
<b>60340</b>	<b>10992</b>	<b>60341</b>	<b>5/16-18</b>	<b>2</b>	<b>H3</b>	<b>3</b>
67772	11002	67771	5/16-18	2	H5	3
67782	11012	67781	5/16-18	3	H3	3
67792	11022	67791	5/16-18	3	H5	3
67802	11032	67801	5/16-24	2	H1	3
67812	11042	67811	5/16-24	2	H2	3
<b>60350</b>	<b>11052</b>	<b>60351</b>	<b>5/16-24</b>	<b>2</b>	<b>H3</b>	<b>3</b>
67822	11062	67821	5/16-24	2	H4	3
67832	11072	67831	5/16-24	3	H2	3
67842	11082	67841	5/16-24	3	H4	3
67852	11092	67851	3/8-16	3	H1	3
67862	11102	67861	3/8-16	3	H2	3
<b>60360</b>	<b>11112</b>	<b>60361</b>	<b>3/8-16</b>	<b>3</b>	<b>H3</b>	<b>3</b>
67872	11122	67871	3/8-16	3	H5	3
67882	11132	67881	3/8-24	3	H1	3
67892	11142	67891	3/8-24	3	H2	3
<b>60370</b>	<b>11152</b>	<b>60371</b>	<b>3/8-24</b>	<b>3</b>	<b>H3</b>	<b>3</b>
67902	11162	67901	3/8-24	3	H4	3
67912	11172	67911	7/16-14	3	H2	3
<b>60380</b>	<b>11182</b>	<b>60381</b>	<b>7/16-14</b>	<b>3</b>	<b>H3</b>	<b>3</b>
67922	11192	67921	7/16-14	3	H5	3
<b>60390</b>	<b>11202</b>	<b>60391</b>	<b>7/16-20</b>	<b>3</b>	<b>H3</b>	<b>3</b>
67932	11212	67931	7/16-20	3	H5	3
67942	11222	67941	1/2-13	3	H2	3
<b>60400</b>	<b>11232</b>	<b>60401</b>	<b>1/2-13</b>	<b>3</b>	<b>H3</b>	<b>3</b>
67952	11242	67951	1/2-13	3	H5	3
67962	11252	67961	1/2-20	3	H1	3
67972	11262	67971	1/2-20	3	H2	3
<b>60410</b>	<b>11272</b>	<b>60411</b>	<b>1/2-20</b>	<b>3</b>	<b>H3</b>	<b>3</b>
67982	11282	67981	1/2-20	3	H5	3
<b>67992</b>	<b>-----</b>	<b>60461</b>	<b>9/16-12</b>	<b>3</b>	<b>H3</b>	<b>1</b>
<b>68002</b>	<b>-----</b>	<b>60471</b>	<b>9/16-18</b>	<b>3</b>	<b>H3</b>	<b>1</b>
<b>60420</b>	<b>11292</b>	<b>60421</b>	<b>5/8-11</b>	<b>3</b>	<b>H3</b>	<b>1</b>
68012	11302	67991	5/8-11	3	H5	1
<b>60430</b>	<b>11312</b>	<b>60431</b>	<b>5/8-18</b>	<b>3</b>	<b>H3</b>	<b>1</b>
<b>60440</b>	<b>11322</b>	<b>60441</b>	<b>3/4-10</b>	<b>3</b>	<b>H3</b>	<b>1</b>
68022	11332	68001	3/4-10	3	H5	1
<b>60450</b>	<b>11342</b>	<b>60451</b>	<b>3/4-16</b>	<b>3</b>	<b>H3</b>	<b>1</b>

**TYPE 21-AG, TYPE 21-AGN TIN COATED & TYPE 21**

**METRIC - PLUG**

21-AG Part #	21-AGN Part #	21 Part #	Size	# of Flutes	PD Limit	Qty. per/pck
68602	10509	68601	1.6 - 0.35	2	D3	3
68612	10519	68611	1.8 - 0.35	2	D3	3
68622	10529	68621	2.0 - 0.40	2	D3	3
68632	10539	68631	2.20 - 0.45	2	D3	3
60500	10549	68641	2.5 - 0.45	2	D3	3
60510	10559	60102	3.0 - 0.50	2	D3	3
60520	10569	60103	3.5 - 0.60	2	D4	3
60530	10579	60104	4.0 - 0.70	2	D4	3
68642	10589	68651	4.50 - 0.75	2	D4	3
60550	10599	60114	5.0 - 0.80	2	D4	3
60560	10609	60124	6.0 - 1.00	2	D5	3
68652	10619	68661	7.0 - 1.00	2	D5	3

21-AG Part #	21-AGN Part #	21 Part #	Size	# of Flutes	PD Limit	Qty. per/pck
68662	10629	68671	8.0 - 1.00	2	D5	3
60580	10639	60234	8.0 - 1.25	2	D5	3
68672	10649	68681	10.0 - 1.25	3	D5	3
60600	10659	60152	10.0 - 1.50	3	D6	3
68682	10669	68691	12.0 - 1.25	3	D5	3
60620	10679	60162	12.0 - 1.75	3	D6	3
68692	10689	68701	14.0 - 1.50	3	D6	1
60630	10699	60164	14.0 - 2.00	3	D7	1
68702	10709	68711	16.0 - 1.50	3	D6	1
60640	10719	60173	16.0 - 2.00	3	D7	1
60650	10729	60174	18.0 - 2.50	3	D7	1
68712	10739	68721	20.0 - 2.50	3	D7	1

# Taps & Dies

**NORSEMAN/CTD**  
DRILL & TOOL

## HIGH PERFORMANCE REDUCED NECK - SPIRAL POINT TAPS

Machine Screw / Fractional & **METRIC** - Magnum Super Premium

**Type 29-AG - Gold Oxide**

**Type 29-AGN - Titanium Nitride**

- Special tool geometry creates less torque, better removal of chips and runs cooler.
- Designed for difficult materials including: **stainless steel, alloy steels and high carbon steel.**



**Type 29-AG Gold Oxide**

**Gold Oxide** - low temperature stress relief that enhances lubricity, reduces friction and increases tap toughness.



**Type 29-AGN Titanium Nitride**

**Titanium Nitride** - increases wear resistance by producing a higher surface hardness and exceptional lubricity resulting in longer tool life.

**GOLD OXIDE**

**TYPE 29-AG**

**METRIC**

Part #	Size	# of Flutes	H Limits	Qty. per /pack
44264	2-56	2	H2	3
44284	3-48	2	H2	3
44300	4-40	2	H2	3
44294	4-48	2	H2	3
44304	5-40	2	H2	3
44309	5-44	2	H2	3
44310	6-32	3	H3	3
44320	6-40	3	H2	3
44334	8-32	2	H3	3
44330	8-32A	3	H3	3
44344	8-36	2	H2	3
44340	8-36A	3	H2	3
44354	10-24	2	H3	3
44350	10-24A	3	H3	3
44364	10-32	2	H3	3

Part #	Size	# of Flutes	H Limits	Qty. per /pack
44360	10-32A	3	H3	3
44374	12-24	2	H3	3
44370	12-24A	3	H3	3
44384	12-28	2	H3	3
44380	12-28A	3	H3	3
20013	1/4-20	2	H3	3
20010	1/4-20A	3	H3	3
20023	1/4-28	2	H3	3
20020	1/4-28A	3	H2	3
20033	5/16-18	2	H3	3
20030	5/16-18A	3	H3	3
20043	5/16-24	2	H3	3
20040	5/16-24A	3	H2	3
20050	3/8-16	3	H3	3
20060	3/8-24	3	H3	3

Part #	Size	# of Flutes	H Limits	Qty. per /pack
20100	7/16-14	3	H3	3
20110	7/16-20	3	H3	3
20120	1/2-13	3	H3	3
20130	1/2-20	3	H3	3
20163	9/16-12	3	H3	1
20173	9/16-18	3	H3	1
20183	5/8-11	3	H3	1
20193	5/8-18	3	H3	1
20203	3/4-10	3	H3	1
20213	3/4-16	3	H3	1
20223	7/8-9	3	H3	1
20233	7/8-14	3	H3	1
20243	1-8	3	H3	1
20253	1-14	3	H3	1

Part #	Size	# of Flutes	PD Limits	Qty. per /pack
24494	3-.50	2	D3	3
24514	4-.70	3	D4	3
24534	5-.80	3	D4	3
24544	6-1.00	3	D5	3
24574	8-1.25	3	D5	3
24594	10-1.50	3	D6	3
24614	12-1.75	3	D6	3
24634	14-2.00	3	D7	1
24654	16-2.00	3	D7	1

**TITANIUM NITRIDE**

**TYPE 29-AGN**

Part #	Size	# of Flutes	H Limits	Qty. per /pack
09501	2-56	2	H2	3
09511	3-48	2	H2	3
09521	4-40	2	H2	3
09531	4-48	2	H2	3
09541	5-40	2	H2	3
09551	5-44	2	H2	3
09561	6-32	3	H3	3
09571	6-40	3	H2	3
09581	8-32	2	H3	3
09591	8-32A	3	H3	3
09601	8-36	2	H2	3
09611	8-36A	3	H2	3
09621	10-24	2	H3	3
09631	10-24A	3	H3	3
09641	10-32	2	H3	3
09651	10-32A	3	H3	3
09661	12-24	2	H3	3
09671	12-24A	3	H3	3
09681	12-28	2	H3	3

Part #	Size	# of Flutes	H Limits	Qty. per /pack
09691	12-28A	3	H3	3
09701	1/4-20	2	H3	3
09711	1/4-20A	3	H3	3
09721	1/4-28	2	H3	3
09731	1/4-28A	3	H2	3
09741	5/16-18	2	H3	3
09751	5/16-18A	3	H3	3
09761	5/16-24	2	H3	3
09771	5/16-24A	3	H2	3
09781	3/8-16	3	H3	3
09791	3/8-24	3	H3	3
09801	7/16-14	3	H3	3
09811	7/16-20	3	H3	3
09821	1/2-13	3	H3	3
09831	1/2-20	3	H3	3
09841	9/16-12	3	H3	1
09851	9/16-18	3	H3	1
09861	5/8-11	3	H3	1
09871	5/8-18	3	H3	1

Part #	Size	# of Flutes	H Limits	Qty. per /pack
09881	3/4-10	3	H3	1
09891	3/4-16	3	H3	1
09901	7/8-9	3	H3	1
09911	7/8-14	3	H3	1
09921	1-8	3	H3	1
09931	1-14	3	H3	1

**METRIC**

Part #	Size	# of Flutes	PD Limits	Qty. per /pack
09941	3-.50	2	D3	3
09951	4-.70	3	D4	3
09961	5-.80	3	D4	3
09971	6-1.00	3	D5	3
09981	8-1.25	3	D5	3
09991	10-1.50	3	D6	3
10001	12-1.75	3	D6	3
10011	14-2.00	3	D7	1
10021	16-2.00	3	D7	1



**METRIC**

**TiCN / TiAlN**

**Tap & Dies - HSS High Performance Reduced Neck - Spiral Point Taps**

**HIGH PERFORMANCE REDUCED NECK - SPIRAL POINT TAPS**  
**Machine Screw / Fractional & METRIC - Magnum Super Premium**

**Type 29-ACN - Titanium Carbon Nitride**  
**Type 29-ALN - Titanium Aluminum Nitride**

- **Titanium Carbon Nitride** - TiCN coating that is harder than TiN coating resulting in longer tool life and enhanced performance.
- Designed for use in multiple applications.

**Titanium Aluminum Nitride** - TiAlN coating provides extreme toughness, recommended for high temperature operations and difficult to machine materials.

- Designed for hardened steels and cast iron up to 45 Rockwell C.



**TiCN Coating**

**Titanium Carbon Nitride (TiCN)** Hi productivity when threading stainless steel, nickel and aluminum for use in multiple applications



**TiAlN Coating**

**Titanium Aluminum Nitride (TiAlN)** ideal for threading hard materials designed for hardened steels and cast iron up to 45 Rockwell C.

**TITANIUM CARBON NITRIDE**

Part #	Size	# of Flutes	H Limits	Qty. per /pack
31001	2-56	2	H2	3
31011	3-48	2	H2	3
31021	4-40	2	H2	3
31031	4-48	2	H2	3
31041	5-40	2	H2	3
31051	5-44	2	H2	3
31061	6-32	3	H3	3
31071	6-40	3	H2	3
31081	8-32	2	H3	3
31091	8-32A	3	H3	3
31101	8-36	2	H2	3
31111	8-36A	3	H2	3
31121	10-24	2	H3	3
31131	10-24A	3	H3	3
31141	10-32	2	H3	3
31151	10-32A	3	H3	3
31161	12-24	2	H3	3
31171	12-24A	3	H3	3
31181	12-28	2	H3	3

**TYPE 29-ACN**

Part #	Size	# of Flutes	H Limits	Qty. per /pack
31191	12-28A	3	H3	3
31201	1/4-20	2	H3	3
31211	1/4-20A	3	H3	3
31221	1/4-28	2	H3	3
31231	1/4-28A	3	H2	3
31241	5/16-18	2	H3	3
31251	5/16-18A	3	H3	3
31261	5/16-24	2	H3	3
31271	5/16-24A	3	H2	3
31281	3/8-16	3	H3	3
31291	3/8-24	3	H3	3
31301	7/16-14	3	H3	3
31311	7/16-20	3	H3	3
31321	1/2-13	3	H3	3
31331	1/2-20	3	H3	3
31341	9/16-12	3	H3	1
31351	9/16-18	3	H3	1
31361	5/8-11	3	H3	1

Part #	Size	# of Flutes	H Limits	Qty. per /pack
31371	5/8-18	3	H3	1
31381	3/4-10	3	H3	1
31391	3/4-16	3	H3	1
31401	7/8-9	3	H3	1
31411	7/8-14	3	H3	1
31421	1-8	3	H3	1
31431	1-14	3	H3	1

**METRIC**

Part#	Size	# of Flutes	PD Limits	Qty. per /pack
31441	3-.50	2	D3	3
31451	4-.70	3	D4	3
31461	5-.80	3	D4	3
31471	6-1.00	3	D5	3
31481	8-1.25	3	D5	3
31491	10-1.50	3	D6	3
31501	12-1.75	3	D6	3
31511	14-2.00	3	D7	1
31521	16-2.00	3	D7	1

**TITANIUM ALUMINUM NITRIDE**

Part #	Size	# of Flutes	H Limits	Qty. per /pack
56301	2-56	2	H2	3
56311	3-48	2	H2	3
56321	4-40	2	H2	3
56331	4-48	2	H2	3
56341	5-40	2	H2	3
56351	5-44	2	H2	3
56361	6-32	3	H3	3
56371	6-40	3	H2	3
56381	8-32	2	H3	3
56391	8-32A	3	H3	3
56401	8-36	2	H2	3
56411	8-36A	3	H2	3
56421	10-24	2	H3	3
56431	10-24A	3	H3	3
56441	10-32	2	H3	3
56451	10-32A	3	H3	3
56461	12-24	2	H3	3
56471	12-24A	3	H3	3

**TYPE 29-ALN**

Part #	Size	# of Flutes	H Limits	Qty. per /pack
56481	12-28	2	H3	3
56491	12-28A	3	H3	3
56501	1/4-20	2	H3	3
56511	1/4-20A	3	H3	3
56521	1/4-28	2	H3	3
56531	1/4-28A	3	H2	3
56541	5/16-18	2	H3	3
56551	5/16-18A	3	H3	3
56561	5/16-24	2	H3	3
56571	5/16-24A	3	H2	3
56581	3/8-16	3	H3	3
56591	3/8-24	3	H3	3
56601	7/16-14	3	H3	3
56611	7/16-20	3	H3	3
56621	1/2-13	3	H3	3
56631	1/2-20	3	H3	3
56641	9/16-12	3	H3	1
56651	9/16-18	3	H3	1
56661	5/8-11	3	H3	1

Part #	Size	# of Flutes	H Limits	Qty. per /pack
56671	5/8-18	3	H3	1
56681	3/4-10	3	H3	1
56691	3/4-16	3	H3	1
56701	7/8-9	3	H3	1
56711	7/8-14	3	H3	1
56721	1-8	3	H3	1
56731	1-14	3	H3	1

**METRIC**

Part#	Size	# of Flutes	PD Limits	Qty. per /pack
56741	3-.50	2	D3	3
56751	4-.70	3	D4	3
56761	5-.80	3	D4	3
56771	6-1.00	3	D5	3
56781	8-1.25	3	D5	3
56791	10-1.50	3	D6	3
56801	12-1.75	3	D6	3
56811	14-2.00	3	D7	1
56821	16-2.00	3	D7	1

# Taps & Dies

**NORSEMAN/CTD**  
DRILL & TOOL

## M42 COBALT TAPS & TITANIUM NITRIDE NEW

### Type 24-RNC Gold Oxide Type 24-RNCN Titanium Nitride Fractional - Taps for Hardened Steel and Iron

- M-42 plug taps for tapping through holes in mold steel and hardened steel with Rockwell C hardness between C30 – C45.
- Titanium coated M-42 plug taps last twice as long as uncoated taps, titanium coatings lubricity produces smooth threads. For use in cast iron, brass, bronze, armor plate with a Rockwell C hardness between C30 – C45 and hard plastics



Gold Oxide Part #	Titanium Nitride Part #	Thread Size	Thread Length	Overall Length	Shank Diameter	Drill Bit Size	# of Flutes	Pitch Limit Diameter	Qty Per Pack
10052	13802	4-40	5/16"	1-7/8"	0.1405	#43	3	H2	3
10072	13822	5-40	5/16"	1-15/16"	0.1405	#38	3	H2	3
10092	13842	6-32	3/8"	2"	0.1405	#36	3	H3	3
10112	13862	8-32	3/8"	2-1/8"	0.1675	#29	3	H3	3
10132	13882	10-24	1/2"	2-3/8"	0.1935	#25	3	H3	3
10142	13892	10-32	1/2"	2-3/8"	0.1935	#21	3	H3	3
10172	13922	1/4-20	5/8"	2-1/2"	0.2545	#7	3	H3	3
10182	13932	1/4-28	5/8"	2-1/2"	0.2545	#3	3	H3	3
10192	13942	5/16-18	11/16"	2-23/32"	0.3175	F	4	H3	3
10202	13952	5/16-24	11/16"	2-23/32"	0.3175	I	4	H3	3
10212	13962	3/8-16	3/4"	2-15/16"	0.3805	5/16"	4	H3	3
10222	13972	3/8-24	3/4"	2-15/16"	0.3805	Q	4	H3	3
10232	13982	7/16-14	7/8"	3-5/32"	0.3225	U	4	H3	3
10242	13992	7/16-20	7/8"	3-5/32"	0.3225	25/64"	4	H3	3
10272	14002	1/2-13	15/16"	3-3/8"	0.3665	27/64"	4	H3	3
10282	14012	1/2-20	15/16"	3-3/8"	0.3665	29/64"	4	H3	3
10292	14042	5/8-11	1-3/32"	3-13/16"	0.4795	17/32"	4	H3	1
10302	14052	5/8-18	1-3/32"	3-13/16"	0.4795	37/64"	4	H3	1
10312	14062	3/4-10	1-7/32"	4-1/4"	0.5895	21/32"	4	H3	1
10322	14072	3/4-16	1-7/32"	4-1/4"	0.5895	11/16"	4	H3	1

## HSS STRAIGHT FLUTE HAND TAPS

### Machine Screw / Fractional - Ground Thread Types 23-AG, Type 24-AG & Type 25-AG Gold Oxide

### Types 23-AGN, Type 24-AGN & Type 25-AGN Titanium Nitride Types 23, Type 24 & Type 25 Bright Finish

- The most common style of tap
- Can be used by hand or for tapping under power
- Versatile taps for use in general machine tapping or CNC tapping applications
- Use for through hole or blind hole tapping.



**Type 23-AG - Taper**

Gold Oxide - low temperature stress relief that enhances lubricity, reduces friction and increases tap toughness.



**Type 24-AGN - Plug**

Titanium Nitride - increases wear resistance by producing a higher surface hardness and exceptional lubricity resulting in longer tool life.



**Type 25 - Bottoming**  
Bright Finish

23-AG Taper Part#	24-AG Plug Part #	25-AG Bottoming Part #	23-AGN Taper Part #	24-AGN Plug Part #	25-AGN Bottoming Part #	23 Taper Part #	24 Plug Part #	25 Bottoming Part #	Size	# of Flutes	H Limit	QTY per/pack
72701	72702	72703	45981	45982	45983	71661	71662	71663	0-80	2	H1	3
72711	72712	72713	45991	45992	45993	71671	71672	71673	0-80	2	H2	3
72721	72722	72723	44101	44102	44103	71681	71682	71683	1-64	2	H1	3
72731	72732	72733	44111	44112	44113	71691	71692	71693	1-64	2	H2	3
72741	72742	72743	44121	44122	44123	71701	71702	71703	1-72	2	H1	3
72751	72752	72753	44131	44132	44133	71711	71712	71713	1-72	2	H2	3
72761	72762	72763	44141	44142	44143	71721	71722	71723	2-56	3	H1	3
<b>60660</b>	<b>60661</b>	<b>60662</b>	<b>46001</b>	<b>46002</b>	<b>46003</b>	<b>71231</b>	<b>71232</b>	<b>71233</b>	<b>2-56</b>	<b>3</b>	<b>H2</b>	<b>3</b>
72771	72772	72773	44151	44152	44153	71731	71732	71733	2-64	3	H2	3
72781	72782	72783	44161	44162	44163	71741	71742	71743	3-48	3	H1	3
<b>60680</b>	<b>60681</b>	<b>60682</b>	<b>46011</b>	<b>46012</b>	<b>46013</b>	<b>71251</b>	<b>71252</b>	<b>71253</b>	<b>3-48</b>	<b>3</b>	<b>H2</b>	<b>3</b>
60710	60711	60712	45931	45932	45933	71751	71752	71753	3-56	3	H2	3
<b>60700</b>	<b>60701</b>	<b>60702</b>	<b>46021</b>	<b>46022</b>	<b>46023</b>	<b>61001</b>	<b>61002</b>	<b>61003</b>	<b>4-40</b>	<b>3</b>	<b>H2</b>	<b>3</b>
60720	60721	60722	45951	45952	45953	61011	61012	61013	4-48	3	H2	3
72791	72792	72793	44191	44192	44193	71761	71762	71763	5-40	3	H1	3
<b>60730</b>	<b>60731</b>	<b>60732</b>	<b>46031</b>	<b>46032</b>	<b>46033</b>	<b>61021</b>	<b>61022</b>	<b>61023</b>	<b>5-40</b>	<b>3</b>	<b>H2</b>	<b>3</b>
<b>60740</b>	<b>60741</b>	<b>60742</b>	<b>45971</b>	<b>45972</b>	<b>45973</b>	<b>61031</b>	<b>61032</b>	<b>61033</b>	<b>5-44</b>	<b>3</b>	<b>H2</b>	<b>3</b>
72801	72802	72803	44211	44212	44213	71771	71772	71773	6-32	3	H1	3
72811	72812	72813	44221	44222	44223	71781	71782	71783	6-32	3	H2	3
<b>60750</b>	<b>60751</b>	<b>60752</b>	<b>46041</b>	<b>46042</b>	<b>46043</b>	<b>61041</b>	<b>61042</b>	<b>61043</b>	<b>6-32</b>	<b>3</b>	<b>H3</b>	<b>3</b>
72821	72822	72823	44231	44232	44233	71791	71792	71793	6-40	3	H1	3
<b>60760</b>	<b>60761</b>	<b>60762</b>	<b>46051</b>	<b>46052</b>	<b>46053</b>	<b>61051</b>	<b>61052</b>	<b>61053</b>	<b>6-40</b>	<b>3</b>	<b>H2</b>	<b>3</b>
72831	72832	72833	44241	44242	44243	71801	71802	71803	8-32	4	H1	3
72841	72842	72843	44251	44252	44253	71811	71812	71813	8-32	4	H2	3
<b>60770</b>	<b>60771</b>	<b>60772</b>	<b>46061</b>	<b>46062</b>	<b>46063</b>	<b>61061</b>	<b>61062</b>	<b>61063</b>	<b>8-32</b>	<b>4</b>	<b>H3</b>	<b>3</b>
<b>60780</b>	<b>60781</b>	<b>60782</b>	<b>46071</b>	<b>46072</b>	<b>46073</b>	<b>61071</b>	<b>61072</b>	<b>61073</b>	<b>8-36</b>	<b>4</b>	<b>H2</b>	<b>3</b>
72851	72852	72853	44261	44262	44263	71821	71822	71823	10-24	4	H1	3

Red Bold = most common used Taps



**HSS STRAIGHT FLUTE HAND TAPS**  
Machine Screw / Fractional - Ground Thread - Magnum Super Premium

**Types 23-AG, Type 24-AG & Type 25-AG Gold Oxide**  
**Types 23-AGN, Type 24-AGN & Type 25-AGN Titanium Nitride**  
**Types 23, Type 24 & Type 25 Bright Finish**

- The most common style of tap
- Can be used by hand or for tapping under power
- Versatile taps for use in general machine tapping or CNC tapping applications
- Use for through hole or blind hole tapping



**Type 23-AG - Taper**

**Gold Oxide** - low temperature stress relief that enhances lubricity, reduces friction and increases tap toughness.



**Type 24-AGN - Plug**

**Titanium Nitride** - increases wear resistance by producing a higher surface hardness and exceptional lubricity resulting in longer tool life.



**Type 25 - Bottoming**  
**Bright Finish**

**Red Bold** = most common used Taps

23-AG Taper Part#	24-AG Plug Part #	25-AG Bottoming Part #	23-AGN Taper Part #	24-AGN Plug Part #	25-AGN Bottoming Part #	23 Taper Part #	24 Plug Part #	25 Bottoming Part #	Size	# of Flutes	H Limit	QTY per/pack
72861	72862	72863	44271	44272	44273	71831	71832	71833	10-24	4	H2	3
<b>60790</b>	<b>60791</b>	<b>60792</b>	<b>46081</b>	<b>46082</b>	<b>46083</b>	<b>61081</b>	<b>61082</b>	<b>61083</b>	<b>10-24</b>	<b>4</b>	<b>H3</b>	<b>3</b>
72871	72872	72873	44281	44282	44283	71841	71842	71843	10-32	4	H1	3
72881	72882	72883	44291	44292	44293	71851	71852	71853	10-32	4	H2	3
<b>60800</b>	<b>60801</b>	<b>60802</b>	<b>46091</b>	<b>46092</b>	<b>46093</b>	<b>61091</b>	<b>61092</b>	<b>61093</b>	<b>10-32</b>	<b>4</b>	<b>H3</b>	<b>3</b>
<b>60810</b>	<b>60811</b>	<b>60812</b>	<b>46101</b>	<b>46102</b>	<b>46103</b>	<b>61101</b>	<b>61102</b>	<b>61103</b>	<b>12-24</b>	<b>4</b>	<b>H3</b>	<b>3</b>
<b>60820</b>	<b>60821</b>	<b>60822</b>	<b>46111</b>	<b>46112</b>	<b>46113</b>	<b>61111</b>	<b>61112</b>	<b>61113</b>	<b>12-28</b>	<b>4</b>	<b>H3</b>	<b>3</b>
72891	72892	72893	44301	44302	44303	71861	71862	71863	1/4-20	4	H1	3
72901	72902	72903	44311	44312	44313	71871	71872	71873	1/4-20	4	H2	3
<b>60830</b>	<b>60831</b>	<b>60832</b>	<b>46121</b>	<b>46122</b>	<b>46123</b>	<b>61121</b>	<b>61122</b>	<b>61123</b>	<b>1/4-20</b>	<b>4</b>	<b>H3</b>	<b>3</b>
72911	72912	72913	44321	44322	44323	71881	71882	71883	1/4-20	4	H5	3
72921	72922	72923	44331	44332	44333	71891	71892	71893	1/4-28	4	H1	3
72931	72932	72933	44341	44342	44343	71901	71902	71903	1/4-28	4	H2	3
<b>60840</b>	<b>60841</b>	<b>60842</b>	<b>46131</b>	<b>46132</b>	<b>46133</b>	<b>61131</b>	<b>61132</b>	<b>61133</b>	<b>1/4-28</b>	<b>4</b>	<b>H3</b>	<b>3</b>
72941	72942	72943	44351	44352	44353	71911	71912	71913	1/4-28	4	H4	3
72951	72952	72953	44361	44362	44363	71921	71922	71923	5/16-18	4	H2	3
<b>60850</b>	<b>60851</b>	<b>60852</b>	<b>46141</b>	<b>46142</b>	<b>46143</b>	<b>61141</b>	<b>61142</b>	<b>61143</b>	<b>5/16-18</b>	<b>4</b>	<b>H3</b>	<b>3</b>
72961	72962	72963	44371	44372	44373	71931	71932	71933	5/16-18	4	H5	3
72971	72972	72973	44381	44382	44383	71941	71942	71943	5/16-24	4	H2	3
<b>60860</b>	<b>60861</b>	<b>60862</b>	<b>46151</b>	<b>46152</b>	<b>46153</b>	<b>61151</b>	<b>61152</b>	<b>61153</b>	<b>5/16-24</b>	<b>4</b>	<b>H3</b>	<b>3</b>
72981	72982	72983	44391	44392	44393	71951	71952	71953	5/16-24	4	H4	3
72991	72992	72993	44401	44402	44403	71961	71962	71963	3/8-16	4	H1	3
73001	73002	73003	44411	44412	44413	71971	71972	71973	3/8-16	4	H2	3
<b>60870</b>	<b>60871</b>	<b>60872</b>	<b>46161</b>	<b>46162</b>	<b>46163</b>	<b>61161</b>	<b>61162</b>	<b>61163</b>	<b>3/8-16</b>	<b>4</b>	<b>H3</b>	<b>3</b>
73011	73012	73013	44421	44422	44423	71981	71982	71983	3/8-16	4	H5	3
73021	73022	73023	44431	44432	44433	71991	71992	71993	3/8-24	4	H1	3
73031	73032	73033	44441	44442	44443	72001	72002	72003	3/8-24	4	H2	3
<b>60880</b>	<b>60881</b>	<b>60882</b>	<b>46171</b>	<b>46172</b>	<b>46173</b>	<b>61171</b>	<b>61172</b>	<b>61173</b>	<b>3/8-24</b>	<b>4</b>	<b>H3</b>	<b>3</b>
73041	73042	73043	44451	44452	44453	72011	72012	72013	3/8-24	4	H4	3
<b>60890</b>	<b>60891</b>	<b>60892</b>	<b>46181</b>	<b>46182</b>	<b>46183</b>	<b>61181</b>	<b>61182</b>	<b>61183</b>	<b>7/16-14</b>	<b>4</b>	<b>H3</b>	<b>3</b>
73051	73052	73053	44461	44462	44463	72021	72022	72023	7/16-14	4	H5	3
<b>60900</b>	<b>60901</b>	<b>60902</b>	<b>46191</b>	<b>46192</b>	<b>46193</b>	<b>61191</b>	<b>61192</b>	<b>61193</b>	<b>7/16-20</b>	<b>4</b>	<b>H3</b>	<b>3</b>
73061	73062	73063	44471	44472	44473	72031	72032	72033	7/16-20	4	H5	3
73071	73072	73073	44481	44482	44483	72041	72042	72043	1/2-13	4	H1	3
<b>60910</b>	<b>60911</b>	<b>60912</b>	<b>46201</b>	<b>46202</b>	<b>46203</b>	<b>61201</b>	<b>61202</b>	<b>61203</b>	<b>1/2-13</b>	<b>4</b>	<b>H3</b>	<b>3</b>
73081	73082	73083	44491	44492	44493	72051	72052	72053	1/2-13	4	H5	3
73091	73092	73093	44501	44502	44503	72061	72062	72063	1/2-20	4	H1	3
<b>60920</b>	<b>60921</b>	<b>60922</b>	<b>46211</b>	<b>46212</b>	<b>46213</b>	<b>61211</b>	<b>61212</b>	<b>61213</b>	<b>1/2-20</b>	<b>4</b>	<b>H3</b>	<b>3</b>
73101	73102	73103	44511	44512	44513	72071	72072	72073	1/2-20	4	H5	3
<b>60950</b>	<b>60951</b>	<b>60952</b>	<b>46221</b>	<b>46222</b>	<b>46223</b>	<b>55011</b>	<b>55012</b>	<b>55013</b>	<b>9/16-12</b>	<b>4</b>	<b>H3</b>	<b>1</b>

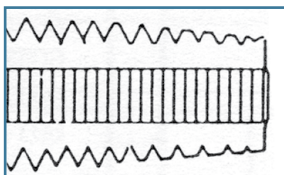

**TAPER**

**Type 23-AG, 23-AGN, 23 Type 31-AG, 31-AGN, 31**

Eight to ten threads chamfered for easy thread starting in tough materials.

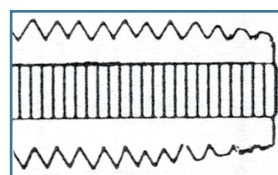

**PLUG**

**Type 24-AG, 24-AGN, 24 Type 32-AG, 32-AGN, 32**

Three to five threads chamfered. For general use when tapping into the bottom of the hole is not critical. (This is the most widely used style.)

**Tap & Dies - HSS Straight Flute Hand Taps**

## HSS STRAIGHT FLUTE HAND TAPS

Machine Screw / Fractional - Ground Thread - Magnum Super Premium

Types 23-AG, Type 24-AG & Type 25-AG - Gold Oxide

Types 23-AGN, Type 24-AGN & Type 25-AGN - Titanium Nitride

Types 23, Type 24 & Type 25 - Bright Finish

- The most common style of tap
- Can be used by hand or for tapping under power
- Versatile taps for use in general machine tapping or CNC tapping applications
- Use for through hole or blind hole tapping



**Type 23-AG - Taper**

Gold Oxide - low temperature stress relief that enhances lubricity, reduces friction and increases tap toughness.



**Type 24-AGN - Plug**

Titanium Nitride- increases wear resistance by producing a higher surface hardness and exceptional lubricity resulting in longer tool life.



**Type 25 - Bottoming  
Bright Finish**

Red Bold = most common used Taps

Taper Part #	Plug Part #	Bottoming Part #	Taper Part #	Plug Part #	Bottoming Part #	Taper Part #	Plug Part #	Bottoming Part #	Size	# of Flutes	H Limit	QTY per/pack
73111	73112	73113	44521	44522	44523	72081	72082	72083	9/16-12	4	H5	1
73121	73122	73123	44531	44532	44533	72091	72092	72093	9/16-18	4	H2	1
<b>60960</b>	<b>60961</b>	<b>60962</b>	<b>46231</b>	<b>46232</b>	<b>46233</b>	<b>55021</b>	<b>55022</b>	<b>55023</b>	<b>9/16-18</b>	<b>4</b>	<b>H3</b>	<b>1</b>
73131	73132	73133	44541	44542	44543	72101	72102	72103	9/16-18	4	H5	1
73141	73142	73143	44551	44552	44553	72111	72112	72113	5/8-11	4	H2	1
<b>60970</b>	<b>60971</b>	<b>60972</b>	<b>46241</b>	<b>46242</b>	<b>46243</b>	<b>55031</b>	<b>55032</b>	<b>55033</b>	<b>5/8-11</b>	<b>4</b>	<b>H3</b>	<b>1</b>
73151	73152	73153	44561	44562	44563	72121	72122	72123	5/8-11	4	H5	1
73161	73162	73163	44571	44572	44573	72131	72132	72133	5/8-18	4	H2	1
<b>60980</b>	<b>60981</b>	<b>60982</b>	<b>46251</b>	<b>46252</b>	<b>46253</b>	<b>55041</b>	<b>55042</b>	<b>55043</b>	<b>5/8-18</b>	<b>4</b>	<b>H3</b>	<b>1</b>
73171	73172	73173	44581	44582	44583	72141	72142	72143	5/8-18	4	H5	1
73181	73182	73183	44591	44592	44593	72151	72152	72153	11/16-11	4	H3	1
73191	73192	73193	44601	44602	44603	72161	72162	72163	11/16-16	4	H3	1
<b>60990</b>	<b>60991</b>	<b>60992</b>	<b>46261</b>	<b>46262</b>	<b>46263</b>	<b>55051</b>	<b>55052</b>	<b>55053</b>	<b>3/4-10</b>	<b>4</b>	<b>H3</b>	<b>1</b>
73201	73202	73203	44611	44612	44613	72171	72172	72173	3/4-10	4	H5	1
73211	73212	73213	44621	44622	44623	72181	72182	72183	3/4-16	4	H1	1
73221	73222	73223	44631	44632	44633	72191	72192	72193	3/4-16	4	H2	1
<b>61400</b>	<b>61401</b>	<b>61402</b>	<b>46271</b>	<b>46272</b>	<b>46273</b>	<b>55061</b>	<b>55062</b>	<b>55063</b>	<b>3/4-16</b>	<b>4</b>	<b>H3</b>	<b>1</b>
73231	73232	73233	44641	44642	44643	72201	72202	72203	3/4-16	4	H5	1
<b>61410</b>	<b>61411</b>	<b>61412</b>	<b>46281</b>	<b>46282</b>	<b>46283</b>	<b>55071</b>	<b>55072</b>	<b>55073</b>	<b>7/8-9</b>	<b>4</b>	<b>H4</b>	<b>1</b>
73241	73242	73243	44651	44652	44653	72211	72212	72213	7/8-9	4	H6	1
73251	73252	73253	44661	44662	44663	72221	72222	72223	7/8-14	4	H2	1
<b>61420</b>	<b>61421</b>	<b>61422</b>	<b>46291</b>	<b>46292</b>	<b>46293</b>	<b>55081</b>	<b>55082</b>	<b>55083</b>	<b>7/8-14</b>	<b>4</b>	<b>H4</b>	<b>1</b>
73261	73262	73263	44671	44672	44673	72231	72232	72233	7/8-14	4	H6	1
<b>61430</b>	<b>61431</b>	<b>61432</b>	<b>46301</b>	<b>46302</b>	<b>46303</b>	<b>55091</b>	<b>55092</b>	<b>55093</b>	<b>1"-8</b>	<b>4</b>	<b>H4</b>	<b>1</b>
73271	73272	73273	44681	44682	44683	72241	72242	72243	1"-8	4	H6	1
61440	61441	61442	46311	46312	46313	55101	55102	55103	1"-12	4	H4	1
27570	27571	27572	46321	46322	46323	55111	55112	55113	1"-14	4	H4	1
61450	61451	61452	46331	46332	46333	55121	55122	55123	1" 1/8-7	4	H4	1
61460	61461	61462	46341	46342	46343	55131	55132	55133	1" 1/8-12	4	H4	1
61470	61471	61472	46351	46352	46353	55141	55142	55143	1" 1/4-7	4	H4	1
61480	61481	61482	46361	46362	46363	55151	55152	55153	1" 1/4-12	6	H4	1
61490	61491	61492	46371	46372	46373	55161	55162	55163	1" 3/8-6	4	H4	1
61500	61501	61502	46381	46382	46383	55171	55172	55173	1" 3/8-12	6	H4	1
61510	61511	61512	46391	46392	46393	55181	55182	55183	1" 1/2-6	4	H4	1
61520	61521	61522	46401	46402	46403	55191	55192	55193	1" 1/2-12	6	H4	1

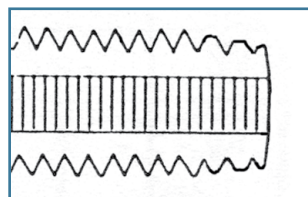

### BOTTOMING

**Type 25-AG, 25-AGN, 25**  
**Type 33-AG, 33-AGN, 33**

One to Two threads chamfered. To use after threads have been started for tapping to the bottom of a hole.

## STRAIGHT FLUTES HAND TAPS SETS

### Straight Flute Hand Taps Machine Screw / Fractional - Taper, Plug, Bottoming Ground Thread - High Speed Steel

- Includes one each Taper, Plug and Bottoming
  - The most common style of tap
  - Can be used by hand or for tapping under power
- Versatile taps for use in general machine tapping or CNC tapping applications
  - Use for through hole or blind hole tapping



#### Type 26-AG - Gold Oxide

Gold Oxide - low temperature stress relief that enhances lubricity, reduces friction and increases tap toughness.

#### Type 26-AGN - Titanium Nitride

TiN coating increases wear resistance by producing a higher surface hardness and exceptional lubricity resulting in longer tool life.

#### Type 26 - Bright Finish

26-AG Gold Oxide Part #	26-AGN Titanium Nitride Part #	Type 26 Bright Part #	Size	# of Flutes	H Limit	Qty. per/pack each
60663	46004	71724	2-56	3	H2	1
60683	46014	71744	3-48	3	H2	1
60703	46024	61004	4-40	3	H2	1
60723	45954	61014	4-48	3	H2	1
60733	46034	61024	5-40	3	H2	1
60743	45974	61034	5-44	3	H2	1
60753	46044	61044	6-32	3	H3	1
60763	46054	61054	6-40	3	H2	1
60773	46064	61064	8-32	4	H3	1
60783	46074	61074	8-36	4	H2	1
60793	46084	61084	10-24	4	H3	1
60803	46094	61094	10-32	4	H3	1
60813	46104	61104	12-24	4	H3	1
60823	46114	61114	12-28	4	H3	1
60833	46124	61124	1/4-20	4	H3	1
60843	46134	61134	1/4-28	4	H3	1
60853	46144	61144	5/16-18	4	H3	1
60863	46154	61154	5/16-24	4	H3	1
60873	46164	61164	3/8-16	4	H3	1
60883	46174	61174	3/8-24	4	H3	1
60893	46184	61184	7/16-14	4	H3	1
60903	46194	61194	7/16-20	4	H3	1
60913	46204	61204	1/2-13	4	H3	1
60923	46214	61214	1/2-20	4	H3	1
60953	46224	55014	9/16-12	4	H3	1
60963	46234	55024	9/16-18	4	H3	1
60973	46244	55034	5/8-11	4	H3	1
60983	46254	55044	5/8-18	4	H3	1
60993	46264	55054	3/4-10	4	H3	1
61403	46274	55064	3/4-16	4	H3	1
61413	46284	55074	7/8-9	4	H4	1
61423	46294	55084	7/8-14	4	H4	1
61433	46304	55094	1"-8	4	H4	1
61443	46314	55104	1"-12	4	H4	1
27573	46324	55114	1"-14	4	H4	1
61453	46334	55124	1 1/8-7	4	H4	1
61463	46344	55134	1 1/8-12	4	H4	1
61473	46354	55144	1 1/4-7	4	H4	1
61483	46364	55154	1 1/4-12	6	H4	1
61493	46374	55164	1 3/8-6	4	H4	1
61503	46384	55174	1 3/8-12	6	H4	1
61513	46394	55184	1 1/2-6	4	H4	1
61523	46404	55194	1 1/2-12	6	H4	1



## METRIC - STRAIGHT FLUTE HAND TAPS

### Straight Flute Hand Taps - Gold Oxide Ground Thread - High Speed Steel

#### Type 31-AG, 31-AGN, 31 -Taper, Type 32-AG, 32-AGN, 32 -Plug Type 33-AG, 33-AGN, 33 -Bottoming

- The most common style of tap
- Can be used by hand or for tapping under power
- Versatile taps for use in general machine tapping or CNC tapping applications
- Use for through hole or blind hole tapping



**Type 31-AG - Taper**

**Gold Oxide** - low temperature stress relief that enhances lubricity, reduces friction and increases tap toughness.



**Type 32-AGN - Plug**

**Titanium Nitride** - increases wear resistance by producing a higher surface hardness and exceptional lubricity resulting in longer tool life..



**Type 33 - Bottoming**

Bright Finish

31-AG Taper Part #	32-AG Plug Part #	33-AG Bottoming Part#	31-AGN Taper Part #	32-AGN Plug Part #	33-AGN Bottoming Part #	31 Taper Part #	32 Plug Part #	33 Bottoming Part #	Size	# of Flutes	PD Limit	QTY. per/pack
60329	61569	61561	-----	-----	-----	54691	54692	54693	1.6-0.35	2	D3	3
60339	61579	61571	-----	-----	-----	54701	54702	54703	1.8-0.35	2	D3	3
60349	61589	61581	-----	-----	-----	54711	54712	54713	2.0-0.40	3	D3	3
60359	61599	61591	-----	-----	-----	54721	54722	54723	2.2-0.45	3	D3	3
60379	61629	61681	37731	37732	37733	54731	54732	54733	2.5-0.45	3	D3	3
60389	61631	61682	37741	37742	37743	54741	54742	54743	3.0-0.50	3	D3	3
60519	61632	61683	37751	37752	37753	54751	54752	54753	3.5-0.60	3	D4	3
60529	61633	61684	37761	37762	37763	54761	54762	54763	4.0-0.70	4	D4	3
60369	61634	61689	37771	37772	37773	54771	54772	54773	4.5-0.75	4	D4	3
60539	61639	61691	37781	37782	37783	54781	54782	54783	5.0-0.80	4	D4	3
60549	61641	61692	37791	37792	37793	54791	54792	54793	6.0-1.00	4	D5	3
60559	61642	61693	37801	37802	37803	54801	54802	54803	7.0-1.00	4	D5	3
60569	61643	61694	37811	37812	37813	54811	54812	54813	8.0-1.00	4	D5	3
60579	61644	61699	37821	37822	37823	54821	54822	54823	8.0-.1.25	4	D5	3
60589	61649	61701	37831	37832	37833	54831	54832	54833	10.0-1.25	4	D5	3
60611	61651	61702	37841	37842	37843	54841	54842	54843	10.0-1.50	4	D6	3
61601	61652	61703	37851	37852	37853	54851	54852	54853	12.0-1.25	4	D5	3
61901	61911	61921	38451	38452	38453	55201	55202	55203	12.0-1.50	4	D5	3
61602	61653	61704	37861	37862	37863	54861	54862	54863	12.0-1.75	4	D6	3
61603	61654	61709	37871	37872	37873	54871	54872	54873	14.0-1.50	4	D6	1
61604	61659	61711	37881	37882	37883	54881	54882	54883	14.0-2.00	4	D7	1
61609	61661	61712	37891	37892	37893	54891	54892	54893	16.0-1.50	4	D6	1
61611	61662	61713	37901	37902	37903	54901	54902	54903	16.0-2.00	4	D7	1
61281	61282	61283	38491	38492	38493	54911	54912	54913	18.0-1.50	4	D6	1
61612	61663	61714	37911	37912	37913	54921	54922	54923	18.0-2.50	4	D7	1
66361	66362	66363	38501	38502	38503	55251	55252	55253	20.0-1.50	4	D6	1
61613	61664	61719	37921	37922	37923	54931	54932	54933	20.0-2.50	4	D7	1
66371	66372	66373	38521	38522	38523	55261	55262	55263	22.0-1.50	4	D6	1
66381	66382	66383	38531	38532	38533	55271	55272	55273	22.0-2.50	4	D7	1
66391	66392	66393	38541	38542	38543	55281	55282	55283	24.0-2.00	4	D7	1
61614	61669	61721	37931	37932	37933	54941	54942	54943	24.0-3.00	4	D8	1
66401	66402	66403	-----	-----	-----	55291	55292	55293	27.0-2.00	4	D7	1
61619	61671	61722	-----	-----	-----	54951	54952	54953	27.0-3.00	4	D8	1
66411	66412	66413	-----	-----	-----	55301	55302	55303	30.0-2.00	4	D7	1
61621	61672	61723	-----	-----	-----	54961	54962	54963	30.0-3.50	4	D9	1
66421	66422	66423	-----	-----	-----	55311	55312	55313	33.0-2.00	6	D7	1
61622	61673	61724	-----	-----	-----	54971	54972	54973	33.0-3.50	4	D9	1
66431	66432	66433	-----	-----	-----	55321	55322	55323	36.0-3.00	4	D8	1
61623	61674	61729	-----	-----	-----	54981	54982	54983	36.0-4.00	4	D9	1
66441	66442	66443	-----	-----	-----	55331	55332	55333	39.0-3.00	6	D8	1
61624	61679	61731	-----	-----	-----	54991	54992	54993	39.0-4.00	6	D9	1

## PRODUCT TIPS

### Tap Wrenches:

They come in two sizes, large & small. Make sure tap is securely locked in place by turning the hex head as tightly as possible with your fingers. Do not use a wrench to tighten.



**Taper Tap**

This section cuts full-size thread



**Plug Tap**

This section cuts full-size thread



**Bottoming Tap**

This section cuts full-size thread

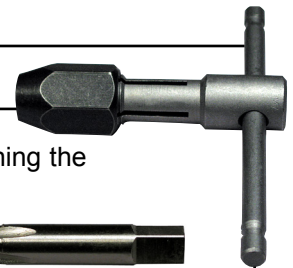



**SETS STRAIGHT FLUTE TAP & TAPER PIPE TAPS**

**Type 35-AG, 35-AGN & Type 35 Sets**  
**Straight Flute Hand Taps - Taper, Plug, Bottoming Ground Thread - High Speed Steel**

- The most common style of tap
- Can be used by hand or for tapping under power
- Versatile taps for use in general machine tapping or CNC tapping applications
- Use for through hole or blind hole tapping

**Type 35-AG - Gold Oxide**  
Gold Oxide - low temperature stress relief that enhances lubricity, reduces friction and increases tap toughness.

**Type 35-AGN - Titanium Nitride**  
TiN coating increases wear resistance by producing a higher surface hardness and exceptional lubricity resulting in longer tool life.

**Type 35 - Bright Finish**

( Includes one each Taper, Plug and Bottoming tap )

35-AG Gold Oxide Part #	35-AGN TiN Coated Part #	Type 35 Bright Part #	Size	# of Flutes	PD Limit	Qty per/pck
61741	37744	54744	3.0-0.50	3	D3	1
61742	37764	54764	4.0-0.70	4	D4	1
61743	37784	54784	5.0-0.80	4	D4	1
61744	37794	54794	6.0-1.00	4	D5	1
61749	37804	54804	7.0-1.00	4	D5	1
61751	37814	54814	8.0-1.00	4	D5	1
61752	37824	54824	8.0-1.25	4	D5	1
61753	37834	54834	10.0-1.25	4	D5	1
61754	37844	54844	10.0-1.50	4	D6	1
61759	37854	54854	12.0-1.25	4	D5	1
61761	37864	54864	12.0-1.75	4	D6	1
61762	37874	54874	14.0-1.50	4	D6	1
61763	37884	54884	14.0-2.00	4	D7	1
61764	37894	54894	16.0-1.50	4	D6	1
61769	37904	54904	16.0-2.00	4	D7	1
61772	37914	54924	18.0-2.50	4	D7	1
61774	37924	54934	20.0-2.50	4	D7	1

**TAPER PIPE TAPS**

**Regular - Type 30-AG, 30-AGN, 30-B & 30**  
**Interrupted - Type I30-AG, I30-AGN, I30-B & I30**

- Regular Thread NPT Taper Pipe taps are used for tapping pipe fittings and couplings in a wide variety of materials.
- Interrupted Thread Taper Pipe taps reduce friction, increase chip capacity, and enhance coolant flow. Recommended for a wide variety of materials including soft ductile materials that produce long stringy chips. ( \*Black Oxide Taper Pipe Tap used on Cast Iron )



Type 30-AG

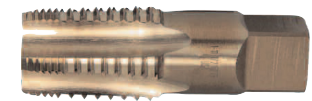

Type I30-AG Interrupted

NPT Regular				NPT INTERRUPTED				Size NPT	# of Flutes	OAL	Shank Diameter	Tap Drill Size	Qty. per/pack
30-AG Gold Oxide Part #	30-AGN TiN Coated Part #	Type 30-B Black Part #	Type 30 Bright Part #	I30-AG Gold Oxide Part #	I30-AGN TiN Coated Part #	*I30-B Black Oxide Part #	I30 Bright Part #						
60570	59343	59342	59341	-----	-----	-----	-----	1/16-27	4	2-1/8"	.3125	D	3
61240	59353	59352	59351	-----	-----	-----	-----	1/8-27(5/16 Shk)	4	2-1/8"	.3125	11/32	3
61250	59363	59362	59361	81410	95722	95771	95770	1/8-27	4	2-1/8"	.4375	11/32	3
61260	59373	59372	59371	81420	95782	95781	95780	1/4-18	4	2-7/16"	.5625	7/16	3
61270	59383	59382	59381	81430	95792	95791	95790	3/8-18	4	2-9/16"	.7000	37/64	1
61280	59393	59392	59391	81440	95802	95801	95800	1/2-14	4	3-1/8"	.6875	23/32	1
61290	59403	59402	59401	81450	95812	95811	95810	3/4-14	5	3-1/4"	.9063	59/64	1
61300	59413	59412	59411	81460	95822	95821	95820	1"- 11 1/2	5	3-3/4"	1.1250	1-5/32	1
61310	59423	59422	59421	81470	95832	95831	95830	1 1/4" - 11 1/2	5	4"	1.3125	1-1/2	1
61320	59433	59432	59431	81480	95842	95841	95840	1 1/2" - 11 1/2	7	4-1/4"	1.500	1-47/64	1
61330	59443	59442	59441	81490	95852	95851	95850	2" - 11 1/2	7	4-1/2"	1.8750	2-7/32	1

METRIC

Taps - Straight Flute Hand Tap Sets & TiN Coated / Taper Pipe Taps

## STRAIGHT FLUTE TAPS - LEFT HAND THREAD

**Type 23L-AG -Taper , Type 24L-AG -Plug , Type 25L-AG -Bottoming**  
Magnum Super Premium

- Special Hi-Tungsten and Hi-Molybdenum tool steels, gold surface treated for maximum lubricity.
- Taper, plug and bottoming styles provide great versatility in tough materials, both blind and through holes.
- For general use in production tapping or left hand tapping operations.



### TYPE 23L-AG TAPER STYLE LEFT HAND THREAD

Part No.	Size	Number of Flutes	GH Limit	Qty. per/pack
60223	6-32	3	3	3
60243	8-32	4	3	3
60263	10-24	4	3	3
60273	10-32	4	3	3
60323	1/4-20	4	3	3
60333	1/4-28	4	3	3
60343	5/16-18	4	3	3
60353	5/16-24	4	3	3
60363	3/8-16	4	3	3
60373	3/8-24	4	3	3
60383	7/16-14	4	3	3
60393	7/16-20	4	3	3
60403	1/2-13	4	3	3
60413	1/2-20	4	3	3
60423	9/16-12	4	3	1
60433	9/16-18	4	3	1
60443	5/8-11	4	3	1
60453	5/8-18	4	3	1
60463	11/16-11	4	3	1
60473	11/16-16	4	3	1
60483	3/4-10	4	3	1
60493	3/4-16	4	3	1
60503	7/8-9	4	4	1
60513	7/8-14	4	4	1
60523	1-8	4	4	1
60533	1-12	4	4	1
60543	1-14	4	4	1
60553	1-1/8-7	4	4	1
60563	1-1/8-12	4	4	1
60573	1-1/4-7	4	4	1
60583	1-1/4-12	6	4	1
60593	1-3/8-6	4	4	1
60603	1-3/8-12	6	4	1
60613	1-1/2-6	6	4	1
60609	1-1/2-12	4	4	1

### TYPE 24L-AG PLUG STYLE LEFT HAND THREAD

Part No.	Size	Number of Flutes	GH Limit	Qty. per/pack
60222	6-32	3	3	3
60242	8-32	4	3	3
60262	10-24	4	3	3
60272	10-32	4	3	3
60322	1/4-20	4	3	3
60332	1/4-28	4	3	3
60342	5/16-18	4	3	3
60352	5/16-24	4	3	3
60362	3/8-16	4	3	3
60372	3/8-24	4	3	3
60382	7/16-14	4	3	3
60392	7/16-20	4	3	3
60402	1/2-13	4	3	3
60412	1/2-20	4	3	3
60422	9/16-12	4	3	1
60432	9/16-18	4	3	1
60442	5/8-11	4	3	1
60452	5/8-18	4	3	1
60462	11/16-11	4	3	1
60472	11/16-16	4	3	1
60482	3/4-10	4	3	1
60492	3/4-16	4	3	1
60502	7/8-9	4	4	1
60512	7/8-14	4	4	1
60522	1-8	4	4	1
60532	1-12	4	4	1
60542	1-14	4	4	1
60552	1-1/8-7	4	4	1
60562	1-1/8-12	4	4	1
60572	1-1/4-7	4	4	1
60582	1-1/4-12	6	4	1
60592	1-3/8-6	4	4	1
60602	1-3/8-12	6	4	1
60612	1-1/2-6	4	4	1
60619	1-1/2-12	6	4	1

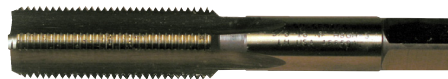

### TYPE 25L-AG BOTTOMING LEFT HAND THREAD

Part No.	Size	Number of Flutes	GH Limit	Qty. per/pack	Part No.	Size	Number of Flutes	GH Limit	Qty. per/pack	Part No.	Size	Number of Flutes	GH Limit	Qty. per/pack
60224	6-32	3	3	3	60404	1/2-13	4	3	3	60524	1-8	4	4	1
60244	8-32	4	3	3	60414	1/2-20	4	3	3	60534	1-12	4	4	1
60264	10-24	4	3	3	60424	9/16-12	4	3	1	60544	1-14	4	4	1
60274	10-32	4	3	3	60434	9/16-18	4	3	1	60554	1-1/8-7	4	4	1
60324	1/4-20	4	3	3	60444	5/8-11	4	3	1	60564	1-1/8-12	4	4	1
60334	1/4-28	4	3	3	60454	5/8-18	4	3	1	60574	1-1/4-7	4	4	1
60344	5/16-18	4	3	3	60464	11/16-11	4	3	1	60584	1-1/4-12	6	4	1
60354	5/16-24	4	3	3	60474	11/16-16	4	3	1	60594	1-3/8-6	4	4	1
60364	3/8-16	4	3	3	60484	3/4-10	4	3	1	60604	1-3/8-12	6	4	1
60374	3/8-24	4	3	3	60494	3/4-16	4	3	1	60614	1-1/2-6	6	4	1
60384	7/16-14	4	3	3	60504	7/8-9	4	4	1	60599	1-1/2-12	4	4	1
60394	7/16-20	4	3	3	60514	7/8-14	4	4	1					

**DRILL & TAP COMBO & SETS**  
Magnum Super Premium

SP-18TD



Includes corresponding drill with tap in a durable metal case.

**TAP & DRILL SETS**

**SP-18TD (SPIRAL POINT, NC)**

Part#	57580	Description of Sizes
190-AG Drill Sizes	#36, 29, 25, 21, 7, F, 5/16, U & 27/64	
20-AG Tap Sizes	6-32, 8-32, 10-24, 10-32, 1/4-20 & 5/16-18, 3/8-16, 7/16-14 & 1/2-13	

**SP-18TDM (SPIRAL POINT, METRIC)**

Part#	57990	Description of Sizes
170-AG Drill Sizes (mm)	2.05, 2.50, 2.90, 3.30, 4.20, 5.00, 6.70, 8.50 & 10.20	
21-AG Tap Sizes (mm)	2.5-.45, 3.0-.50, 3.5-.60, 4.0-.70, 5.0-.80, 6.0-1.00, 8.0-1.25, 10.0-1.50 & 12.0-1.75	

**SP-18TDF (SPIRAL POINT, NF)**

Part#	58010	Description of Sizes
190-AG Drill Sizes	#33, 29, 25, 21, 3, 1, Q, 25/64 & 29/64	
20-AG Tap Sizes	6-40, 8-36, 10-24, 10-32, 1/4-28, 5/16-24, 3/8-24, 7/16-20 & 1/2-20	

**SP-12TD (SPIRAL POINT, NC)**

Part#	58501	Description of Sizes
190-AG Drill Sizes	#36, 29, 25, 21, 7, F	
20-AG Tap Sizes	6-32, 8-32, 10-24, 10-32, 1/4-20 & 5/16-18	

**SF-18TDC (STRAIGHT FLUTE, NC)**

Part#	60930	Description of Sizes
190-AG Drill Sizes	#36, 29, 25, 21, 7, F, 5/16, U & 27/64	
24-AG Tap Sizes	6-32, 8-32, 10-24, 10-32, 1/4-20, 5/16-18, 3/8-16, 7/16-14 & 1/2-13	

**SF-18TDF (STRAIGHT FLUTE, NF)**

Part#	60940	Description of Sizes
190-AG Drill Sizes	#33, 29, 25, 21, 3, 1, Q, 25/64 & 29/64	
24-AG Tap Sizes	6-40, 8-36, 10-24, 10-32, 1/4-28, 5/16-24, 3/8-24, 7/16-20 & 1/2-20	

**SF-10TD (STRAIGHT FLUTE, NC)**

Part#	58500	Description of Sizes
190-AG Drill Size	31/64	
130-AG Drill Sizes	17/32, 21/32, 49/64 & 7/8	
24-AG Tap Sizes	9/16-12, 5/8-11, 3/4-10, 7/8-9 & 1-8	

**B-18TD BRIGHT FINISH 118° POINT - DRILL & TAP COMBO SET**

Part#	60541	Description of Sizes
Type 100 Drill Sizes	#36, 29, 25, 21, 7, F, 5/16, U & 27/64	
Type 20 Tap Sizes	6-32, 8-32, 10-24, 10-32, 1/4-20, 5/16-18, 3/8-16, 7/16-14 & 1/2-13	

**DRILL & TAP COMBO**

**Type 34-AG**

- Includes the correct drill with corresponding size tap on a hanging card.
- Both tools are gold surface treated for maximum lubricity, and precision ground for the ultimate in accuracy and performance.
- Hi-Molybdenum super premium twist drill combined with the corresponding Hi-Tungsten Magnum spiral point tap.

Part No.	Thread Size	Drill Size	Part No.	Thread Size	Drill Size
51807	6-32	36	51897	1/4-28	3
51817	6-40	33	51907	5/16-18	F
51827	8-32	29	51917	5/16-24	I
51837	8-36	29	51927	3/8-16	5/16
51847	10-24	25	51937	3/8-24	Q
51857	10-32	21	51947	7/16-14	U
51867	12-24	16	51957	7/16-20	25/64
51877	12-28	14	51967	1/2-13	27/64
51887	1/4-20	7	51977	1/2-20	29/64

Carded Hanging Display page 66

**HSS Taps**

**COMBINATION DRILL & TAP**  
**Type 40-AG**

**NEW**

- Hi-Molybdenum tool steel ensures longer tool life.
- Combination drill and taps are ideally suited for on-site tapping in construction, maintenance and repair, assembly, production environments.
- The self-centering split point provides excellent drilling precision and accuracy.



Pitch Diameter and Thread tolerances are designed to produce a Class 2B fit.

Part #	Size	Max Material Thickness	Thread Length
73770	4-40	0.368	0.564
73780	4-48	0.369	0.564
73790	5-40	0.403	0.624
73800	5-44	0.404	0.624
73810	6-32	0.468	0.376
73820	6-40	0.470	0.376
73830	8-32	0.539	0.376
73840	8-36	0.540	0.376
73850	10-24	0.606	0.496
73860	10-32	0.608	0.496
73870	12-24	0.677	0.496
73880	12-28	0.678	0.496
73890	1/4-20	0.746	0.626
73900	1/4-28	0.750	0.626
73910	5/16-18	0.889	0.683
73920	5/16-24	0.893	0.683
73930	3/8-16	1.031	0.746
73940	3/8-24	1.036	0.746
73950	7/16-14	1.172	0.882
73960	7/16-20	1.178	0.880
73970	1/2-13	1.378	0.940
73980	1/2-20	1.384	0.940
75540	9/16-12	1.395	0.940
75550	9/16-18	1.403	0.940
75560	5/8-11	1.412	0.940
75570	5/8-18	1.421	0.940

Pitch Diameter and Thread tolerances are designed to produce a Class 6H fit.

Part #	MM Size	Max Material Thickness	Thread Length
85921	3.0 x 0.5	0.403	0.624
85931	4.0 x 0.7	0.538	0.376
85941	5.0 x 0.8	0.610	0.496
85951	6.0 x 1.00	0.746	0.626
85961	7.0 x 1.00	0.882	0.686
85971	8.0 x 1.25	0.892	0.686
85991	10.0 x 1.50	1.037	0.746
86001	12.0 x 1.75	1.373	0.942

Part#	SETS	Description of Sizes
21330	40-AG - DT-6	6pc. set 6-32, 8-32, 10-24, 10-32, 12-24, 1/4-20
73991	40-AG - DT-7F	7pc. set 8-36, 10-32, 1/4-28, 5/16-24, 3/8-24, 7/16-20, 1/2-20
73990	40-AG - DT-7C	7pc. set 8-32, 10-24, 1/4-20, 5/16-18, 3/8-16, 7/16-14, 1/2-13

**1/4" QUICK RELEASE DRILL & TAP COMBO**  
**Type 40-QR**

**NEW**



- Hi-Molybdenum tool steel ensures longer tool life.
- Combination drill and taps are ideally suited for on-site tapping in construction, maintenance and repair, assembly, production environments.



Pitch Diameter and Thread tolerances are designed to produce a Class 2B fit.

Part#	Size	Max Material Thickness	Thread Length
73814	6-32	0.170	0.283
73834	8-32	0.200	0.283
73854	10-24	0.200	0.363
73864	10-32	0.200	0.363
73874	12-24	0.200	0.369
73894	1/4-20	0.230	0.326
73904	1/4-28	0.230	0.326
73914	5/16-18	0.480	0.614
73934	3/8-16	0.480	0.585

Pitch Diameter and Thread tolerances are designed to produce a Class 6H fit.

Part #	MM Size	Max Material Thickness	Thread Length
85924	3.0 x 0.50	0.170	0.334
85934	4.0 x 0.70	0.170	0.269
85944	5.0 x 0.80	0.200	0.404
85954	6.0 x 1.00	0.230	0.376
85974	8.0 x 1.25	0.480	0.638
85994	10.0 x 1.50	0.480	0.595

Part#	SET	Description of Sizes
21324	40-QR DT-5	5pc. set 6-32, 8-32, 10-24, 10-32, 1/4-20

# HSS Taps & Dies

**NORSEMAN/CTD**  
DRILL & TOOL

## HSS TAP SETS, HEX DIES - METRIC & CARDED HANGING DISPLAY

### Carded Hanging Display

38 Piece MRO Pro-Pack Drilling & Tapping Combo Carded Super Premium Black & Gold Twist Drill combined with the Corresponding Hi-Tungsten Spiral Point Gold Tap.

**Part No. 52001**

One Each of	Two Each of	Three Each of	Four Each of
6-32	8-32	5/16-18	1/4-20
6-40	8-36	3/8-16	
12-24	10-24	7/16-14	
12-28	10-32	1/2-13	
	1/4-28		
	5/16-24		
	3/8-24		
	7/16-20		
	1/2-20		

### HSS TAP SETS - METRIC

#### Magnum Super Premium

- Straight flute or spiral point taps in rugged black steel index.



#### SPIRAL & STRAIGHT FLUTE TAP SETS

#### SP-19T - Type 20-AG - Spiral Point

Part No.	Sizes
61600	0-80, 1-64, 1-72, 2-56, 2-64, 3-48, 3-56, 4-40, 4-48, 5-40, 5-44, 6-32, 6-40, 8-32, 8-36, 10-24, 10-32, 12-24 & 12-28

#### SP-10T - Type 20-AG - Spiral Point

Part No.	Sizes
61610	1/4-20, 1/4-28, 5/16-18, 5/16-24, 3/8-16, 3/8-24, 7/16-14, 7/16-20, 1/2-13 & 1/2-20

#### SF-10T - Type 24-AG - Straight Flute

Part No.	Sizes
61620	1/4-20, 1/4-28, 5/16-18, 5/16-24, 3/8-16, 3/8-24, 7/16-14, 7/16-20, 1/2-13 & 1/2-20

### 12pc. Drill, Tap & Countersink Set Type TDC-12



Part No.	Sizes
20470	Type 190-AG: Wire:#7, 21, 25, 29 and 36 Type 20-AG: 6-32, 8/32, 10-24, 10-32 and 1/4-20 Type 82-AG: No. 8 screw size and 3/16-17/32 range cut

### HIGH-SPEED STEEL HEX DIES

#### Type 27-AG

#### Magnum Super Premium Dies

- Special Hi-Molybdenum tool steel, polished gold finish with black surface treated threads for long life and rich appearance.
- These dies are used for threading rods, bolts, studs and other pieces requiring external threads.
- The outside hex configuration allows both wrench and die stock use in threading.



Part No.	Size	Across Flats	Qty. per/pack
61000	4-40	1"	3
61010	6-32	1"	3
61020	8-32	1"	3
61030	10-24	1"	3
61040	10-32	1"	3
61050	12-24	1"	3
61060	1/4-20	1"	3
61070	1/4-28	1"	3
61080	5/16-18	1"	3
61090	5/16-24	1"	3
61100	3/8-16	1"	3
61110	3/8-24	1"	3
61120	7/16-14	1"	3
61130	7/16-20	1"	3
61140	1/2-13	1"	3
61150	1/2-20	1"	3
61160	9/16-12	1-7/16"	1
61170	9/16-18	1-7/16"	1
61180	5/8-11	1-7/16"	1
61190	5/8-18	1-7/16"	1
61200	3/4-10	1-7/16"	1
61210	3/4-16	1-7/16"	1
61220	1/8-27	1"	1
61230	1/4-18	1-7/16"	1

#### METRIC

Part No.	Size	Across Flats	Qty. per/pack
60511	3.0 x 0.50	1"	3
60521	3.5 x 0.60	1"	3
60531	4.0 x 0.70	1"	3
60551	5.0 x 0.80	1"	3
60561	6.0 x 1.00	1"	3
60581	8.0 x 1.25	1"	3
60601	10.0 x 1.50	1"	3
60621	12.0 x 1.75	1-7/16"	1
60622	14.0 x 1.50	1-7/16"	1

**25PC / 23PC / 15PC / 14PC HSS TAP & DIE ASSORTMENTS**

**25pc. Magnum Super Premium Set**  
**Spiral point Plug Taps & Hex Dies**

Set contains: Type 20-AG and 27-AG

- HSS spiral point taps & HSS hex dies sizes: 1/4-20, 1/4-28, 5/16-18, 5/16-24, 3/8-16, 3/8-24, 7/16-14, 7/16-20, 1/2-13 & 1/2-20
- HSS pipe tap and hex die size: 1/8-27 NPT.
- T-Handle tap wrench: 3/16" - 1/2"
- Die stock & Screw pitch gauge
- SP-25TDI

Supplied in sturdy plastic case

**PART NO. 35173**



**Part # 35173**

**23pc. Magnum Super Premium Set - Metric**  
**Spiral point Taps & Hex Dies**

Set contains: Type 21-AG and 27-AG

- HSS spiral point taps & HSS hex dies sizes: 3.0-.50, 3.5-.60, 4.0-.70, 5.0-.80, 6.0-1.00, 8.0-1.25, 10.0-1.50 & 12.0-1.75
- HSS pipe tap and hex die size: 1/8-27 NPT
- T-Handle tap wrenches: 0 - 1/4" & 3/16" - 1/2"
- Straight handle tap wrench: #4 - 1/2"
- Die stock & Screw metric pitch gauge
- SP-23TDI

Supplied in sturdy plastic case

**PART NO. 35170**

**15pc. Magnum Super Premium Set**  
**Spiral point Plug Taps & Hex Dies**

Set contains: Type 20-AG and 27-AG

- HSS spiral point taps & HSS hex dies sizes: 6-32, 8-32, 10-24, 10-32, 12-24 & 1/4-20
- T-Handle tap wrench: 0 - 1/4"
- Economy die stock & Screw pitch gauge
- SP-15TDI

Supplied in sturdy plastic case

**PART NO. 35174**

**14pc. Magnum Super Premium Set - Metric**  
**Spiral point Taps & Hex Dies**

Set contains: Type 21-AG and 27-AG

- HSS spiral point taps sizes: 2.5-.45, 3.0-.50, 3.5-.60, 4.0-.70, 5.0-.80 & 6.0-1.00.
- HSS hex dies sizes: 3.0-.50, 3.5-.60, 4.0-.70, 5.0-.80 & 6.0-1.00.
- T-Handle tap wrench: 0 - 1/4".
- SP-14TDI

Economy die stock & Screw metric pitch gauge.

Supplied in sturdy plastic case.

**PART NO. 35172**

## 58 PC & 40 PC HSS TAPS & DIE ASSORTMENTS

- Special Hi -Tungsten and Hi -Molybdenum tool steels, gold oxide for maximum lubricity.
- Recommended for use in production tapping and drilling in work hardening grades of stainless steel and other hard metal applications.
- Precision ground tap threads for the ultimate in accuracy and performance.



**Part # 61680**

### 58pc. Magnum Super Premium Set Straight Flute Plug Taps & Hex Dies

**Set contains: Type 24-AG and 27-AG**

- HSS straight flute taps & HSS hex dies sizes: 6-32, 8-32, 10-24, 10-32, 12-24, 1/4-20, 1/4-28, 5/16-18, 5/16-24, 3/8-16, 3/8-24, 7/16-14, 7/16-20, 1/2-13, 1/2-20, 9/16-12, 9/16-18, 5/8-11, 5/8-18, 3/4-10, 3/4-16, 1/8-27NPT & 1/4-18NPT
- Straight handle tap wrenches: #4-1/2" & 1/4" - 3/4"
  - Die stocks: MED R/H & 1" R/H
  - T-handle tap wrench: 0 - 1/4"
    - Screw pitch gauge
- Screw driver & Spiral flute extractors sizes: Ex 1 thru Ex 5
  - SF-58TDI

*Supplied in sturdy plastic case*

**PART NO. 61680**

### 40pc. Magnum Super Premium Set Straight Flute Plug Taps & Hex Dies

**Set contains: Type 24-AG and 27-AG**

- HSS straight flute taps & HSS hex dies sizes: 4-40, 6-32, 8-32, 10-24, 10-32, 12-24, 1/4-20, 1/4-28, 5/16-18, 5/16-24, 3/8-16, 3/8-24, 7/16-14, 7/16-20, 1/2-13 & 1/2-20.
  - HSS pipe tap and hex die size: 1/8-27 NPT
- T-Handle tap wrenches: 0 - 1/4" & 3/16" - 1/2"
  - Straight handle tap wrench: #4 - 1/2"
- Die stock, Screw pitch gauge & Screw driver
  - SF-40TDI

*Supplied in sturdy plastic case*

**PART NO. 35171**



**Part # 35171**

### 40pc. Magnum Super Premium Set Spiral point Plug Taps & Hex Dies

**Set contains: Type 20-AG and 27-AG**

- HSS spiral point taps & HSS hex dies sizes: 4-40, 6-32, 8-32, 10-24, 10-32, 12-24, 1/4-20, 1/4-28, 5/16-18, 5/16-24, 3/8-16, 3/8-24, 7/16-14, 7/16-20, 1/2-13 & 1/2-20.
  - HSS pipe tap and hex die size: 1/8-27 NPT
- T-Handle tap wrenches: 0 - 1/4" & 3/16" - 1/2"
  - Straight handle tap wrench: #4 - 1/2"
- Die stock, Screw pitch gauge & Screw driver
  - SP-40TDI

*Supplied in sturdy plastic case*

**PART NO. 35181**

## HI-CARBON STEEL TAPS - U.S. SIZES ( PLUG & TAPER )

**Type 720 Plug Fractional , Type 721 Plug Machine Screw**

**Type 740 Taper Fractional , Type 741 Taper Machine Screw**

- Made of super tough carbon steel, these taps are ideal for hand tapping and re-threading applications.



### TYPE 720 -PLUG FRACTIONAL

Part No.	Size	Tap Drill Size	No. of Flutes	Qty. per/pack
55010	3/16x24	26	4	3
55020	3/16x32	22	4	3
55030	1/4x20	7	4	3
55040	1/4x28	3	4	3
55050	5/16x18	17/64	4	3
55060	5/16x24	17/64	4	3
55070	3/8x16	5/16	4	3
55080	3/8x24	21/64	4	3
55090	7/16x14	3/8	4	3
55100	7/16x20	25/64	4	3
55110	1/2x13	27/64	4	3
55120	1/2x20	29/64	4	3
55130	9/16x12	31/64	4	1
55140	9/16x18	33/64	4	1
55150	5/8x11	17/32	4	1
55720	5/8x18	37/64	4	1
55730	11/16x11	19/32	4	1
55740	11/16x16	5/8	4	1
55160	3/4x10	21/32	4	1
55890	3/4x16	11/16	4	1
55170	7/8x9	49/64	4	1
55180	7/8x14	13/16	4	1
55190	1x8	7/8	4	1
55200	1x12	29/32	4	1
55210	1x14	15/16	4	1

### TYPE 740 -TAPER FRACTIONAL

Part No.	Size	Tap Drill Size	No. of Flutes	Qty. per/pack
55250	3/16x24	26	4	3
55260	3/16x32	22	4	3
55270	1/4x20	7	4	3
55280	1/4x28	3	4	3
55290	5/16x18	17/64	4	3
55300	5/16x24	17/64	4	3
55310	3/8x16	5/16	4	3
55320	3/8x24	21/64	4	3
55330	7/16x14	3/8	4	3
55340	7/16x20	25/64	4	3
55350	1/2x13	27/64	4	3
55360	1/2x20	29/64	4	3
55370	9/16x12	31/64	4	1
55380	9/16x18	33/64	4	1
55390	5/8x11	17/32	4	1
55460	5/8x18	37/64	4	1
55470	11/16x11	19/32	4	1
55480	11/16x16	5/8	4	1
55400	3/4x10	21/32	4	1
55710	3/4x16	11/16	4	1
55410	7/8x9	49/64	4	1
55420	7/8x14	13/16	4	1
55430	1x8	7/8	4	1
55440	1x12	29/32	4	1
55450	1x14	15/16	4	1

### TYPE 721 -PLUG MACHINE SCREW

Part No.	Size	Tap Drill Size	No. of Flutes	Qty. per/pack
54860	0x80	3/64	3	3
54870	1x64	53	3	3
54880	1x72	53	3	3
54890	2x56	50	3	3
54900	2x64	50	3	3
54910	3x48	47	3	3
54920	3x56	46	3	3
55750	4x36	43	3	3
55760	4x40	44	3	3
55770	5x40	38	3	3
55780	6x32	36	3	3
55790	6x40	34	3	3
55800	6x48	32	3	3
55810	8x32	29	3	3
55820	8x36	29	3	3
55830	8x40	28	3	3
55840	10x24	25	3	3
55850	10x32	21	3	3
55860	12x24	16	3	3
55870	12x28	16	3	3
55880	14x20	10	3	3

### TYPE 741 -TAPER MACHINE SCREW

Part No.	Size	Tap Drill Size	No. of Flutes	Qty. per/pack
54790	0X80	3/64	3	3
54800	1X64	53	3	3
54810	1X72	53	3	3
54820	2X56	50	3	3
54830	2X64	50	3	3
54840	3X48	47	3	3
54850	3X56	46	3	3
55900	4x36	43	3	3
55910	4x40	44	3	3
55920	5x40	38	3	3
55930	6x32	36	3	3
55940	6x40	34	3	3
55950	6x48	32	3	3
55960	8x32	29	3	3
55970	8x36	29	3	3
55980	8x40	28	3	3
55990	10x24	25	3	3
56000	10x32	21	3	3
56010	12x24	16	3	3
56020	12x28	16	3	3
56030	14x20	10	3	3

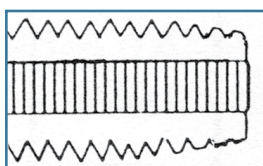

#### PLUG - Type 720 & 721

Three to five threads chamfered. For general use when tapping into the bottom of the hole is not critical.

(This is the most widely used style.)

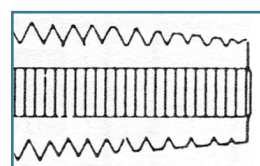

#### TAPER - Type 740 & 741

Seven to ten threads chamfered for easy use thread starting in tough materials.



## HI-CARBON STEEL TAPS - U.S. SIZES (BOTTOMING & 3 Piece SETS)

**Type 760 -Bottoming -Fractional, Type 761 -Bottoming -Machine Screw**  
**Type 722 -3 pcs. Sets -Fractional, Type 723 -3 pcs. Sets -Machine Screw**



Bottoming - Type 761

### TYPE 760 BOTTOMING FRACTIONAL

Part No.	Size	Tap Drill Size	No. of Flutes	Qty. per/pack
55500	3/16x24	26	4	3
55510	3/16x32	22	4	3
55520	1/4x20	7	4	3
55530	1/4x28	3	4	3
55540	5/16x18	17/64	4	3
55550	5/16x24	17/64	4	3
55560	3/8x16	5/16	4	3
55570	3/8x24	21/64	4	3
55580	7/16x14	3/8	4	3
55590	7/16x20	25/64	4	3
55600	1/2x13	27/64	4	3
55610	1/2x20	29/64	4	3
55620	9/16x12	31/64	4	1
55630	9/16x18	33/64	4	1
55640	5/8x11	17/32	4	1
56040	5/8x18	37/64	4	1
56050	11/16x11	19/32	4	1
56060	11/16x16	5/8	4	1
55650	3/4x10	21/32	4	1
56070	3/4x16	11/16	4	1
55660	7/8x9	49/64	4	1
55670	7/8x14	13/16	4	1
55680	1x8	7/8	4	1
55690	1x12	29/32	4	1
55700	1x14	15/16	4	1

These items are also available carded. See Price List Catalog for details.

### 3 PC. SETS TYPE 722 FRACTIONAL

Part No.	Size	Tap Drill Size	No. of Flutes	Qty. per/pack
56300	3/16x24	26	4	1
56310	3/16x32	22	4	1
56320	1/4x20	7	4	1
56330	1/4x28	3	4	1
56340	5/16x18	17/64	4	1
56350	5/16x24	17/64	4	1
56360	3/8x16	5/16	4	1
56370	3/8x24	21/64	4	1
56380	7/16x14	3/8	4	1
56390	7/16x20	25/64	4	1
56400	1/2x13	27/64	4	1
56410	1/2x20	29/64	4	1
56420	9/16x12	31/64	4	1
56430	9/16x18	33/64	4	1
56440	5/8x11	17/32	4	1
56590	5/8x18	37/64	4	1
56740	11/16x11	19/32	4	1
56750	11/16x16	5/8	4	1
56450	3/4x10	21/32	4	1
56760	3/4x16	11/16	4	1
56460	7/8x9	49/64	4	1
56470	7/8x14	13/16	4	1
56480	1x8	7/8	4	1
56490	1x12	29/32	4	1
56500	1x14	15/16	4	1

Includes one of each same size Taper, Plug and Bottoming taps

### TYPE 761 BOTTOMING - MACHINE SCREW

Part No.	Size	Tap Drill Size	No. of Flutes	Qty. per/pack
54930	0x80	3/64	3	3
54940	1x64	53	3	3
54950	1x72	53	3	3
54960	2x56	50	3	3
54970	2x64	50	3	3
54980	3x48	47	3	3
54990	3x56	46	3	3
56100	4x36	43	3	3
56110	4x40	44	3	3
56120	5x40	38	3	3
56130	6x32	36	3	3
56140	6x40	34	3	3
56150	6x48	32	3	3
56160	8x32	29	4	3
56170	8x36	29	4	3
56180	8x40	28	4	3
56190	10x24	25	4	3
56200	10x32	21	4	3
56210	12x24	16	4	3
56220	12x28	16	4	3
56230	14x20	10	4	3

These items are also available carded. See Price List Catalog for details.

### 3 PC. SETS TYPE 723 MACHINE SCREW

Part No.	Size	Tap Drill Size	No. of Flutes	Qty. per/pack
56600	4x36	43	3	1
56610	4x40	44	3	1
56620	5x40	38	3	1
56630	6x32	36	3	1
56640	6x40	34	3	1
56650	6x48	32	3	1
56660	8x32	29	4	1
56670	8x36	29	4	1
56680	8x40	28	4	1
56690	10x24	25	4	1
56700	10x32	21	4	1
56710	12x24	16	4	1
56720	12x28	16	4	1
56730	14x20	10	4	1

Includes one of each same size Taper, Plug and Bottoming taps.

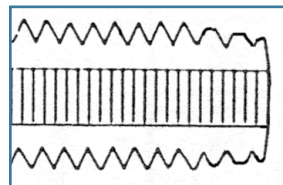

### BOTTOMING Type 760 & 761

One to Two threads chamfered. To use after threads have been started for tapping to the bottom of a hole.

## HI- CARBON STEEL DIES - HEX DIES

### Type 405 -Machine Screw & Fractional sizes , Type 790 -Metric

- These dies are made of high quality carbon tool steel and meet the highest industry standards.
- A complete selection of solid round, adjustable round, and solid hex dies for right hand threads is available.
- Select sizes of dies may be imported.

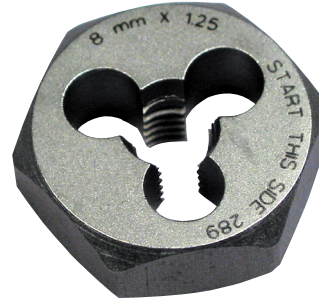

#### TYPE 405 MACHINE SCREW & FRACTIONAL SIZES

Part No.	Size	Across Flats	Qty. per/pack
86000	4x40	1"	3
86010	4x36	1"	3
86020	5x40	1"	3
86030	6x32	1"	3
86040	8x32	1"	3
86050	10x24	1"	3
86060	10x32	1"	3
86070	12x24	1"	3
86080	14x20	1"	3
86100	3/16x24	1"	3
86110	3/16x32	1"	3
86120	1/4x20	1"	3
86130	1/4x28	1"	3
86140	5/16x18	1"	3
86150	5/16x24	1"	3
86160	3/8x16	1"	3
86170	3/8x24	1"	3
86180	7/16x14	1"	3
86190	7/16x20	1"	3
86200	1/2x13	1"	3
86210	1/2x20	1"	3
86220	9/16x12	1-7/16"	1
86230	9/16x18	1-7/16"	1
86240	5/8x11	1-7/16"	1
86250	5/8x18	1-7/16"	1
86260	11/16x11	1-7/16"	1
86270	11/16x16	1-7/16"	1
86280	3/4x10	1-7/16"	1
86290	3/4x16	1-7/16"	1
86300	7/8x9	1-5/8"	1
86310	7/8x14	1-5/8"	1
86320	1x8	1-13/16"	1
86330	1x12	1-13/16"	1
86340	1x14	1-13/16"	1
86350	1/8x27	1"	1
86360	1/4x18	1"	1
86380	3/8x18	1-7/16"	1
86390	1/2x14	1-5/8"	1
86420	3/4x14	2"	1
86430	1-11x1/2"	2-3/8"	1

#### TYPE 790 METRIC SIZES

Part No.	Size	Size Across Flats	Qty. per/pack
84000	3x.50	1"	3
84010	3x.60	1"	3
84020	4x.70	1"	3
84030	4x.75	1"	3
84040	5x.80	1"	3
84050	5x.90	1"	3
84060	6x1.00	1"	3
84070	7x1.00	1"	3
84270	8x1.00	1"	3
84080	8x1.25	1"	3
84090	9x1.00	1"	3
84100	9x1.25	1"	3
84110	10x1.00	1"	3
84120	10x1.25	1"	3
84130	10x1.50	1"	3
84140	11x1.50	1"	3
84280	12x1.25	1"	3
84150	12x1.50	1"	3
84160	12x1.75	1"	3
84170	14x1.25	1-7/16"	1
84290	14x1.50	1-7/16"	1
84180	14x2.00	1-7/16"	1
84190	16x1.50	1-7/16"	1
84200	16x2.00	1-7/16"	1
84210	18x1.50	1-7/16"	1
84300	18x2.00	1-7/16"	1
84220	18x2.50	1-7/16"	1

These items are also available carded.  
See Price List Catalog for details.

#### HEXAGONAL DIES: TIPS

Carbon steel dies are primarily used for restoring damaged threads. Hex shape allows them to be driven in cramped quarters with a wrench.

## HI-CARBON STEEL DIES - ADJUSTABLE & ROUND

### Type 415 -Adjustable , Type 400 -Round

- These dies are made of high quality carbon tool steel and meet the highest industry standards.
- We offer a complete selection of solid round and adjustable round for right hand threads.
- Select sizes of dies may be imported.

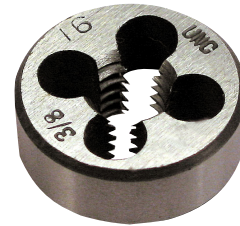

**TYPE 415 -ADJUSTABLE** MACHINE SCREW & FRACTIONAL

Part No.	Size	O.D.	Qty. per/pack
85000	0x80	1"	3
85010	1x64	1"	3
85020	1x72	1"	3
85030	2x56	1"	3
85040	2x64	1"	3
85050	3x48	1"	3
85060	3x56	1"	3
85070	4x40	1"	3
85080	4x36	1"	3
85090	5x40	1"	3
85100	6x32	1"	3
85110	8x32	1"	3
85120	10x24	1"	3
85130	10x32	1"	3
85140	12x24	1"	3
85150	14x20	1"	3
85170	3/16x24	1"	3
85180	3/16x32	1"	3
85190	1/4x20	1"	3
85200	1/4x28	1"	3
85210	5/16x18	1"	3
85220	5/16x24	1"	3
85230	3/8x14	1"	3
85240	3/8x24	1"	3
85250	7/16x14	1"	3
85260	7/16x20	1"	3
85270	1/2x13	1"	3
85280	1/2x20	1"	3
85290	9/16x12	1-1/2"	1
85300	9/16x18	1-1/2"	1
85310	5/8x11	1-1/2"	1
85320	5/8x18	1-1/2"	1
85330	11/16x11	2"	1
85340	11/16x16	1-1/2"	1
85350	3/4x10	2"	1
85360	3/4x16	2"	1
85370	7/8x9	2"	1
85380	7/8x14	2"	1
85390	1x8	2"	1
85400	1x12	2"	1
85410	1x14	2"	1
85420	1/8x27	1"	3
85430	1/4x18	1-1/2"	1
85440	3/8x18	1-1/2"	1
85450	1/2x14	1-1/2"	1

These items are also available carded. See Price List Catalog for details.

**TYPE 400 -ROUND** MACHINE SCREW & FRACTIONAL

Part No.	Size	O.D.	Qty. per/pack
53600	4x36	1"	3
53610	4x40	1"	3
53620	5x40	1"	3
53630	6x32	1"	3
53640	8x32	1"	3
53650	10x24	1"	3
53660	10x32	1"	3
53670	12x24	1"	3
53680	14x20	1"	3
53690	3/16x24	1"	3
53700	3/16x32	1"	3
53710	1/4x20	1"	3
53720	1/4x28	1"	3
53730	5/16x18	1"	3
53820	5/16x24	1"	3
53740	3/8x16	1"	3
53750	3/8x24	1"	3
53760	7/16x14	1"	3
53830	7/16x20	1"	3
53770	1/2x13	1"	3
53780	1/2x20	1"	3
53790	1/2x24	1"	3
53800	1/8x27 (PIPE)	1"	3
53810	1/4x18 (PIPE)	1"	3

These items are also available carded. See Price List Catalog for details.

### ADJUSTABLE & ROUND DIES: TIPS

#### Adjustable Dies:

These dies have a recessed adjusting screw so threads can be cut slightly under-size or oversize.

#### Round Dies:

Inexpensive round dies are 1" wide. They will thread rods up to 1/2" diameter.

## HI-CARBON TAPS - METRIC PLUG & TAPERED PIPE TAPS

### Type 780 -Metric Plug

- All popular sizes offered for foreign car, motorcycle, and machinery threading needs.



**TYPE 780 -METRIC PLUG**

Part No.	Size	Tap Drill Size	Number of Flutes	Qty. per/pack
83010	3x.50	40	3	3
83020	3x.60	3/32	3	3
83030	4x.70	1/8	4	3
83040	4x.75	1/8	4	3
83050	5x.80	11/64	4	3
83060	5x.90	20	4	3
83070	6x1.00	13/64	4	3
83080	7x1.00	15/64	4	3
84230	8x1.00	F	4	3
83090	8x1.25	17/64	4	3
83100	9x1.00	5/16	4	3
83110	9x1.25	5/16	4	3
56800	10x1.00	23/64	4	3
83130	10x1.25	S	4	3
83140	10x1.50	11/32	4	3
83150	11x1.50	3/8	4	3
84240	12x1.25	27/64	4	3
83160	12x1.50	13/32	4	3
83170	12x1.75	27/64	4	3
56810	14x1.25	33/64	4	1
84250	14x1.50	1/2	4	1
83190	14x2.00	15/32	4	1
83200	16x1.50	37/64	4	1
83210	16x2.00	35/64	4	1
56820	18x1.50	21/32	4	1
84260	18x2.00	5/8	4	1
83230	18x2.50	39/64	4	1

These items are also available carded. See Price List Catalog for details.

### Type 410 Pipe Taps

- Made of tough carbon steel to industry standards.

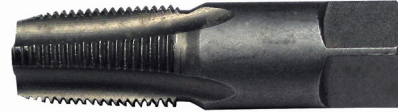

**TYPE 410 PIPE TAPS FRACTIONAL**

Part No.	Diameter	Tap Drill Size	Shank	Number of Flutes	Qty. per/pack
56910	1/8 x 27	11/32	5/16"	4	3
56920	1/4 x 18	7/16	7/16"	4	3
56930	3/8 x 18	37/64	1/2"	4	1
56940	1/2 x 14	23/32	1/2"	4	1
56950	3/4 x 14	59/64	5/8"	4	1
56960	1 x 11-1/2	1-5/32	13/16"	5	1
56970	1-1/4 x 11-1/2	1-1/2	1"	5	1
56980	1-1/2 x 11-1/2	1-47/64	1-1/4"	7	1
56990	2 x 11-1/2	2-7/32	1-3/8"	7	1



## Product Tips

### NEED A TAPPING LUBE ?

High Performance Ultra SP™ will do the job!

Found on page 104

## 14PC / 16PC HI-CARBON TAP & DIE SETS

**Type 724**

**Professional Quality**

- Made of high carbon tool steel
- Sharp, clean cutting edges, hardened, and tempered to cut smooth threads
- Sets are available in round and hexagon styles
  - Sets are packed in plastic cases
  - Select sizes of dies may be imported



### 14pc. Hi-Carbon Steel Fractional NC - with Hex Die Set

**Set contains:**

- Hi-Carbon steel plug taps and hex dies sizes:  
1/4-20, 5/16-18, 3/8-16, 7/16-14, 1/2-13, 1/8-27 NPT Pipe
  - T-Handle Tap Wrench: 3/16 to 1/2
  - Stock #HNC14pc
- Supplied in sturdy plastic case.*

**PART NO. 50090**

### 14pc. Hi-Carbon Steel Fractional NF - with Hex Die Set

**Set contains:**

- Hi-Carbon steel plug taps and hex dies sizes:  
1/4-28, 5/16-24, 3/8-24, 7/16-20, 1/2-20, 1/8-27 NPT Pipe
  - T-Handle Tap Wrench: 3/16 to 1/2
  - Stock #HNF14pc
- Supplied in sturdy plastic case.*

**PART NO. 50080**

### 14pc. Hi-Carbon Steel Fractional NC - with Round Die Set

**Set contains:**

- Hi-Carbon steel plug taps and round dies sizes:  
1/4-20, 5/16-18, 3/8-16, 7/16-14, 1/2-13, 1/8-27 NPT Pipe
  - T-Handle Tap Wrench: 3/16 to 1/2
  - Stock #RNC14pc
- Supplied in sturdy plastic case.*

**PART NO. 50030**

### 14 Piece Hi-Carbon Steel Fractional NF - with Round Die Set

**Set contains:**

- Hi-Carbon steel plug taps and round dies sizes:  
1/4-28, 5/16-24, 3/8-24, 7/16-20, 1/2-20, 1/8-27 NPT Pipe
  - T-Handle Tap Wrench: 3/16 to 1/2
- Supplied in sturdy plastic case.*

**PART NO. 50020**

### 16pc. Hi-Carbon Steel Metric - with Hex Die Set

**Set contains:**

- Hi-Carbon steel plug taps and hex dies sizes:  
4mm x 0.70, 5mm x 0.80, 6mm x 1.00, 8mm x 1.25,  
10mm x 1.25, 10mm x 1.50, 12mm x 1.50
- T-Handle Tap Wrench: 3/16 to 1/2
- Stock #HMM16pc

**PART NO. 50140**

### 16pc. Hi-Carbon Steel Fractional NC - with Hex Die Set

**Set contains:**

- Hi-Carbon steel plug taps and hex dies sizes:  
4-40, 6-32, 8-32, 10-24, 10-32, 12-24, 1/4-20
- T-Handle Tap Wrench: 0 to 1/4
- Stock #HEX16pc

**PART NO. 50100**

### 16 Piece Hi-Carbon Steel Fractional NC - with Round Die Set

**Set contains:**

- Hi-Carbon steel plug taps and round dies sizes:  
4-40, 6-32, 8-32, 10-24, 10-32, 12-24, 1/4-20
- T-Handle Tap Wrench: 0 to 1/4
- Stock #RND19pc

**PART NO. 50040**

## 24PC / 37PC HI-CARBON TAP & DIE SETS

### Type 724

#### Professional Quality

- Made of high carbon tool steel.
- Plug taps are furnished in all sets.
- Dies are available in round and hexagon styles.
- Sets are packed in plastic.
- Select sizes of dies may be imported



### 24pc. Hi-Carbon Steel Fractional Tap NC, NF - with Hex Die Set

#### Set contains:

- Hi-Carbon steel plug taps and hex dies sizes:  
1/4-20, 1/4-28, 5/16-18, 5/16-24, 3/8-16, 3/8-24,  
7/16-14, 7/16-20, 1/2-13, 1/2-20, 1/8-27 NPT Pipe
- T-Handle Tap Wrench: 3/16 to 1/2
- Economy die stock
- Stock #HEX24pc

*Supplied in sturdy plastic case.*

**PART NO. 50110**

### 24pc. Hi-Carbon Steel Fractional Tap NC, NF - with Round Die Set

#### Set contains:

- Hi-Carbon steel plug taps and round dies sizes:  
1/4-20, 1/4-28, 5/16-18, 5/16-24, 3/8-16, 3/8-24,  
7/16-14, 7/16-20, 1/2-13, 1/2-20, 1/8-27 NPT Pipe
- T-Handle Tap Wrench: 3/16 to 1/2
- Economy die stock
- Stock #RND24pc

*Supplied in sturdy plastic case.*

**PART NO. 50050**

### 37pc. Hi-Carbon Steel Machine Screw & Fractional Tap NC, NF - with Round Die Set

#### Set contains:

- Hi-Carbon steel plug taps and round dies sizes:  
4-40, 6-32, 8-32, 10-24, 10-32, 12-24, 1/4-20, 1/4-28  
5/16-18, 5/16-24, 3/8-16, 3/8-24, 7/16-14, 7/16-20  
1/2-13, 1/2-20, 1/8-27 NPT Pipe
- T-Handle Tap Wrench: 0 to 1/4 & 3/16 to 1/2
- Economy die stock
- Stock #RND37pc

*Supplied in sturdy plastic case.*

**PART NO. 50060**

### 37pc. Hi-Carbon Steel Master Metric - with Hex Die Set

#### Set contains:

- Hi-Carbon steel plug taps and hex dies sizes:  
3mm x 0.50, 3mm x 0.60, 4mm x 0.70, 4mm x 0.75,  
5mm x 0.80, 5mm x 0.90, 6mm x 1.00, 7mm x 1.00,  
8mm x 1.25, 9mm x 1.00, 9mm x 1.25, 10mm x 1.25,  
10mm x 1.50, 11mm x 1.50, 12mm x 1.50, 12mm x 1.75,  
1/8-27 NPT Pipe
- T-Handle Tap Wrench: 0 to 1/4 & 3/16 to 1/2
- Stock #HMM37pc

*Supplied in sturdy plastic case.*

**PART NO. 50150**

### 37pc. Hi-Carbon Steel Machine Screw & Fractional NC, NF - with Hex Die Set

#### Set contains:

- Hi-Carbon steel plug taps and hex dies sizes:  
4-40, 6-32, 8-32, 10-24, 10-32, 12-24, 1/4-20, 1/4-28  
5/16-18, 5/16-24, 3/8-16, 3/8-24, 7/16-14, 7/16-20  
1/2-13, 1/2-20, 1/8-27 NPT Pipe
- T-Handle Tap Wrench: 0 to 1/4 & 3/16 to 1/2
- Stock #HEX37pc

*Supplied in sturdy plastic case.*

**PART NO. 50120**

## 40pc HI-CARBON MACHINE SCREW / FRACTIONAL

### Type 724

#### Professional Quality

- Taps and Dies made of high carbon steel.
- Plug taps are furnished in all sets in sizes to fill most requirements.
- Dies are available in round and hex styles.
- Sets are packed in durable plastic cases.
- Select sizes of dies may be imported.



Hi-Carbon Taps & Die Sets Machine Screw / Fractional

### 40pc. Hi-Carbon Steel Machine Screw Fractional Tap NC, NF - with Round Die Set

#### Set contains:

- Hi-Carbon steel plug taps and round dies sizes:  
4-40 , 6-32, 8-32, 10-24, 10-32, 12-24, 1/4-20, 1/4-28,  
5/16-18, 5/16-24, 3/8-16, 3/8-24, 7/16-14, 7/16-20,  
1/2-13, 1/2-20, 1/8-27 NPT Pipe
  - T-Handle Tap Wrench: 0 to 1/4 & 3/16 to 1/2
  - Tap & Reamer Wrench: #4 to 1/2
  - Adjustable Die Stock, Screw Driver, Screw Pitch Gauge
  - Stock #RND40pc
- Supplied in sturdy plastic case.*

**PART NO. 50070**

### 40pc. Hi-Carbon Steel Machine Screw/Fractional NC, NF - with Hex Die Set

#### Set contains:

- Hi-Carbon steel plug taps and hex dies sizes:  
4-40 , 6-32, 8-32, 10-24, 10-32, 12-24, 1/4-20, 1/4-28,  
5/16-18, 5/16-24, 3/8-16, 3/8-24, 7/16-14, 7/16-20,  
1/2-13, 1/2-20, 1/8-27 NPT Pipe
  - T-Handle Tap Wrench: 0 to 1/4 & 1/4 to 1/2
  - Tap & Reamer Wrench: 0 to 1/2
  - Adjustable Die Stock, Screw Driver, Screw Pitch Gauge
  - Stock #HEX40pc
- Supplied in sturdy plastic case.*

**PART NO. 50130**

## TAP & REAMER WRENCHES

- Accessories for every threading job, economy, and professional type.
- Rugged construction.
- Tap wrench jaws heat treated and hardened for long life.
- Offered in display packages as indicated.

### Type 725

#### Tap & Reamer Wrench - Professional Quality

- Hardened steel jaws. Adjusts easily by turning handles



Part No.	For Tap Sizes	Package Type	Qty. per/pack
50350	1/4-3/4	Bulk	1
50360	1/2-1-1/8	Bulk	1
50347	4-1/2	Carded	1

### Type 726

#### Tap & Reamer Wrench - Economy

- For taps up to 1/2"
- Chrome finished, knurled handles with black center

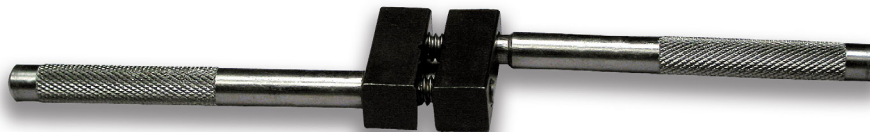

Part No.	For Tap Sizes	Package Type	Qty. per/pack
50337	Up to 1/2	Carded	1

### Type 727R

#### Ratcheting T-Handle Tap Wrenches



- Three position gear box for quick efficient ratcheting action
- Designed for use with taps, reamers, screw extractors and other tools with a square shank.
- Chrome plated for long life and rust resistance

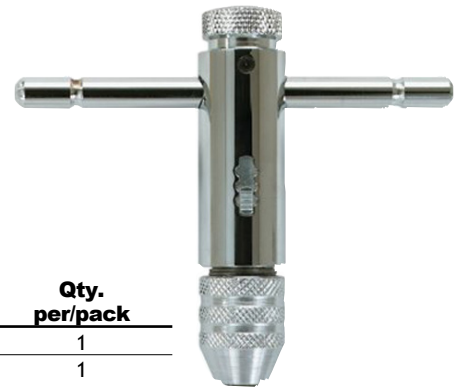

Part No.	For Tap Sizes	Package Type	Qty. per/pack
50190	0 - 1/4" (3mm - 6mm)	Bulk	1
50200	1/4 - 1/2" (6mm - 12mm)	Bulk	1

### Type 727

#### T-Handle Tap Wrenches

- Sliding T-handle with spring tension to hold taps in place, self equalizing jaws.
- No. 50320 has removable handle and 3/8" female square drive for extensions, ratchet, and power drive.

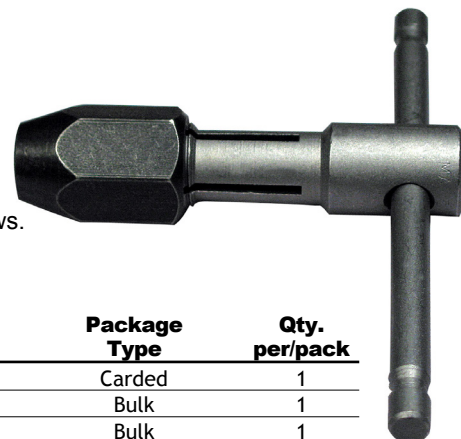

Part No.	For Tap Sizes	Package Type	Qty. per/pack
50307	0-1/4	Carded	1
50310	3/16-1/2	Bulk	1
50320	3/16-1/2	Bulk	1



## DIE STOCKS AND SCREW PITCH GAUGES

- Accessories for every threading job, economy and professional type.
- Rugged construction. Offered in display packages as indicated.



**Type 728**  
**Die Stock**  
- Economy Solid

- Designed to hold either 1"- Round or Hex dies.

### TYPE 728 DIE STOCK

Part No.	Across Flats	Package Type	Qty. per/pack
50377	1" round or hex	Carded	1



**Type 729**  
**Die Stock**  
- Professional Quality

Numbers 50387 and 50390 have 3-jaw self centering adjustable guides to assure straight threads and easy starting.

- Number 50400 is a sturdy cast hex die stock with chromed steel handles.

### TYPE 729 DIE STOCK

Part No.	Across Flats	Package Type	Qty. per/pack
50390	1-1/2" Round, 1-7/16 Hex	Bulk	1
50400	1-7/8" Hex	Bulk	1
50387	1" Round or Hex	Carded	1

### Type 730

#### - Screw Pitch Gauges

- Made with flat thread forms on top of each blade.
- Gives screw pitches on V-threads, U.S. and Metric gauges available.

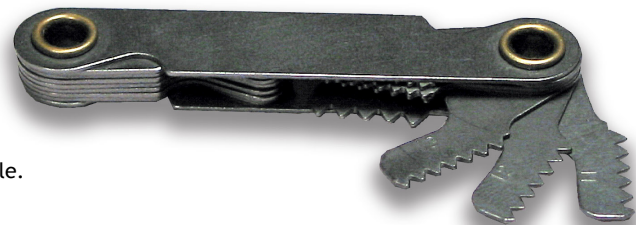

### TYPE 730 SCREW PITCH GAUGES

Part No.	For Tap Sizes	Package Type	Qty. per/pack
50417	US 12 - 40 U.S.	Carded	1
50427	METRIC 0.5 - 1.75 mm, #27 and #28	Carded	1

# Technical Reference

## STANDARD CUTTING TAPS

### Machine Screw Sizes

Tap	Tap Drill	Decimal Equiv. of Tap Drill	Theoretical % of Thread	Prob-able Oversize (Mean)	Prob-able Hole Size	Percentage of Thread
0-80	56	.0465	83	.0015	.0480	74
	5/64	.0469	81	.0015	.0484	71
1-64	54	.0550	89	.0015	.0565	81
1-72	53	.0595	75	.0015	.0610	67
2-56	51	.0670	82	.0017	.0687	74
	50	.0700	69	.0017	.0717	62
2-64	50	.0700	79	.0017	.0717	70
3-48	48	.0760	85	.0019	.0779	78
	5/64	.0781	77	.0019	.0800	70
	47	.0785	76	.0019	.0804	69
	46	.0810	67	.0019	.0829	60
3-56	46	.0810	78	.0019	.0829	69
	45	.0820	73	.0019	.0839	65
4-40	44	.0860	80	.0020	.0880	74
	43	.0890	71	.0020	.0910	65
4-48	42	.0935	68	.0020	.0955	61
	3/32	.0938	68	.0020	.0958	60
5-40	40	.0980	83	.0023	.1003	76
	39	.0995	79	.0023	.1018	71
	38	.1015	72	.0023	.1038	65
5-44	38	.1015	79	.0023	.1038	72
	37	.1040	71	.0023	.1063	63
6-32	37	.1040	84	.0023	.1063	78
	36	.1065	78	.0026	.1091	71
	7/64	.1094	70	.0026	.1120	64
	35	.1100	69	.0026	.1126	63
	34	.1110	67	.0026	.1136	60
6-40	34	.1110	83	.0026	.1136	75
	33	.1130	77	.0026	.1156	69
	32	.1160	68	.0026	.1186	60
8-32	29	.1360	69	.0029	.1389	62
8-36	29	.1360	78	.0029	.1389	70
10-24	27	.1440	85	.0032	.1472	79
	26	.1470	79	.0032	.1502	74
	25	.1495	75	.0032	.1527	69
	24	.1520	70	.0032	.1552	64
	23	.1540	67	.0032	.1572	61
	22	.1570	61	.0032	.1602	55
10-32	3/32	.1563	83	.0032	.1595	75
	22	.1570	81	.0032	.1602	73
	21	.1590	76	.0032	.1622	68
	20	.1610	71	.0032	.1642	64
12-24	17/64	.1719	82	.0035	.1754	75
	17	.1730	79	.0035	.1765	73
	16	.1770	72	.0035	.1805	66
	15	.1800	67	.0035	.1835	60
12-28	16	.1770	84	.0035	.1805	77
	15	.1800	78	.0035	.1835	70
	14	.1820	73	.0035	.1855	66

These tables show both the theoretical percentage of thread represented by the drill size and the percentage that would normally be obtained in drilling.

### Fractional Sizes

Tap	Tap Drill	Decimal Equiv. of Tap Drill	Theoretical % of Thread	Prob-able Oversize (Mean)	Prob-able Hole Size	Percentage of Thread
1/4-20	9	.1960	83	.0038	.1998	77
	8	.1990	79	.0038	.2028	73
	7	.2010	75	.0038	.2048	70
	13/64	.2031	72	.0038	.2069	66
	6	.2040	71	.0038	.2078	65
	5	.2055	69	.0038	.2093	63
	4	.2090	63	.0038	.2128	57
1/4-28	3	.2130	80	.0038	.2168	72
5/16-18	F	.2570	77	.0038	.2608	72
	G	.2610	71	.0041	.2651	66
5/16-24	H	.2660	86	.0041	.2701	78
	I	.2720	75	.0041	.2761	67
3/8-16	3/16	.3125	77	.0044	.3169	72
	O	.3160	73	.0044	.3204	68
3/8-24	27/64	.3281	87	.0044	.3325	79
	Q	.3320	79	.0044	.3364	71
7/16-14	T	.3580	86	.0046	.3626	81
	23/64	.3594	84	.0046	.3640	79
	U	.3680	75	.0046	.3726	70
	3/8	.3750	67	.0046	.3796	62
	V	.3770	65	.0046	.3816	60
7/16-20	W	.3860	79	.0046	.3906	72
	25/64	.3906	72	.0046	.3952	65
1/2-13	27/64	.4219	78	.0047	.4266	73
1/2-20	29/64	.4531	72	.0047	.4578	65
9/16-12	15/32	.4688	87	.0048	.4736	82
	31/64	.4844	72	.0048	.4892	68
9/16-18	1/2	.5000	87	.0048	.5048	80
5/8-11	17/32	.5313	79	.0049	.5362	75
	35/64	.5469	66	.0049	.5518	62
5/8-18	3/16	.5625	87	.0049	.5674	80
3/4-10	41/64	.6406	84	.0050	.6456	80
	21/32	.6563	72	.0050	.6613	68
3/4-16	11/16	.6875	77	.0050	.6925	71
7/8-9	49/64	.7656	76	.0052	.7708	72
	29/32	.7812	65	.0052	.7864	61
7/8-14	81/64	.7969	84	.0052	.8021	79
	13/16	.8125	67	.0052	.8177	62
1"-8	85/64	.8594	87	.0059	.8653	83
	7/8	.8750	77	.0059	.8809	73
	85/64	.8906	67	.0059	.8965	64
1"-12	23/32	.9063	87	.0060	.9122	81
	89/64	.9219	72	.0060	.9279	67
1"-14	89/64	.9219	84	.0060	.9279	78
	15/16	.9375	67	.0060	.9435	61
1 1/8-7	31/32	.9688	84	.0062	.9750	81
	83/64	.9844	76	.0067	.9911	72
	1"	1.0000	67	.0070	1.0070	64
1 1/8-12	1 1/32	1.0313	87	.0071	1.0384	80
	1 3/64	1.0469	72	.0072	1.0541	66
1 1/4-7	1 3/32	1.0938	84			
	1 7/64	1.1094	76			
	1 1/8	1.1250	67			
1 1/4-12	1 5/32	1.1563	87			
	1 11/64	1.1719	72			
1 3/8-6	1 3/16	1.1875	87			
	1 13/64	1.2031	79			
	1 7/32	1.2188	72			
	1 15/64	1.2344	65			
1 3/8-12	1 9/32	1.2813	87			
	1 19/64	1.2969	72			
1 1/2-6	1 1/16	1.3125	87			
	1 21/64	1.3281	79			
	1 11/32	1.3438	72			
	1 23/64	1.3594	65			
1 1/2-12	1 13/32	1.4063	87			
	1 27/64	1.4219	72			

Reaming Recommended

## Metric Cutting Taps

Metric Tap Size	Basic Major Dia. (Ins.)	Tap Drill Size	Decimal Equiv. of Tap Drill (Ins.)	Theoretical Percent of Thread	Probable Mean Over-Size (Ins.)	Probable Hole Size (Ins.)	Probable Percent of Thread
M1.6 x 0.35	.0630	1.25 mm	.0492	77	.0015	.0507	69
M1.8 x 0.35	.0709	1.45 mm	.0571	77	.0015	.0586	69
M2 x 0.4	.0787	1/16" 1.60 mm #52	.0625 .0630 .0635	79 77 74	.0015 .0017 .0017	.0640 .0647 .0652	72 69 66
M2.2 x 0.45	.0866	1.75 mm	.0689	77	.0017	.0706	70
M2.5 x 0.45	.0984	2.05 mm #46 #45	.0807 .0810 .0820	77 76 71	.0019 .0019 .0019	.0826 .0829 .0839	69 67 63
M3 x 0.5	.1181	#40 2.5 mm #39	.0980 .0984 .0995	79 77 73	.0023 .0023 .0023	.1003 .1007 .1018	70 68 64
M3.5 x 0.6	.1378	#33 2.9 mm #32	.1130 .1142 .1160	81 77 71	.0026 .0026 .0026	.1156 .1168 .1186	72 68 63
M4 x 0.7	.1575	*3.25 mm #30 3.3 mm	.1280 .1285 .1299	82 81 77	.0029 .0029 .0029	.1309 .1314 .1328	74 73 69
M4.5 x 0.75	.1772	3.7 mm #26 *3.75 mm #25	.1457 .1470 .1476 .1495	82 79 77 72	.0032 .0032 .0032 .0032	.1489 .1502 .1508 .1527	74 70 69 64
M5 x 0.8	.1968	4.2 mm #19	.1654 .1660	77 75	.0032 .0032	.1686 .1692	69 68
M6 x 1	.2362	#10 #9 5 mm #8	.1935 .1960 .1968 .1990	84 79 77 73	.0038 .0038 .0038 .0038	.1973 .1998 .2006 .2028	76 71 70 65
M7 x 1	.2756	"A" 1 1/64" 6 mm "B"	.2340 .2344 .2362 .2380	81 81 77 74	.0038 .0038 .0038 .0038	.2378 .2382 .2400 .2418	74 73 70 66
M8 x 1.25	.3150	6.7 mm 1 7/64" *6.75 mm "H" 6.8 mm	.2638 .2656 .2657 .2660 .2677	80 77 77 77 74	.0041 .0041 .0041 .0041 .0041	.2679 .2697 .2698 .2701 .2718	74 71 71 70 68
M8 x 1	.3150	7 mm "J"	.2756 .2770	77 74	.0041 .0041	.2797 .2811	69 66
M10 x 1.5	.3937	8.4 mm "Q" 8.5 mm	.3307 .3320 .3346	82 80 77	.0044 .0044 .0044	.3351 .3364 .3390	76 75 71
M10 x 1.25	.3937	8.7 mm 1 1/32" *8.75 mm	.3425 .3438 .3445	80 78 77	.0046 .0046 .0046	.3471 .3483 .3491	73 71 70
M12 x 1.75	.4724	10.2 mm "Y" 1 1/32"	.4016 .4040 .4062	79 76 74	.0047 .0047 .0047	.4063 .4087 .4109	74 71 69

Metric Tap Size	Basic Major Dia. (Ins.)	Tap Drill Size	Decimal Equiv. of Tap Drill (Ins.)	Theoretical Percent of Thread	Probable Mean Over-Size (Ins.)	Probable Hole Size (Ins.)	Probable Percent of Thread
M12 x 1.25	.4724	2 1/64" 10.8 mm	.4219 .4252	79 74	.0047 .0047	.4266 .4299	72 66
M14 x 2	.5512	1 1/32" 12 mm	.4688 .4724	81 77	.0048 .0048	.4736 .4772	76 72
M14 x 1.5	.5512	12.5 mm	.4921	77	.0048	.4969	71
M16 x 2	.6299	3 5/64" 14 mm	.5469 .5512	81 77	.0049 .0049	.5518 .5561	76 72
M16 x 1.5	.6299	14.5 mm	.5709	77	.0049	.5758	71
M18 x 2.5	.7087	3 9/64" 15.5 mm	.6094 .6102	78 77	.0050 .0050	.6144 .6152	74 73
M18 x 1.5	.7087	4 1/64" 16.5 mm 2 1/32"	.6406 .6496 .6562	89 77 68	.0050 .0050 .0050	.6456 .6546 .6612	82 70 62
M20 x 2.5	.7874	1 1/16" 17.5 mm	.6875 .6890	78 77	.0050 .0052	.6925 .6942	74 73
M20 x 1.5	.7874	18.5 mm	.7283	77	.0052	.7335	70
M22 x 2.5	.8661	4 9/64" 19.5 mm	.7656 .7677	79 77	.0052 .0052	.7708 .7729	75 73
M22 x 1.5	.8661	20.5 mm	.8071	77	.0052	.8123	70
M24 x 3	.9449	21 mm 5 3/64"	.8268 .8281	77 76	.0059 .0059	.8327 .8340	73 72
M24 x 2	.9449	22 mm	.8661	77	.0059	.8720	71
M27 x 3	1.0630	1 5/16" 24 mm	.9375 .9449	82 77	.0060 .0062	.9435 .9511	78 73
M27 x 2	1.0630	25 mm 6 3/64"	.9843 .9844	77 77	.0070 .0070	.9913 .9914	70 70
M30 x 3.5	1.1811	26.5 mm 1 3/4"	1.0433 1.0469	77 75			
M30 x 2	1.1811	28 mm 1 7/64"	1.1024 1.1094	77 70			
M33 x 3.5	1.2992	1 1/32" 29.5 mm 1 1/4"	1.1562 1.1614 1.1719	80 77 71			
M33 x 2	1.2992	1 1/32" 31 mm	1.2188 1.2205	79 77			
M36 x 4	1.4173	1 1/4" 32 mm	1.2500 1.2598	82 77			
M36 x 3	1.4173	1 9/64" 33 mm	1.2969 1.2992	78 77			
M39 x 4	1.5354	1 3/8" 35 mm	1.3750 1.3780	78 77			
M39 x 3	1.5354	36 mm 1 3/4"	1.4173 1.4219	77 74			

REAMING RECOMMENDED

Note: Sizes with an asterisk (\*) are not standard drills.

### METRIC THREAD FORMULAE

$$\text{Basic major dia. (mm)} - \frac{\% \text{ thread} \times \text{mm pitch}}{76.980} = \text{Drilled hole size (mm)}$$

$$\frac{76.980}{\text{mm pitch}} \times [\text{Basic major dia. (mm)} - \text{Drilled hole size (mm)}] = \% \text{ of thread}$$

## Taps

Problems encountered in tapping are often the fault of the tapping machine, tap holding devices and conditions of the hole to be tapped. The tapping machine should be checked for spindle, fixture and work alignment; for slipping belts, wear and power. The tap holding device should be checked as to correct type, for wear and alignment with the hole. The drilled hole should be checked for diameter and trueness in round and axis to assure correct percentage of thread engagement. Blind holes must have sufficient chip room at the bottom.

### General Suggestions

1. If holes are undersize or oversize check against the setup instructions. Check the tap for correct pitch diameter limit for desired class of thread, and the drill for correct size.
2. If the tap is producing rough thread it generally means that the tap is pushing or tearing the metal instead of cutting it. The tap may be dull, have galled threads or may be running at too slow a speed. If none of these, increase the hook angle of the cutting face.
3. If the tap is loading (metal clinging to the tap) or galling, check the lubrication. Here, too, the tap may be dull, or it may be producing too high a percentage of thread. Shift to a surface-treated tap.
4. If tap breakage is encountered the tap may be cutting too high a percentage of thread, be insufficiently lubricated or have too little clearance for chips at the bottom of the blind hole. If none of these conditions exist, increase the speed, except in hard or tough materials. In these materials, lower the speed.

Trouble	Cause
Tap Breakage	<ol style="list-style-type: none"> <li>1. Wrong type of tap.</li> <li>2. Dull tap.</li> <li>3. Tap incorrectly ground.</li> <li>4. Tap drill too small.</li> <li>5. Drilled hole too shallow.</li> <li>6. Misalignment of tap and hole.</li> <li>7. Wrong machine.</li> <li>8. Incorrect fixture or holding device.</li> <li>9. Work hardened material/</li> <li>10. Lack of lubricant, or use of wrong type.</li> </ol>
Tap Failure on Reversal	<ol style="list-style-type: none"> <li>1. Tap cutting too tightly. Cutting face angle should be increased.</li> <li>2. Tap galling. Face angle on back of land should be increased.</li> <li>3. Chips wedged between flutes. (See the following)</li> </ol>
Chips Clogging Flutes	<ol style="list-style-type: none"> <li>1. Wrong type of tap.</li> <li>2. Insufficient chamfer.</li> <li>3. Incorrect cutting face angle.</li> <li>4. Rough Flutes.</li> <li>5. Flutes improperly reground.</li> <li>6. Lack of lubrication, or use of wrong type.</li> </ol>
Stripped or Chipped Tap Threads	<ol style="list-style-type: none"> <li>1. Misalignment.</li> <li>2. Careless handling.</li> <li>3. Dull Tap</li> <li>4. Tap too hard.</li> <li>5. Wrong application of surface treated taps.</li> <li>6. Improper sharpening of tap.</li> </ol>
Torn Threads in Tapped Part	<ol style="list-style-type: none"> <li>1. Incorrect cutting face angle (usually too small).</li> <li>2. Tap drill too small.</li> <li>3. Chips clogging flutes.</li> <li>4. Broken threads on taps.</li> <li>5. Improper resharpening of tap.</li> <li>6. Lack of lubricant, or use of wrong type.</li> </ol>
Tap Sticking or Binding	<ol style="list-style-type: none"> <li>1. Tap drill too small.</li> <li>2. Tap lands too wide.</li> <li>3. Incorrect cutting face angle.</li> <li>4. Lack of lubricant, or use of wrong type.</li> <li>5. Surface treatment (lubricant) required.</li> </ol>
Excessive Tap Wear	<ol style="list-style-type: none"> <li>1. Material is abrasive, or inclusions present. Surface treated tap required.</li> <li>2. Misalignment.</li> </ol>
Cutting Face Breakdown	<ol style="list-style-type: none"> <li>1. Incorrect cutting face angle.</li> <li>2. Surface treatment required.</li> </ol>
Overheating of Tap	<ol style="list-style-type: none"> <li>1. Excessive land width.</li> <li>2. Lack of lubricant, or use of wrong type.</li> <li>3. Dull tap.</li> <li>4. Excessive flank contact, pitch diameter relief required.</li> <li>5. Excessive tapping speeds.</li> </ol>
Poor Finish on Thread in Tapped Part	<ol style="list-style-type: none"> <li>1. Pitch diameter relief required.</li> <li>2. Incorrect cutting face angle, usually too small.</li> <li>3. Tap drill too small.</li> <li>4. Insufficient number of chamfered threads.</li> <li>5. Dull tap.</li> <li>6. Lack of lubricant, or use of wrong type.</li> </ol>
Excessive Frictional Drag and Power Requirement	<ol style="list-style-type: none"> <li>1. Pitch diameter relief required.</li> <li>2. Point size on tap too small.</li> <li>3. Dull tap.</li> <li>4. Incorrect cutting face angle.</li> <li>5. Incorrect tapping speed.</li> <li>6. Lack of lubricant, or use of wrong type.</li> <li>7. Incorrect or inadequate equipment.</li> <li>8. Misalignment.</li> </ol>

## Tap Limits, Product Limits

## CLASS OF THREAD

We sometimes receive requests for a Class 3B (or other class) tap. Many times the customer will ask for a tap to produce a "Class 3B Fit". Ordering taps by these specifications is incorrect and often impractical. The following information is presented to clarify the difference between the terms Class of Thread, Tap Limits and Product Limits to make ordering taps easier and aid the customer in obtaining the tap best suited for their requirements.

### Class of Thread

Class of Thread refers simply to the tolerances that control the closeness of fit between two threaded mating parts. This term should be used only in reference to a threaded assembly, as, for example, a screw and nut.

### Product Limits

Product Limits refer to the limits and tolerances of the internal or female thread. The degree of tolerance is expressed by the terms Class 2, 2B, 3 and 3B. Product limits refer to the various limits and tolerances applying to nuts or internal threads and are identified by the terms Class 2, 2B, 3 or 3B.

### Tap Limits

Tap Limits refer to the various sizes of taps manufactured to permit selection of a tap which will produce an internal thread within the desired product limit. Tap limits are designated as L-1, H-1, H-2, H-3, etc.

In the chart on this page we have illustrated the difference between tap and product limit, using a 1/4-20 tapped hole as the example.

Although ground thread taps are produced to precision tolerances under closely controlled manufacturing processes and are guaranteed for accuracy of individual elements, there is always the possibility of the presence of unknown factors which can be detrimental to good tap performance. The tap manufacturer, therefore, is not able to guarantee the size of the tapped hole.

To summarize, the following points should be remembered:

1. A tap cannot produce a Class of Thread. It can produce a tapped hole within specific product limits.
2. Since it is used only in tapping a hole, or producing an internal thread, a tap has no control over the fitting properties of the mating external thread.
3. To product what is commonly referred to as a "Class of Thread," both the external and internal threads must be within their respective product limits. Only when both members of a threaded assembly fall within the desired class limits can the proper fit be assured.
4. The acceptability of any class of threaded hole is determined only by an accurate "Go" or "Hi" thread plug gage of the corresponding class. Similarly, the acceptability of a male part with an external thread is also determined by a corresponding "Go" or "Lo" thread ring gage.
5. When ordering taps, specify either the tap limit or the class of thread that identifies the limit of the tapped hole.
6. In special applications, supply as much information as possible. The more information our engineers have to work with, the better they can recommend a tap to do the job properly with least expense.
7. Remember, it is not always the most expensive tap which will do the job best. Our files contain many examples of special jobs which were solved with inexpensive standard taps.

### 1/4 - 20 Tapped Hole

Class 2 Limit GH-3 Tap

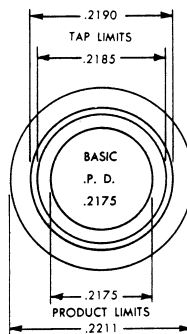

Class 2B Limit GH-5 Tap

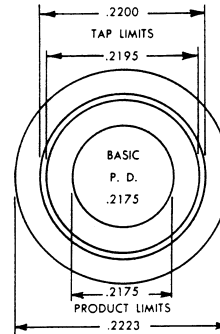

Class 3 Limit GH-2 Tap

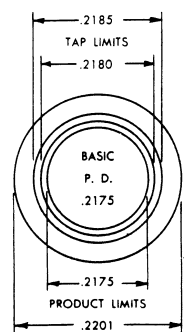

Class 3B Limit GH-3 Tap

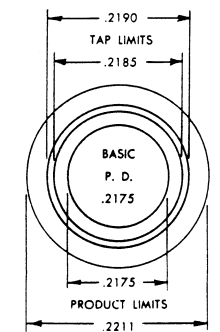

## Thread Constants for Various Percentages

### TAPS

**EXAMPLE:** To find the hole size for obtaining 75% of thread in a ¼-20 tapped hole, follow first column to 20 threads, then across to 75% of thread. This figure (.0485) when subtracted from the .250 diameter leaves .2015, which is the required diameter of the hole for a ¼-20 thread.

### Relation of Tap Pitch Diameter to Basic Pitch Diameter

### Relation of Tap Pitch Diameter To Basic Pitch Diameter

American tap manufacturers use a series of tap pitch diameter limits. These limits feature a .0005" tolerance in tap sizes #0 through 1", and a .001" or greater tolerance in tap sizes above 1" through 1½" diameter, inclusive. The chart shows the relationship between tap pitch diameter limits and basic (nominal) pitch diameter.

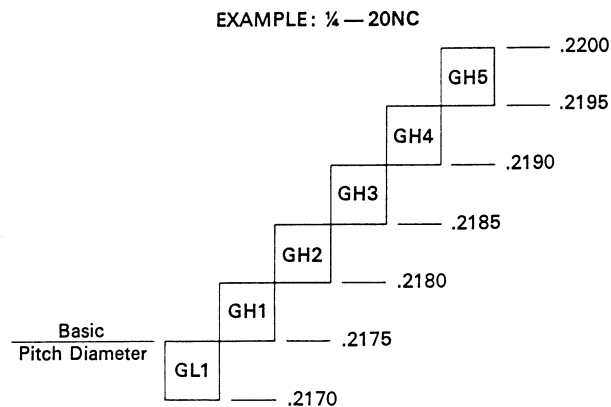

### FORMULA FOR OBTAINING TAP DRILL SIZES

(Select nearest commercial stock drill)

$$\left( \begin{array}{c} \text{Outside Diam.} \\ \text{of Thread} \end{array} \right) - \left( \frac{.01299 \times \text{Amount of percentage of full thread}}{\text{Number of threads per inch}} \right) = \text{Drilled Hole Size}$$

$$\left( \begin{array}{c} \text{No. of Threads} \\ \text{per inch} \end{array} \right) \times \left( \frac{\text{Outside Diam. of thread} - \text{Selected Drill Diam.}}{.01299} \right) = \text{Percentage of Full Thread}$$

Figures in table show amount to subtract from O.D. of screw to obtain specific percentages of thread.

Threads per Inch	Double Depth	60% Thread	65% Thread	70% Thread	75% Thread	80% Thread	85% Thread
6	.21651	.1300	.1408	.1517	.1625	.1733	.1842
7	.18558	.1114	.1207	.1300	.1393	.1486	.1579
8	.16238	.0975	.1056	.1138	.1219	.1300	.1381
9	.14434	.0866	.0939	.1011	.1083	.1156	.1228
10	.12990	.0779	.0844	.0909	.0974	.1039	.1105
11	.11809	.0708	.0767	.0826	.0885	.0944	.1005
12	.10825	.0649	.0702	.0755	.0808	.0861	.0921
13	.09992	.0599	.0649	.0699	.0749	.0799	.0850
14	.09278	.0556	.0602	.0648	.0694	.0740	.0789
16	.08119	.0486	.0526	.0566	.0606	.0646	.0691
18	.07217	.0431	.0466	.0501	.0536	.0571	.0614
20	.06495	.0389	.0421	.0453	.0485	.0517	.0553
24	.05412	.0326	.0354	.0382	.0410	.0438	.0460
27	.04811	.0288	.0312	.0336	.0360	.0384	.0409
28	.04639	.0276	.0298	.0324	.0347	.0370	.0395
30	.04330	.0260	.0282	.0304	.0326	.0348	.0368
32	.04059	.0243	.0263	.0283	.0303	.0323	.0345
36	.03608	.0216	.0234	.0252	.0270	.0288	.0307
40	.03247	.0194	.0210	.0226	.0242	.0258	.0276
44	.02952	.0177	.0192	.0207	.0222	.0237	.0251
48	.02706	.0161	.0174	.0187	.0200	.0213	.0230
56	.02319	.0138	.0149	.0160	.0171	.0182	.0197
64	.02029	.0121	.0131	.0141	.0151	.0161	.0173
72	.01804	.0107	.0115	.0123	.0131	.0139	.0153
80	.01623	.0097	.0105	.0113	.0121	.0129	.0138