

Founded in 1972

The fastest-growing vehicle lighting manufacturer in the U.S., Optronics International attributes its success to delivering better value, better options and better lighting to its customers. Optronics International is a premier worldwide manufacturer of industrial and commercial vehicle safety lighting products. Optronics specializes in interior and exterior LED and incandescent lighting for the HD, trailer, RV, marine, and transit vehicle markets.

ISO Certified

Optronics is headquartered in Tulsa, Oklahoma, with an ISO/TS 16949:2009 certified manufacturing facility in Annan District, Tainan, Taiwan, and additional manufacturing capabilities in its ISO 9001:2008 certified facility in Muskogee, Oklahoma. The company has an ISO 9001:2008 certified distribution facility in Goshen, Indiana, as well as distribution through its location in Ontario, Canada.

Lifetime LED Warranty

ALL Optronics LED lighting is now covered by a one-diode lifetime warranty that replaces the lamp if even one diode fails.



Muskogee, OK



Goshen, IN



Tainan City, Taiwan



CONTENTS

All Optronics products conform to DOT/SAE/FMVSS/CMVSS
108 standards where applicable when applied according
to federal lighting requirements

LED TRUCK & TRAILER LIGHTING	2 - 168
Headlamps	2
FUSION™ Stop/Turn/Tail/Back-Up Lamps.....	4
Sealed Stop/Turn/Tail Lights & Parking/Turn Signals	8
Combination Tail Lights & Kits	37
Towing Lights.....	59
DOT Compliant Back-Up Lights	60
Warning Lights	70
Millennium® Series.....	73
Sealed Marker/Clearance Lights	80
Surface Mount Marker/Clearance Lights.....	110
Identification Light Bars	127
License Plate Lights	132
Utility Lights	138
Interior & Utility Lights	146
Work & Utility Lights	158
INCANDESCENT TRUCK & TRAILER LIGHTING	169 - 233
Sealed Stop/Turn/Tail Lights & Parking/Turn Signals	169
Combination Tail Lights & Kits	173
DOT Compliant Back-Up Lights	187
Millennium Series® Marker/Clearance Lights	189
Sealed Marker/Clearance Lights	191
Surface Mount Marker/Clearance Lights.....	200
Identification Light Bars	214
License & Utility Lights	217
Utility & Interior Lights	227
Work & Ag Lights	231
Halogen Lights.....	232
RV LIGHTS & ACCESSORIES	234 - 262
ACCESSORIES - CONSPICUITY, MOUNTING, WIRING	263 - 288
FMVSS LIGHTING REQUIREMENTS	289 - 295
INDEX	296 - 305

Optronics International

OKLAHOMA: 401 South 41st Street East, Muskogee OK 74403
toll free: 800-364-5483 • phone: 918-683-9514 • fax: 918-683-9517

INDIANA: 3535 Corrie Dr, Goshen, IN 46526
toll free: 800-826-5483 • phone: 574-389-0040 • fax: 574-389-0041
website: www.optronicsinc.com • email: sales@optronicsinc.com

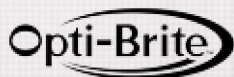

HLL88LB



HLL89HB



HLL88/89 SERIES DOT Compliant High and Low Beam Sealed LED Headlamps

- Replace standard 4" x 6" sealed beam halogen and HID headlamps
- Light output whiter than incandescent for greater visibility
- Long lasting, energy efficient – diodes last up to 50 times longer than incandescent, draw less than 1 amp
- Dual power: use with 12VDC or 24VDC systems
- Hard wired with standard H4 3-blade connector; 16 gauge, 7-inch leads
- Die cast aluminum construction with powder coat finish resists corrosion
- Tough polycarbonate lens with protective coating

BULK P/N	POLYPACK P/N	DESCRIPTION	QTY
LOW BEAM HEADLAMP - 8 DIODES			
HLL88LB	HLL88LBP	12-24VDC Low beam	1
HIGH BEAM HEADLAMP - 8 DIODES			
HLL89HB	HLL89HBP	12-24VDC High beam	1

HLL88LB: 12.8VDC - 23.7W / 28VDC - 23.7W

HLL89HB: 12.8VDC - 23.7W / 28VDC - 23.7W

IP67 rating: protected from dust and capable of withstanding water immersion, offering increased reliability and service life

FMVSS	HL
MATERIALS	Polycarbonate lens, aluminum housing
VOLT/AMP	12.8VDC - 0.85A
WT/DIMS	1.14 lbs. / 6.563" x 4.188" x 3.313"
WARRANTY	Lifetime LED Warranty

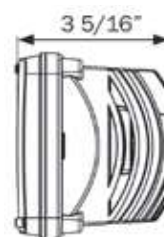
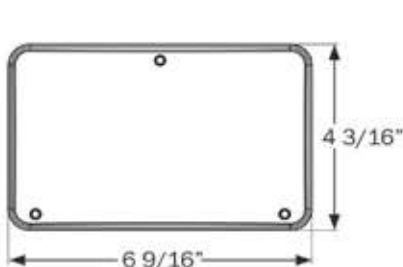

HLL90 SERIES DOT Compliant High/Low Beam Sealed LED Headlamp



- Replace standard 7" sealed beam halogen and HID headlamps
- Light output whiter than incandescent for greater visibility
- Long lasting, energy efficient – diodes last up to 50 times longer than incandescent, draw less than 1 amp
- Dual power: use with 12VDC or 24VDC systems
- Hard wired with standard H4 3-blade connector; 16 gauge, 7-inch leads
- Die cast aluminum construction with powder coat finish resists corrosion
- Tough polycarbonate lens with protective coating

LED DOT COMPLIANT HEADLAMPS



HLL90HLB



BULK P/N	POLYPACK P/N	DESCRIPTION	QTY
HIGH/LOW BEAM HEADLAMP - 16 DIODES			
HLL90HLB	HLL90HLBP	12-24VDC High/low beam	1

High Beam: 12.8VDC - 23.68W / 28VDC - 22.4W
Low Beam: 12.8VDC - 23.04W / 28VDC - 22.4W

IP67 rating: protected from dust and capable of withstanding water immersion, offering increased reliability and service life

FMVSS	HL
MATERIALS	Polycarbonate lens, aluminum housing
VOLT/AMP	12.8VDC - High Beam 1.85A / Low Beam 1.80A
WT/DIMS	2.05 lbs. / 7" x 7" x 2.8"
WARRANTY	Lifetime LED Warranty



GloLight

FUSION

STL201 GLOLIGHT® SERIES

GloLight® FUSION™ 4" Round Sealed Stop/Turn/Tail/Back-Up Light with Mounting Flange

PATENTED TECHNOLOGY

- Sonically sealed, waterproof
- Multi-function: Stop, turn, tail and back-up, all in one light
- Flange mount for security, theft reduction
- Weathertight connection standard



BULK P/N	POLYPACK P/N	DESCRIPTION	QTY
RED STOP/TURN/TAIL/BACK-UP LIGHT - 24 DIODES			
STL201RFMB	STL201RFMBP	Weathertight connection	10
ACCESSORIES			
A45PMB	A45PMBP	Weathertight pigtail, 3-wire	50
A42PMB	A42PMBP	Weathertight pigtail, 2-wire	100

FMVSS	S2 T2 I6 (2)R
MATERIALS	Polycarbonate lens and housing
VOLT/AMP	12.8VDC - .445A Stop/Turn, .265A Tail, .3A Back-Up
WT/DIMS	.38 lbs. / 5.5" x 5.5" x 1.53"
WARRANTY	Lifetime LED Warranty

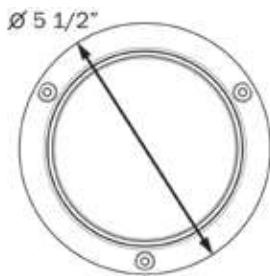
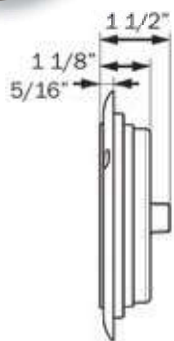

HOLE CUT-OUT: 4.5"



Weathertight connection

STL201 SERIES FUSION™ 4" Round Sealed Stop/Turn/Tail/Back-Up Light

- Sonically sealed, waterproof
- Multi-function: Stop, turn, tail and back-up, all in one light
- Accepts standard PL-3 plugs



LED FUSION TAIL LIGHTS

BULK P/N	POLYPACK P/N	DESCRIPTION	QTY
RED STOP/TURN/TAIL/BACK-UP LIGHT - 16 DIODES			
STL201RB	STL201RBP	PL-3 connections	10
ACCESSORIES			
A45GB	A45GBP	Grommet	50
A45PB	A45PBP	Straight pigtail, 3-wire PL-3	100
A47PB	A47PBP	Right angle pigtail, 3-wire PL-3	100
A45CB	A45CBP	Pigtail, 2-wire	100
A49PB	A49PBP	Right angle pigtail, 2-wire	100
BK45BB	BK45BBP	Black steel bracket	10

FMVSS	S2 T2 I6 (2)R
MATERIALS	Polycarbonate lens and housing
VOLT/AMP	12.8VDC - .375A Stop/Turn, .145A Tail, .3A Back-Up
WT/DIMS	.35 lbs. / 4.313" x 4.313" x 2"
WARRANTY	Lifetime LED Warranty



Standard PL3 connections

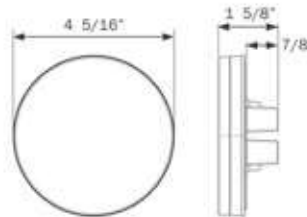

HOLE CUT-OUT: 4.5"



STL211 SERIES FUSION™ 6" Oval Sealed LED Stop/Turn/Tail/Back-Up Lights



STL211RB

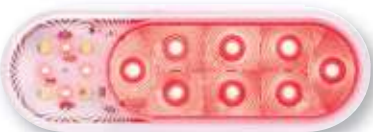

STL211RCB

- Sonically sealed, waterproof
- Multi-function: Stop, turn, tail and back-up, all in one light
- Accepts standard PL-3 plugs

BULK P/N	POLYPACK P/N	DESCRIPTION	QTY
RED STOP/TURN/TAIL/BACK-UP LIGHT - 16 DIODES			
STL211RB	STL211RBP	Red lens, PL-3 connection	10
STL211RCB	STL211RCBP	Clear lens, PL-3 connection	10
ACCESSORIES			
A70GB	A70GBP	Grommet, flush mount	50
A45PB	A45PBP	Pigtail, 3-wire	100
A47PB	A47PBP	Right angle pigtail, 3-wire	100
A45CB	A45CBP	Pigtail, 2-wire	100
A49PB	A49PBP	Right angle pigtail, 2-wire	100
A77SB	A77SBP	Grey steel bracket	20
BK70BB	BK70BBP	Black steel bracket	10

FMVSS	S2 T2 I6 (2)R
MATERIALS	Polycarbonate lens and housing
VOLT/AMP	12.8VDC - .375A Stop/Turn, .020A Tail, .242A Back-Up
WT/DIMS	.35 lbs. / 6.438" x 2.313" x 1.50"
WARRANTY	Lifetime LED Warranty

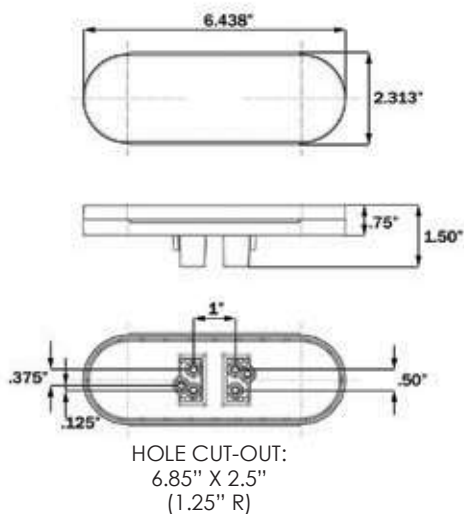

Standard PL3 connections

STL68 SERIES

FUSION™ Surface Mount LED Combination Stop/Turn/Tail/Back-Up Light



PATENTED TECHNOLOGY

- Sonically sealed, waterproof
- Low profile design—only 1/2" thick
- Surface mount on 9-11/16" centers
- Hard wired with separate ground wire

BULK P/N	POLYPACK P/N	DESCRIPTION	QTY
STOP/TURN/TAIL/BACK-UP LIGHT - 14 DIODES			
STL68RB	STL68RBP	Red, hard wired	10
STL68RPB	STI68RPBP	Red, .180 male bullets	10
ACCESSORIES			
A68SSB	A68SSBP	Stainless steel snap-on ring	20

FMVSS	S2 T2 I6 (2)R
MATERIALS	Polycarbonate lens and housing
VOLT/AMP	12.8VDC - .35A Stop/Turn, .05A Tail, .3A Back-up
WT/DIMS	.275 lbs. / 10.125" x 3.063" x 0.5"
WARRANTY	Lifetime LED Warranty



STL68RB



A68SSB

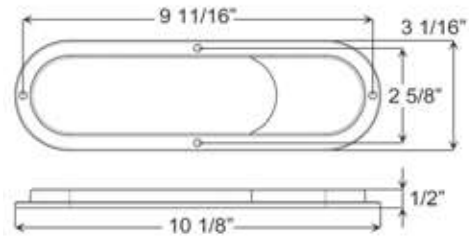

STL68RB

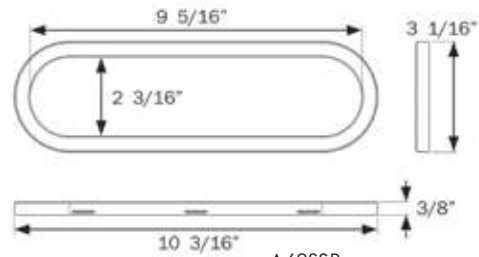

A68SSB

LED FUSION TAIL LIGHTS



STL101 GROMMET MOUNT SERIES GloLight® 4" Sealed LED Lights



PATENTED TECHNOLOGY

- Sonically sealed, waterproof
- Mount in any 360 degree position
- Available in tinted and clear lens models
- Available with standard PL-3 or optional weathertight connection

BULK P/N	POLYPACK P/N	DESCRIPTION	QTY
RED STOP/TURN/TAIL LIGHT - 21 DIODES			
STL101RB	STL101RBP	PL-3 connection	10
STL101RMB	STL101RMBP	Weathertight connection	10
STL101RCB	STL101RCBP	Clear lens, red diodes, PL-3	10
STL101RCMB	STL101RCMBP	Clear lens, red diodes, weathertight	10
STL101RKB	STL101RKBP	Kit: Red stop/turn/tail light, PL-3 connection, A45GB grommet, A47PB pigtail	10
YELLOW PARKING/TURN SIGNAL - 21 DIODES			
STL101AB	STL101ABP	PL-3 connection	10
STL101ACB	STL101ACBP	Clear lens, yellow diodes, PL-3	10
ACCESSORIES			
A45GB	A45GBP	Grommet	50
A45PB	A45PBP	Pigtail, 3-wire	100
A47PB	A47PBP	Right angle pigtail, 3-wire	100
A45PMB	A45PMBP	Weathertight pigtail	100
AL45PWTB	AL45PWTBP	Weathertight to PL-3 adaptor	50
BK45BB	BK45BBP	Black steel bracket	10
A45BB	A45BBP	Black plastic flange	100
A45SB	A45SBP	Stainless steel mounting flange	20
A45CGB	A45CGBP	Chrome grommet cover	20
FMVSS	Red S2 T2 I6; Yellow I6 P		
MATERIALS	Polycarbonate lens and housing		
VOLT/AMP	Red: 12.8VDC - .375A Stop/Turn, .145A Tail Yellow: 12.8VDC - .315A Turn, .143A Parking		
WT/DIMS	.35 lbs. / 4.313" dia x 1.375" D		
WARRANTY	Lifetime LED Warranty		

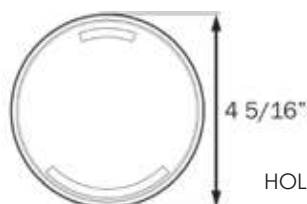

STL101 FLANGE MOUNT SERIES GloLight® 4" Sealed LED Lights with Mounting Flange

GloLight®

PATENTED TECHNOLOGY

- Sonically sealed, waterproof
- Flange mount for security, theft reduction
- Available in tinted and clear lens models
- Available with standard PL-3 or optional weathertight connection

BULK P/N	POLYPACK P/N	DESCRIPTION	QTY
RED STOP/TURN/TAIL LIGHT - 21 DIODES			
STL101RFB	STL101RFBP	PL-3 connection	10
STL101RFMB	STL101RFMBP	Weathertight connection	10
STL101RCFB	STL101RCFBP	Clear lens, red diodes, PL-3	10
STL101RCFMB	STL101RCFMBP	Clear lens, red diodes, weathertight	10

ACCESSORIES

A45PB	A45PBP	Pigtail, 3-wire	100
A47PB	A47PBP	Right angle pigtail, 3-wire	100
A45PMB	A45PMBP	Weathertight pigtail	100
AL45PWTB	AL45PWTBP	Weathertight to PL-3 adaptor	50
BK45BB	BK45BBP	Black steel bracket	10
A101TRSSB	A101TRSSBP	Stainless steel trim ring	50
A42GB	A42GBP	Mounting gasket, black	100

FMVSS	Red S2 T2 I6
MATERIALS	Polycarbonate lens and housing
VOLT/AMP	12.8VDC - .375 Stop/Turn, .145A Tail
WT/DIMS	.38 lbs. / 5.48" x 5.48" x 1.53"
WARRANTY	Lifetime LED Warranty

Industry-standard connections

Easy retrofit of lights to existing harness



Standard PL3 connection



Weathertight connection

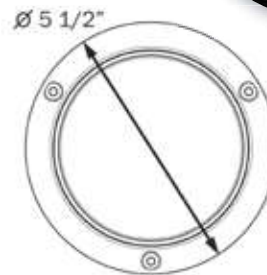
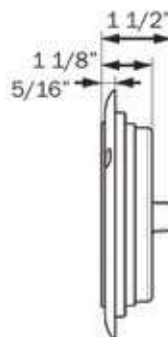

HOLE CUT-OUT: 4.5"

STOP/TURN

TAIL LIGHT

STL101RFB

STL101RCFB

LED SEALED STOP/TURN/TAIL & PARKING/TURN SIGNALS

GloLight®

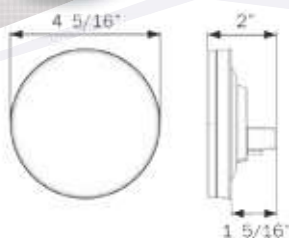

STL113 SERIES GloLight® 4" Round Sealed LED Lights

PATENTED TECHNOLOGY

- Unique mirrored reflector
- Sonically sealed, waterproof

BULK P/N	POLYPACK P/N	DESCRIPTION	QTY
RED STOP/TURN/TAIL LIGHT - 18 DIODES			
STL113RB	STL113RBP	PL-3 connection	10

FMVSS	S2 T2 I6
MATERIALS	Polycarbonate lens and housing
VOLT/AMP	12.8VDC - .375A Stop/Turn, .145A Tail
WT/DIMS	.35 lbs. / 4.313" x 4.313" x 2"
WARRANTY	Lifetime LED Warranty

HD500 SERIES

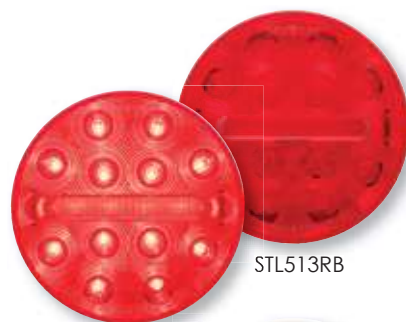

STL513RB



STL513RCB

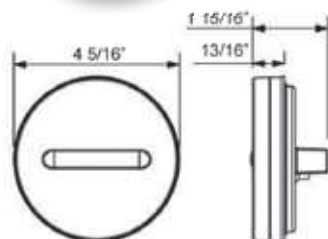

STL513 Series HD500™ 4" Round Sealed LED Lights

- Sonically sealed, waterproof
- Available in tinted and clear lens models

BULK P/N	POLYPACK P/N	DESCRIPTION	QTY
RED STOP/TURN/TAIL LIGHT - 18 DIODES			
STL513RB	STL513RBP	PL-3 connection	10
STL513RCB	STL513RCBP	Clear lens, red diodes, PL-3	10

FMVSS	S2 T2 I6
MATERIALS	Polycarbonate lens and housing
VOLT/AMP	12.8VDC - .435A Stop/Turn, .042A Tail
WT/DIMS	.287 lbs. / 4.313" x 4.313" x 1.938"
WARRANTY	Lifetime LED Warranty

STL113 & STL513 ACCESSORIES

A45GB	A45GBP	PVC grommet, flush mount	50
A45PB	A45PBP	Straight pigtail, 3-wire PL-3	100
A47PB	A47PBP	Right angle pigtail, 3-wire PL-3	100
BK45BB	BK45BBP	Black steel bracket	10
A45BB	A45BBP	Black mounting flange	100
A45SB	A45SBP	Stainless steel mounting flange	20
A45CGB	A45CGBP	Chrome trim ring	20

STL43 SERIES 4" Round Sealed LED Lights

- Sonically sealed, waterproof
- Kits include grommet and plug
- Mount in any 360 degree position
- Available in 12V and 24V models
- Available with standard PL-3 or optional weathertight connection



STL43RB



STL53RCB

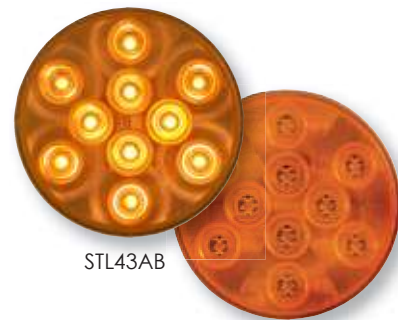

STL43AB

BULK P/N	POLYPACK P/N	DESCRIPTION	QTY
RED STOP/TURN/TAIL LIGHT - 10 DIODES			
STL43RB	STL43RBP	PL-3 connection, 12V	10
STL43RKB	STL43RKBP	Kit with A45GB & A47PB, PL-3, 12V	10
STL43R24B	STL43R24BP	PL-3 connection, 24V	10
STL43RMB	STL43RMBP	Weathertight connection, 12V	10
STL53RCB	STL53RCBP	Clear lens, red diode, PL-3	10
YELLOW PARKING/TURN SIGNAL - 10 DIODES			
STL43AB	STL43ABP	PL-3 connection, 12V	10
STL43A24B	STL43A24BP	PL-3 connection, 24V	10
STL43AKB	STL43AKBP	Kit with A45GB & A47PB, PL-3, 12V	10
ACCESSORIES			
A45GB	A45GBP	Grommet	50
A45PB	A45PBP	Pigtail, 3-wire PL-3	100
A47PB	A47PBP	Right angle pigtail, 3-wire PL-3	100
A45PMB	A45PMBP	Weathertight pigtail	100
AL45PWTB	AL45PWTBP	Weathertight to PL-3 adaptor	50
BK45BB	BK45BBP	Black steel bracket	10
A45BB	A45BBP	Black plastic flange	100
A45SB	A45SBP	Stainless steel mounting flange	20
A45CGB	A45CGBP	Chrome grommet cover	20
RETAIL			
STL43RK		12V kit with A45GB & A47PB, clam	6

FMVSS	Red S T I P2; Yellow I6 P
MATERIALS	Polycarbonate lens and housing
VOLT/AMP	Red: 12.8VDC - .360A Stop/Turn, .030A Tail Yellow: 12.8VDC - .310A Turn, .046A Parking
WT/DIMS	.265 lbs. / 4.313" x 4.313" x 1.938"
WARRANTY	Lifetime LED Warranty

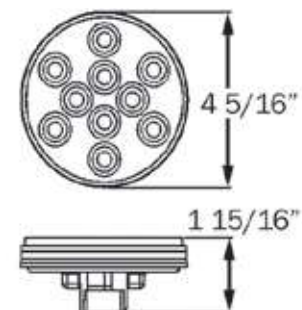

HOLE CUT-OUT: 4.5"

LED SEALED STOP/TURN/TAIL & PARKING/TURN SIGNALS



STL42 SERIES 4" Round Sealed LED Lights with Mounting Flange

- Sonically sealed, waterproof
- Flange mount for security, theft reduction
- Red available with standard PL-3 or optional weathertight connection



STL42RB



STL42AB



A42GB

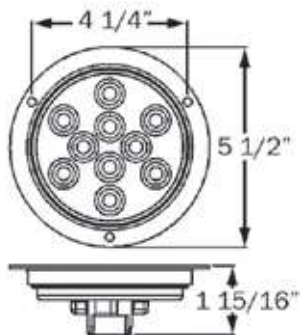

HOLE CUT-OUT: 4.5"

BULK P/N	POLYPACK P/N	DESCRIPTION	QTY
----------	--------------	-------------	-----

RED STOP/TURN/TAIL LIGHT - 10 DIODES

STL42RB	STL42RBP	Black flange, PL-3	10
STL42RMB	STL42RMBP	Black flange, weathertight	10
STL42RMBK	STL42RMBKP	Kit: Red stop/turn/tail light with weathertight connection, AL45PWTB pigtail	10

YELLOW PARKING/TURN SIGNAL - 10 DIODES

STL42AB	STL42ABP	Black flange, PL-3	10
STL42AMB	STL42AMBP	Black flange, weathertight	10

ACCESSORIES

A45PB	A45PBP	Pigtail, 3-wire PL-3	100
A47PB	A47PBP	Right angle pigtail, 3-wire PL-3	100
A45PMB	A45PMBP	Weathertight pigtail	100
AL45PWTB	AL45PWTBP	Weathertight to PL-3 adaptor	50
BK45BB	BK45BBP	Black steel bracket	10
A42FCB	A42FCBP	Chrome flange cover	100
A5TRSSB	A5TRSSBP	Stainless steel trim ring	100
A42GB	A42GBP	Mounting gasket, black	100

RETAIL

STL42RS		Light only, clam	6
---------	---	------------------	---

FMVSS	Red S T I P2; Yellow I6 P
MATERIALS	Polycarbonate lens and housing
VOLT/AMP	Red: 12.8VDC - .413 Stop/Turn, .026A Tail Yellow: 12.8VDC - .310 Turn, .046A Parking
WT/DIMS	.617 lbs. / 5.5" x 5.5" x 1.938"
WARRANTY	Lifetime LED Warranty

STL43 REFLEX FLANGE SERIES

4" Round Sealed LED Lights with Reflex Mounting Flange

- Sonically sealed, waterproof
- Flange mount for security, theft reduction
- Accepts standard PL-3 connector
- Reflex flange meets SAE A for reflector



STL43RBX



STL43ABX

BULK P/N	POLYPACK P/N	DESCRIPTION	QTY
RED STOP/TURN/TAIL LIGHT - 10 DIODES			
STL43RBX	STL43RBXP	Red reflex flange, gasket, PL-3	10
STL43RBHX	STL43RBHXP	Red reflex flange, hard wire, gasket	10
YELLOW PARKING/TURN SIGNAL - 10 DIODES			
STL43ABX	STL43ABXP	Yellow reflex flange, gasket	10
ACCESSORIES			
A45PB	A45PBP	Pigtail, 3-wire PL-3	100
A47PB	A47PBP	Right angle pigtail, 3-wire PL-3	100
RETAIL			
STL43ABXS		Yellow light only, clam	6
STL43RBXS		Red light only, clam	6

FMVSS	Red S T I; Yellow I6 P; Reflex A
MATERIALS	Polycarbonate lens and housing
VOLT/AMP	Red: 12.8VDC - .413 Stop/Turn, .026A Tail Yellow: 12.8VDC - .310 Turn, .046A Parking
WT/DIMS	.397 lbs. / 5.75" x 5.75" x 1.625"
WARRANTY	Lifetime LED Warranty

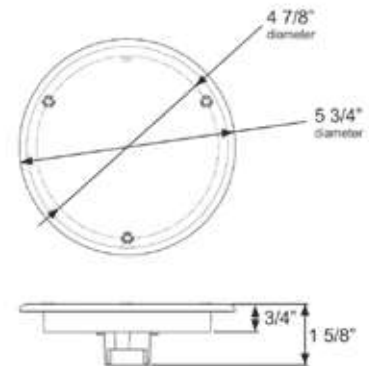

HOLE CUT-OUT: 4.5"

LED SEALED STOP/TURN/TAIL & PARKING/TURN SIGNALS



STL13RB



HOLE CUT-
OUT: 4.5"



STL13RFB

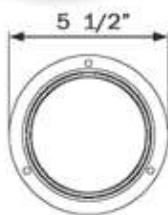

HOLE CUT-
OUT: 4.5"

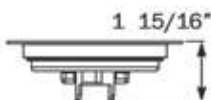

STL13RGB male pin
connection



STL13 SERIES

FLEET Count™ 4" Round Sealed LED Stop/Turn/Tail Lights

- Sonically sealed, waterproof
- Available in grommet and flange mount models
- Available with standard PL-3, male pin, weathertight or hard wired connections
- Retail kit includes grommet and plug

BULK P/N	POLYPACK P/N	DESCRIPTION	QTY
RED STOP/TURN/TAILO - 7 DIODES			
STL13RB	STL13RBP	PL-3 connection	10
STL13RMB	STL13RMBP	Weathertight connection	10
STL13RGB	STL13RGBP	Male pin connection	10
STL13RH1B	STL13RH1BP	Hard wired, PL-3 female plug	10
STL13RH3B	STL13RH3BP	Hard wired, .180 male bullets	10
STL13RFB	STL13RFBP	Flange, PL-3	10
STL13RFMB	STL13RFMBP	Flange, weathertight	10
STL13RKB	STL13RKBP	Kit: with A45GB grommet and A45PB plug, PL-3 connection	

ACCESSORIES			
A45GB	A45GBP	Grommet	50
A45PB	A45PBP	Pigtail, 3-wire PL-3	100
A47PB	A47PBP	Right angle pigtail, 3-wire PL-3	100
A45PMB	A45PMBP	Weathertight pigtail	100
AL45PWTB	AL45PWTBP	Weathertight to PL-3 adaptor	50
BK45BB	BK45BBP	Black steel bracket	10
A45BB	A45BBP	Black plastic flange	100
A45SB	A45SBP	Stainless steel flange	20
A42FCB	A42FCBP	Chrome flange cover	100
A5TRSSB	A5TRSSBP	Stainless steel trim ring	100
A45CGB	A45CGBP	Chrome grommet cover	20

RETAIL			
STL13RK		Kit with A45GB & A47PB, clam	6
STL13RS		Light only, clam	6
STL13RFS		Flange mount light only, clam	6

FMVSS	ST I
MATERIALS	Polycarbonate lens and housing
VOLT/AMP	12.8VDC - .234A Stop/Turn, .033A Tail
WT/DIMS	STL13 grommet mount: .265 lbs. / 4.31" x 4.31" x 1.81" STL13 flange mount: .275 lbs. / 5.5" x 5.5" x 1.938"
WARRANTY	Lifetime LED Warranty

STL413 Series FLEET Count™ 4" Round Sealed LED Lights



- Sonically sealed, waterproof
- Mount in any 360° position
- Available in standard PL-3 or optional weathertight connection



STL413RB



BULK P/N	POLYPACK P/N	DESCRIPTION	QTY
RED STOP/TURN/TAIL LIGHT - 4 DIODES			
STL413RB	STL413RBP	PL-3 connection	10
STL413RMB	STL413RMBP	Weathertight connecton	10
ACCESSORIES			
A45GB	A45GBP	Grommet	50
A45PB	A45PBP	Straight pigtail, 3-wire PL-3	100
A47PB	A47PBP	Right angle pigtail, 3-wire PL-3	100
A45PMB	A45PMBP	Weathertight pigtail, 3-wire	50
AL45PWTB	AL45PWTBP	Weathertight pigtail to PL-3	50
A45BB	A45BBP	Black mounting flange	100
A45SB	A45SBP	Stainless steel mounting flange	20
BK45BB	BK45BBP	Black steel bracket	10

FMVSS	S2 T2 I6
MATERIALS	Polycarbonate lens and housing
VOLT/AMP	12.8VDC - .160A Stop/Turn, .008A Tail
WT/DIMS	.265 lbs. / 4.313" x 4.313" x 1.625"
WARRANTY	Lifetime LED Warranty

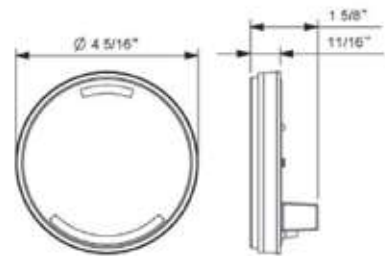

HOLE CUT-OUT: 4.5"

Industry-standard connections
Easy retrofit of lights to existing harness



Standard PL3 connection



Weathertight connection



STL003 Series ONE™ LED 4" Round Sealed Lights

- Sonically sealed, waterproof
- Mount in any 360° position
- Available in grommet and flange mount models with PL-3 and weathertight connections



STL003RB



STL003AB



STL003SRFLB

PATENT PENDING



BULK P/N	POLYPACK P/N	DESCRIPTION	QTY
RED STOP/TURN/TAIL LIGHT - 1 DIODE			
STL003RB	STL003RBP	PL-3 connection	10
STL003RFB	STL003RFBP	Flange mount, PL-3 connection	10
STL003RFLB	STL003RFLBP	Flange mount, locking PL-3 connection	10
STL003SRFLB	STL003SRFLBP	LampLock™ snap-in flange mount, locking PL-3 connection, adhesive gasket	10
STL003RFMB	STL003RFMBP	Flange mount, weathertight connection	10
STL003RMB	STL003RMBP	Weathertight connection	50
YELLOW PARKING/TURN SIGNAL - 1 DIODE			
STL003AB	STL003ABP	PL-3 connection	50
ACCESSORIES			
A45GB	A45GBP	PVC grommet, flush mount	50
A45PB	A45PBP	Straight pigtail, 3-wire PL-3	100
A47PB	A47PBP	Right angle pigtail, 3-wire PL-3	100
AL45PWTB	AL45PWTBP	Weathertight pigtail, plug to female PL-3	50
A45PMB	A45PMBP	Weathertight 3-wire pigtail, plug to bare wire	50

For more details on mounting and wiring accessories, see Accessories section at back of catalog.

RETAIL

STL003RK		Kit with grommet and pigtail, clam	6
STL003RS		Light only, clam	6

FMVSS	Red: S T I, Yellow: I P
MATERIALS	Polycarbonate lens and housing
VOLT/AMP	12.8VDC - .25A Stop/Turn, .007A Tail
WT/DIMS	Grommet mount: .35 lbs. / 4.313" x 4.313" (depth varies) Flange mount: .275 lbs. / 5.5" x 5.5" (depth varies)
WARRANTY	Lifetime LED Warranty

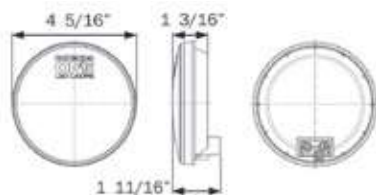

Grommet mount, PL-3

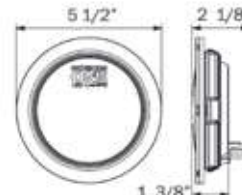

STL003SRFLB

STL23 SERIES

Miro-Flex™ 4" Round Sealed LED Lights

- Sonically sealed, waterproof
- Mount in any 360 degree position
- Accepts standard PL-3 plugs
- Available in 12V and 24V models

BULK P/N	POLYPACK P/N	DESCRIPTION	QTY
RED STOP/TURN/TAIL - 12 DIODES			
STL23RB	STL23RBP	PL-3 connection, 12V	10
STL23CCRB	STL23CCRBP	Clear lens, red reflector, PL-3, 12V	10
STL23R24B	STL23R24BP	PL-3 connection, 24V	10
YELLOW PARKING/TURN SIGNAL - 16 DIODES			
STL23AB	STL23ABP	PL-3 connection, 12V	10
STL23A24B	STL23A24BP	PL-3 connection, 24V	10
ACCESSORIES			
A45GB	A45GBP	Grommet	50
A45PB	A45PBP	Pigtail, 3-wire PL-3	100
A47PB	A47PBP	Right angle pigtail, 3-wire PL-3	100
BK45BB	BK45BBP	Black steel bracket	10
A45BB	A45BBP	Black plastic flange	100
A45SB	A45SBP	Stainless steel flange	20
A45CGB	A45CGBP	Chrome grommet cover	20

FMVSS	Red S T I; Yellow I P
MATERIALS	Polycarbonate lens and housing
VOLT/AMP	Red: 12.8VDC - .208 Stop/Turn, .013A Tail 24.0VDC - .171 Stop/Turn, .061A Tail Yellow: 12.8VDC - .310 Turn, .046A Parking 24.0VDC - .171 Stop/Turn, .061A Tail
WT/DIMS	.265 lbs. / 4.313" x 4.313" x 1.938"
WARRANTY	Lifetime LED Warranty



STL23RB



STL23CCRB



STL23AB

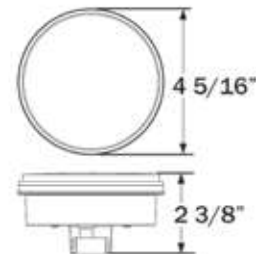

HOLE CUT-OUT: 4.5"

LED SEALED STOP/TURN/TAIL & PARKING/TURN SIGNALS

HYPERX®

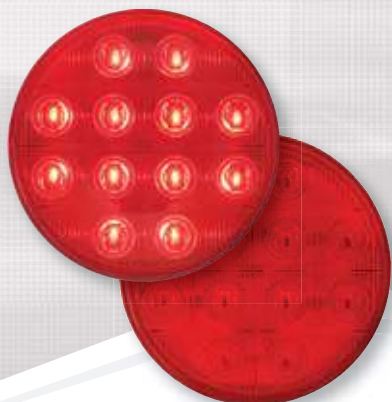

STL543RB

STL543 SERIES HyperX® 4" Round Sealed LED Stop/Turn/Tail Light

- Sonically sealed, waterproof
- Mount in any 360 degree position
- Accepts standard PL-3 plugs
- 12 diodes and contemporary, automotive style optics

BULK P/N	POLYPACK P/N	DESCRIPTION	QTY
RED STOP/TURN/TAILO - 12 DIODES			
STL543RB	STL543RBP	PL-3 connection	10
ACCESSORIES			
A45GB	A45GBP	Grommet	50
A45PB	A45PBP	Pigtail, 3-wire PL-3	100
A47PB	A47PBP	Right angle pigtail, 3-wire PL-3	100
BK45BB	BK45BBP	Black steel bracket	10
A45BB	A45BBP	Black plastic flange	100
A45SB	A45SBP	Stainless steel flange	20
A45CGB	A45CGBP	Chrome grommet cover	20

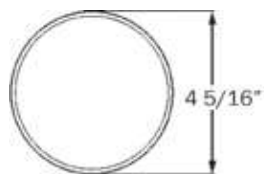

HOLE CUT-OUT: 4.5"

FMVSS	ST I
MATERIALS	Polycarbonate lens and housing
VOLT/AMP	12.8VDC - .208 Stop/Turn, .013A Tail
WT/DIMS	.265 lbs. / 4.313" x 4.313" x 1.938"
WARRANTY	Lifetime LED Warranty

STL55 SERIES

High LED Count 4" Round Sealed Lights for Recess Mount

- Sonically sealed, waterproof
- 21 LEDs for high diode count appearance
- Mount in any 360 degree position
- Accepts standard PL-3 plugs; red available with optional weathertight connection

**HIGH
LED
COUNT**

**optronics
LED**

LED SEALED STOP/TURN/TAIL &
PARKING/TURN SIGNALS

BULK P/N	POLYPACK P/N	DESCRIPTION	QTY
RED STOP/TURN/TAIL - 21 DIODES			
STL55RB	STL55RBP	Grommet mount, PL-3 connection	10
STL55RFMB	STL55RFMBP	Flange mount, weathertight connection	10
YELLOW PARKING/TURN SIGNAL - 21 DIODES			
STL55AB	STL55ABP	Grommet mount, PL-3 connection	10
ACCESSORIES			
A45GB	A45GBP	Grommet	50
A45PB	A45PBP	Pigtail, 3-wire PL-3	100
A47PB	A47PBP	Right angle pigtail, 3-wire PL-3	100
A45PMB	A45PMBP	Weathertight pigtail	100
AL45PWTB	AL45PWTBP	Weathertight to PL-3 adaptor	50
BK45BB	BK45BBP	Black steel bracket	10
A45BB	A45BBP	Black plastic flange	100
A45SB	A45SBP	Stainless steel flange	20
A45CGB	A45CGBP	Chrome grommet cover	20

FMVSS	Red S T I; Yellow I6 P
MATERIALS	Polycarbonate lens and housing
VOLT/AMP	Red: 12.8VDC - .208 Stop/Turn, .013A Tail Yellow: 12.8VDC - .310 Turn, .046A Parking
WT/DIMS	Grommet mount: .265 lbs. / 4.313" x 4.313" x 1.5" Flange mount: .265 lbs. / 5.5" x 5.5" x 1.5"
WARRANTY	Lifetime LED Warranty

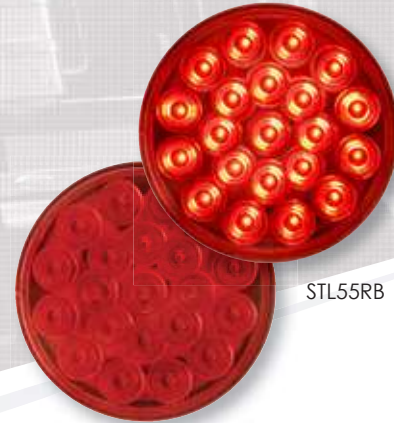

STL55RB



STL55RFMB



STL55AB

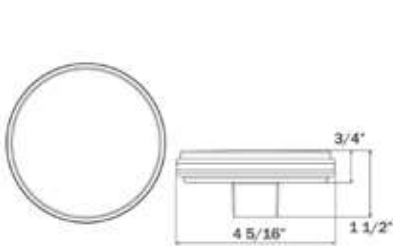

HOLE CUT-OUT: 4.5"

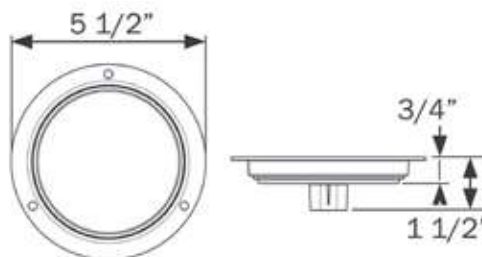

HOLE CUT-OUT: 4.5"



STL111 GROMMET MOUNT SERIES GloLight® 6" Sealed LED Lights



STL111RB



STL111RCB



STL111AB



STL111ACB



TLL112RK

PATENTED TECHNOLOGY

- Sonically sealed, waterproof
- Mount in any 360 degree position
- Available in tinted and clear lens models
- Available with standard PL-3 or optional weathertight connection

BULK P/N	POLYPACK P/N	DESCRIPTION	QTY
RED STOP/TURN/TAIL LIGHT - 22 DIODES			
STL111RB	STL111RBP	PL-3	10
STL111RMB	STL111RMBP	Weathertight	10
STL111RHB	STL111RHBP	Hard wired	10
STL111RCB	STL111RCBP	Clear lens, red diodes, PL-3	10
STL111RCMB	STL111RCMBP	Clear lens, red diodes, weathertight	10
YELLOW PARKING/TURN SIGNAL - 22 DIODES			
STL111AB	STL111ABP	PL-3	10
STL111ACB	STL111ACBP	Clear lens, yellow diodes, PL-3	10
ACCESSORIES			
A70GB	A70GBP	Grommet	50
A45PB	A45PBP	Pigtail, 3-wire	100
A47PB	A47PBP	Right angle pigtail, 3-wire	100
A45PMB	A45PMBP	Weathertight pigtail	100
AL45PWTB	AL45PWTBP	Weathertight to PL-3 adaptor	50
BK70BB	BK70BBP	Black steel bracket	10
A77SB	A77SBP	Gray steel bracket	20
RETAIL			
TLL112RK		Try Me kit with (2) ea. STL111RB, A70GB and A47PB, clam	2
FMVSS	Red S2 T2 I6; Yellow I6 P		
MATERIALS	Polycarbonate lens and housing		
VOLT/AMP	Red: 12.8VDC - .59A Stop/Turn, .295A Tail Yellow: 12.8VDC - .515A Turn, .27A Parking		
WT/DIMS	.35 lbs. / 6.5" x 2.25" x 1.75"		
WARRANTY	Lifetime LED Warranty		



HOLE CUT-OUT: 6.85" X 2.5" (1.25" R)

STL111 FLANGE MOUNT SERIES GloLight® 6" Sealed LED Lights with Mounting Flange

GloLight®

PATENTED TECHNOLOGY

- Sonically sealed, waterproof
- Recess flange mount for security, theft reduction
- Available in tinted and clear lens models
- Available with standard PL-3 or optional weathertight connection

BULK P/N	POLYPACK P/N	DESCRIPTION	QTY
RED STOP/TURN/TAIL LIGHT - 22 DIODES			
STL111RFB	STL111RFBP	PL-3 connection	10
STL111RFMB	STL111RFMBP	Weathertight connection	10
STL111RCFB	STL111RCFBP	Clear lens, red diodes, PL-3	10
STL111RCFMB	STL111RCFMBP	Clear lens, red diodes, weathertight	10
ACCESSORIES			
A45PB	A45PBP	Pigtail, 3-wire	100
A47PB	A47PBP	Right angle pigtail, 3-wire	100
A45PMB	A45PMBP	Weathertight pigtail	100
AL45PWTB	AL45PWTBP	Weathertight to PL-3 adaptor	50
BK70BB	BK70BBP	Black steel bracket	10
A77SB	A77SBP	Gray steel bracket	20
A111TRSSB	A111TRSSBP	Stainless steel trim ring	50

FMVSS	Red S2 T2 I6
MATERIALS	Polycarbonate lens and housing
VOLT/AMP	12.8VDC - .59 Stop/Turn, .295A Tail
WT/DIMS	.38 lbs. / 7.5" x 3.3" x 1.938"
WARRANTY	Lifetime LED Warranty

TAIL
LIGHT



STOP/
TURN



STL111RFB



STL111RCFB

LED SEALED STOP/TURN/TAIL &
PARKING/TURN SIGNALS

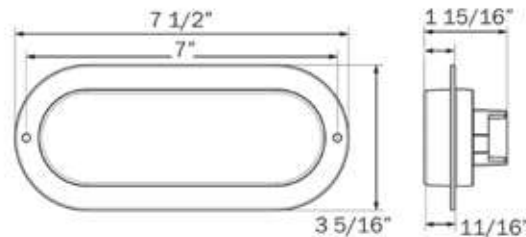

HOLE CUT-OUT: 6.85" X 2.5" (1.25" R)



STL178 SERIES GloLight® 6" Sealed LED Stop/Turn/Tail Lights for Surface Mount



TAIL LIGHT



STOP/TURN

STL178RB



STL178RCFPB



STL178RCCFPB

PATENTED TECHNOLOGY

- Sonically sealed, waterproof
- Mount in any 360 degree position
- Flange surface mount—no panel cut-out required
- Hard wired, with optional molded connectors
- Available in tinted and clear lens models

BULK P/N	POLYPACK P/N	DESCRIPTION	QTY
RED STOP/TURN/TAIL LIGHT - 22 DIODES			
STL178RB	STL178RBP	Hard wired	10
STL178RFPB	STL178RFPBP	Hard wired, female PL-3 plug	10
STL178RCFPB	STL178RCFPBP	Clear lens & glow ring, red diodes, hard wired with female PL-3 connector	10
STL178RCCFPB	STL178RCCFPBP	Clear lens, red diodes, hard wired with female PL-3 connector	10
ACCESSORIES			
BK70BB	BK70BBP	Black steel bracket	10
A77SB	A77SBP	Gray steel bracket	20
A178TRSSB	A178TRSSBP	Stainless steel trim ring	50

FMVSS	S2 T2 I6
MATERIALS	Polycarbonate lens and housing
VOLT/AMP	12.8VDC - .59 Stop/Turn, .295A Tail
WT/DIMS	.38 lbs. / 7.5" x 3.3" x 1.1"
WARRANTY	Lifetime LED Warranty

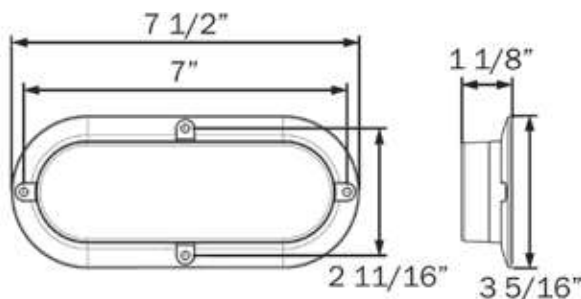

STL112 SERIES GloLight® 6" Sealed LED Lights

- Unique mirrored reflector
- Sonically sealed, waterproof
- Mount in any 360° position
- Accepts standard PL-3 connector

PATENTED
TECHNOLOGY

GloLight®

BULK P/N	POLYPACK P/N	DESCRIPTION	QTY
RED STOP/TURN/TAIL LIGHT - 22 DIODES			
STL112RB	STL112RBP	PL-3 connection	10
ACCESSORIES			
A70GB	A70GBP	Grommet	50
A45PB	A45PBP	Pigtail, 3-wire	100
A47PB	A47PBP	Right angle pigtail, 3-wire	100
BK70BB	BK70BBP	Black steel bracket	10
A77SB	A77SBP	Gray steel bracket	20
FMVSS	S T I		
MATERIALS	Polycarbonate lens and housing		
VOLT/AMP	12.8VDC - .59A Stop/Turn, .295A Tail		
WT/DIMS	.38 lbs. / 6.438" x 2.313" x 1.938"		
WARRANTY	Lifetime LED Warranty		

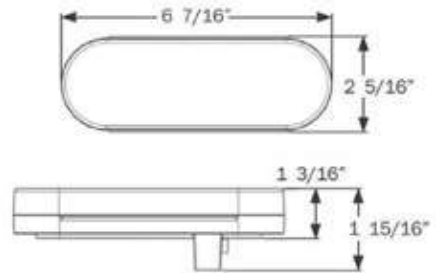

LED SEALED STOP/TURN/TAIL &
PARKING/TURN SIGNALS

STL512 SERIES HD500™ 6" Sealed LED Lights

- Sonically sealed, waterproof
- Available in tinted and clear lens models

BULK P/N	POLYPACK P/N	DESCRIPTION	QTY
RED STOP/TURN/TAIL LIGHT - 18 DIODES			
STL512RB	STL512RBP	PL-3 connection	10
STL512RCB	STL512RCBP	Weathertight connection	10
ACCESSORIES			
A70GB	A70GBP	Grommet	50
A45PB	A45PBP	Pigtail, 3-wire	100
A47PB	A47PBP	Right angle pigtail, 3-wire	100
BK70BB	BK70BBP	Black steel bracket	10
FMVSS	S T I		
MATERIALS	Polycarbonate lens and housing		
VOLT/AMP	12.8VDC - .294A Stop/Turn, .024A Tail		
WT/DIMS	.262 lbs. / 6.50" x 2.313" x 1.84"		
WARRANTY	Lifetime LED Warranty		

HD500
SERIES

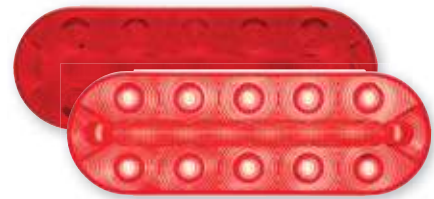

STL512RB



STL512RCB

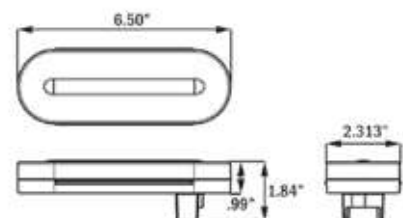



STL72RB



STL82RCB



STL72AB



STL72CAB

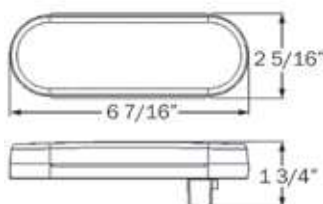

HOLE CUT-OUT: 6.85" X 2.5" (1.25" R)

STL72/82 SERIES 6" Oval Sealed LED Lights

- Sonically sealed, waterproof
- Kits include grommet and plug
- Mount in any 360 degree position
- Available with standard PL-3 or optional weathertight connection

BULK P/N	POLYPACK P/N	DESCRIPTION	QTY
RED STOP/TURN/TAIL LIGHT - 10 DIODES			
STL72RB	STL72RBP	PL-3 connection	10
STL72RKB	STL72RKBP	Kit with A70GB, PL-3	10
STL74RBK	STL74RBKP	Kit with A70GB & A47PB, PL-3	50
STL74RKB	STL74RKBP	Kit with A70GB & A45PB, PL-3	10
STL72RMB	STL72RMBP	Weathertight connection	10
STL82RCB	STL82RCBP	Clear lens, red diodes, PL-3	10
YELLOW PARKING/TURN SIGNAL - 10 DIODES			
STL72AB	STL72ABP	PL-3	10
STL72AMB	STL72AMBP	Weathertight connection	10
STL72CAB	STL72CABP	Clear lens, amber diodes, PL-3	10
ACCESSORIES			
A70GB	A70GBP	Grommet	50
A45PB	A45PBP	Pigtail, 3-wire PL-3	100
A47PB	A47PBP	Right angle pigtail, 3-wire PL-3	100
A45PMB	A45PMBP	Weathertight pigtail	100
AL45PWTB	AL45PWTBP	Weathertight to PL-3 adaptor	50
BK70BB	BK70BBP	Black steel bracket	10
A77SB	A77SBP	Gray steel bracket	20
RETAIL			
STL72RK		12V kit with A70GB & A47PB, clam	6
STL72RS		12V, clam	6

FMVSS	Red I6 P3 S2 T2; Yellow I6 P
MATERIALS	Polycarbonate lens and housing
VOLT/AMP	Red: 12.8VDC - .243A Stop/Turn, .046A Tail Yellow: 12.8VDC - .275A Turn, .042A Parking
WT/DIMS	.309 lbs. / 6.438" x 2.313" x 1.75"
WARRANTY	Lifetime LED Warranty

STL78/88 SERIES 6" Oval Sealed LED Lights for Surface Mount

- Sonically sealed, waterproof
- Mount in any 360 degree position
- Flange surface mount—no panel cut-out required
- Hard wired, with optional molded connectors

BULK P/N	POLYPACK P/N	DESCRIPTION	QTY
RED STOP/TURN/TAIL LIGHT - 10 DIODES			
STL78RB	STL78RBP	Hard wired	10
STL78RPG	STL78RPGP	.180 male bullets	10
STL78REZB	STL78REZBP	3-way female PL-3 plug	10
STL78RLPB	STL78RLPBP	Low profile 9/16" thick, female PL-3 plug, gasket included	10
STL88RCB	STL88RCBP	Clear lens, red diodes, hard wired	10
STL88RCPG	STL88RCPGP	Clear lens, red diodes, 3-way female PL-3 plug	10
YELLOW PARKING/TURN SIGNAL - 10 DIODES			
STL78AB	STL78ABP	Hard wired	10
ACCESSORIES			
A78CB1	A78CB1P	Chrome flange cover	25
A78RXB	A78RXBP	Red reflex flange cover & gasket	25
RETAIL			
STL78RK		Single light, clam	6



STL78RB



STL88RCB



STL78AB

FMVSS	Red I6 P3 S2 T2; Yellow I6 P
MATERIALS	Polycarbonate lens and housing
VOLT/AMP	Red: 12.8VDC - .243A Stop/Turn, .046A Tail Yellow: 12.8VDC - .275A Turn, .042A Parking
WT/DIMS	STL78/88: .265 lbs. / 7.563" x 3.313" x 0.750" STL78RLPB: .260 lbs. / 7.563" x 3.313" x .563"
WARRANTY	Lifetime LED Warranty

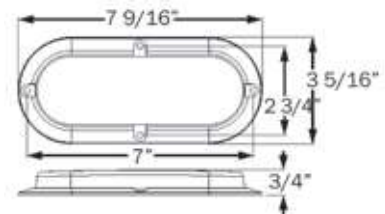

LED SEALED STOP/TURN/TAIL & PARKING/TURN SIGNALS



STL12RB

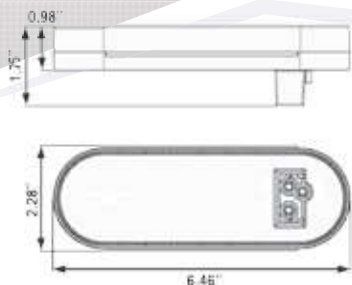

HOLE CUT-OUT: 6.85" X 2.5" (1.25" R)



TLL12RK

STL12 SERIES FLEET Count™ 6" Oval Sealed LED Stop/Turn/Tail Lights

- Sonically sealed, waterproof
- Available with standard PL-3 or optional weathertight connection
- Retail kit includes light, grommet and plug

BULK P/N	POLYPACK P/N	DESCRIPTION	QTY
RED STOP/TURN/TAIL - 6 DIODES			
STL12RB	STL12RBP	PL-3 connection	10
STL12RMB	STL12RMBP	Weathertight connection	10
STL12RK2B	-	Kit: STL12RB, A45PB, & A60GB	10
STL12RKB	-	Kit: STL12RB, A45PB, & A70GB	10
ACCESSORIES			
A70GB	A70GBP	Grommet	50
A45PB	A45PBP	Pigtail, 3-wire PL-3	100
A47PB	A47PBP	Right angle pigtail, 3-wire PL-3	100
A45PMB	A45PMBP	Weathertight pigtail	100
AL45PWTB	AL45PWTBP	Weathertight to PL-3 adaptor	50
BK70BB	BK70BBP	Black steel bracket for STL12RB	10
A77SB	A77SBP	Gray steel bracket for STL12RB	20
RETAIL			
STL12RK		Kit with A70GB & A47PB, clam	6
STL12RS		Light only, clam	6
TLL12RK		Kit with (2) each STL12RB, A70GB & A47PB, clam	2

FMVSS	S T I
MATERIALS	Polycarbonate lens and housing
VOLT/AMP	12.8VDC - .161A Stop/Turn, .007A Tail
WT/DIMS	.375 lbs. / 6.5" x 2.25" x 1.75"
WARRANTY	Lifetime LED Warranty

STL73 SERIES FLEET Count™ 6" Oval Sealed LED Stop/Turn/Tail Lights

- Sonically sealed, waterproof
- Flange surface mount is hard wired requiring no panel cut-out; includes ground

BULK P/N	POLYPACK P/N	DESCRIPTION	QTY
RED STOP/TURN/TAIL - 6 DIODES			
STL73RB	STL73RBP	Flange surface mount, hard wired	10
STL73RKB	STL73RKBP	Kit with STL78RB and A73GB gasket	10
ACCESSORIES			
A78CB1	A78CB1P	Chrome flange cover	25
RETAIL			
STL73RK		Kit with STL73RB and A78CB1, clam	6
FMVSS	S T I		
MATERIALS	Polycarbonate lens and housing		
VOLT/AMP	12.8VDC - .161A Stop/Turn, .007A Tail		
WT/DIMS	.287 lbs. / 7.563" x 3.313" x 0.75"		
WARRANTY	Lifetime LED Warranty		



STL73RB



A78CB1

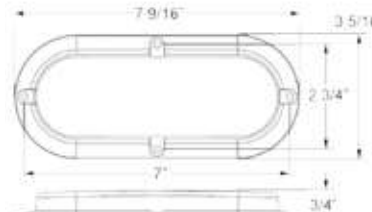

LED SEALED STOP/TURN/TAIL & PARKING/TURN SIGNALS

STL412 SERIES FLEET Count™ 6" Sealed LED Lights

- Sonically sealed, waterproof
- Mount in any 360° position
- Accepts standard PL-3 connector

BULK P/N	POLYPACK P/N	DESCRIPTION	QTY
RED STOP/TURN/TAIL LIGHT - 4 DIODES			
STL412RB	STL412RBP	PL-3 connection	10
ACCESSORIES			
A70GB	A70GBP	Grommet	50
A45PB	A45PBP	Pigtail, 3-wire	100
A47PB	A47PBP	Right angle pigtail, 3-wire	100
BK70BB	BK70BBP	Black steel bracket	10
A77SB	A77SBP	Gray steel bracket	20
FMVSS	S T I		
MATERIALS	Polycarbonate lens and housing		
VOLT/AMP	12.8VDC - .161A Stop/Turn, .007A Tail		
WT/DIMS	.375 lbs. / 6.438" x 2.313" x 1.75"		
WARRANTY	Lifetime LED Warranty		

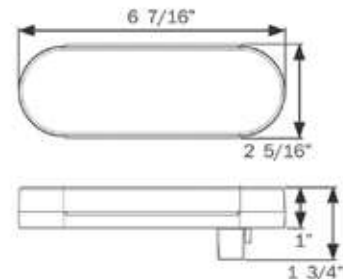



STL002 SERIES ONE™ 6" Sealed LED Lights

- Sonically sealed, waterproof
- Mount in any 360 degree position
- Available in grommet and flange mount models



STL002RB



STL002AB



STL002RFB

BULK P/N	POLYPACK P/N	DESCRIPTION	QTY
RED STOP/TURN/TAIL LIGHT - 1 DIODE			
STL002RB	STL002RBP	PL-3 connection	50
STL002RMB	STL002RMBP	Weathertight connection	50
STL002RFB	STL002RFBP	Flange mount, PL-3 connection	10
STL002RK2B	STL002RK2BP	Kit with A60GB and A47PB, PL-3	10
YELLOW PARKING/TURN SIGNAL - 1 DIODE			
STL002AB	STL002ABP	PL-3 connection	50
ACCESSORIES			
A70GB	A70GBP	Grommet	50
A45PB	A45PBP	Pigtail, 3-wire	100
A47PB	A47PBP	Right angle pigtail, 3-wire	100
BK70BB	BK70BBP	Black steel bracket	10
RETAIL			
STL002RK		Kit with grommet and plug, clam	6
STL002RS		Grommet mount light only, clam	6
TLL002RK		Set with (2) each STL002RB, A70GB and A47PB, clam	2

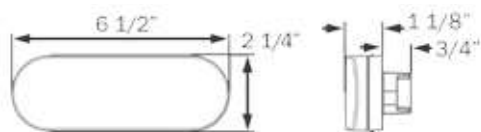

HOLE CUT-OUT: 6.85" x 2.5" (1.25" R)

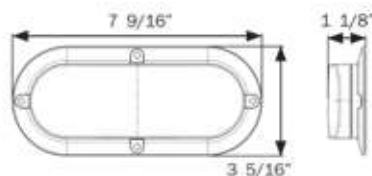

NO PANEL CUT-OUT REQUIRED

FMVSS	Red: S2 T2 I6, Yellow: I6 P
MATERIALS	Polycarbonate lens and housing
VOLT/AMP	12.8VDC - .25A Stop/Turn, .007A Tail
WT/DIMS	Grommet mount: .262 lbs. / 6.50" x 2.313" x 1.875" Flange mount: .262 lbs. / 7.563" x 3.313" x 1.125"
WARRANTY	Lifetime LED Warranty

STL22 SERIES

Miro-Flex™ 6" Oval Sealed LED Lights

- Sonically sealed, waterproof
- Mount in any 360 degree position
- Accepts standard PL-3 plugs
- Available with tinted or clear lens and chrome or tinted reflector

BULK P/N	POLYPACK P/N	DESCRIPTION	QTY
RED STOP/TURN/TAIL - 12 DIODES			
STL22RB	STL22RBP	PL-3 connection	10
STL22RBH	STL22RBHP	Hard wired	10
STL22CCRB	STL22CCRBP	Clear lens, red reflector, PL-3	10
STL22RCB	STL22RCBP	Clear lens, PL-3	10
YELLOW PARKING/TURN SIGNAL - 16 DIODES			
STL22AB	STL22ABP	PL-3 connection	10
STL22CCAB	STL22CCABP	Clear lens, yellow reflector, PL-3	10
ACCESSORIES			
A70GB	A70GBP	Grommet	50
A45PB	A45PBP	Pigtail, 3-wire PL-3	100
A47PB	A47PBP	Right angle pigtail, 3-wire PL-3	100
BK70BB	BK70BBP	Black steel bracket	10
A77SB	A77SBP	Gray steel bracket	20
RETAIL			
TLL22RK		Set with (2) each STL22RCB, A70GB & A47PB, clam	2

FMVSS	Red S T I; Yellow I P
MATERIALS	Polycarbonate lens and housing
VOLT/AMP	Red: 12.8VDC - .161 Stop/Turn, .009A Tail Yellow: 12.8VDC - .181 Turn, .023A Parking
WT/DIMS	.397 lbs. / 6.5" x 2.313" x 2.188"
WARRANTY	Lifetime LED Warranty

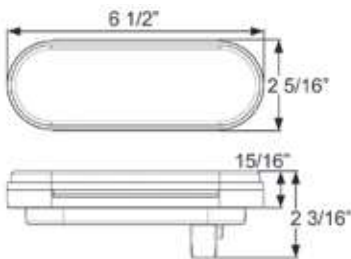

HOLE CUT-OUT:
6.85" X 2.5" (1.25" R)



TLL22RK



STL22RB



STL22CCRB



STL22RCB



STL22AB



STL22CCAB

LED SEALED STOP/TURN/TAIL & PARKING/TURN SIGNALS

HYPERX[®]



STL572RB



STL572AB

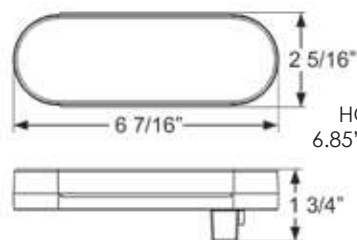

HOLE CUT-OUT:
6.85" X 2.5" (1.25" R)

STL572 SERIES

HyperX[®] 6" Oval Sealed LED Lights

- Sonically sealed, waterproof
- Accepts standard PL-3 plugs

BULK P/N	POLYPACK P/N	DESCRIPTION	QTY
RED STOP/TURN/TAIL - 12 DIODES			
STL572RB	STL572RBP	PL-3 connection	10
YELLOW PARKING/TURN SIGNAL - 12 DIODES			
STL572AB	STL572ABP	PL-3 connection	10

FMVSS	Red S T I; Yellow I P
MATERIALS	Polycarbonate lens and housing
VOLT/AMP	Red: 12.8VDC - .174 Stop/Turn, .007A Tail Yellow: 12.8VDC - .261 Turn, .013A Parking
WT/DIMS	.331 lb. / 6.438" x 2.313" x 1.75"
WARRANTY	Lifetime LED Warranty

Optronics LED



STL70RB



STL70AB

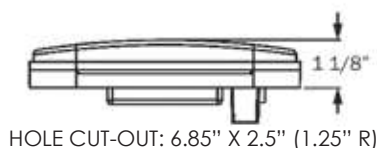
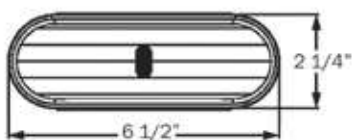

HOLE CUT-OUT: 6.85" X 2.5" (1.25" R)

STL70 SERIES

High Diode Count 6" Oval Sealed LED Lights

- Sonically sealed, waterproof
- 48-56 LEDs for high diode count appearance
- Accepts standard PL-3 plugs



BULK P/N	POLYPACK P/N	DESCRIPTION	QTY
RED STOP/TURN/TAIL - 48 DIODES			
STL70RB	STL70RBP	PL-3 connection	10
YELLOW PARKING/TURN SIGNAL - 56 DIODES			
STL70AB	STL70ABP	PL-3 connection	10

FMVSS	Red S T I P2; Yellow I P2 P
MATERIALS	Polycarbonate lens and housing
VOLT/AMP	Red: 12.8VDC - .362 Stop/Turn, .013A Tail Yellow: 12.8VDC - .400 Turn, .046A Parking
WT/DIMS	.353 lbs. / 6.5" x 2.25" x 1.125"
WARRANTY	Lifetime LED Warranty

STL572 & STL70 ACCESSORIES			
A70GB	A70GBP	Grommet	50
A45PB	A45PBP	Pigtail, 3-wire PL-3	100
A47PB	A47PBP	Right angle pigtail, 3-wire PL-3	100
BK70BB	BK70BBP	Black steel bracket	10
A77SB	A77SBP	Gray steel bracket	20

STL175 SERIES

GloLight® 6" Oval Sealed LED E Rated Mid-Ship Turn Signal and Intermediate Marker Light

GloLight®

PATENTED TECHNOLOGY

- Sonically sealed, waterproof
- SAE "E" compliant—meets California requirements for mid-ship turn signal on vehicles 30 feet or longer
- Weathertight connection standard

BULK P/N	POLYPACK P/N	DESCRIPTION	QTY
E RATED - 10 DIODES			
STL175AMFB	STL175AMFBP	Weathertight connection	10
ACCESSORIES			
A45PMB	A45PMBP	Weathertight pigtail	100
AL45PWTB	AL45PWTBP	Weathertight to PL-3 adaptor	50
BK70BB	BK70BBP	Black steel bracket	10
A77SB	A77SBP	Gray steel bracket	20
A7TRSSB	A7TRSSBP	Stainless steel flange cover	20

FMVSS	E P2
MATERIALS	Polycarbonate lens and housing
VOLT/AMP	12.8VDC - .201A Turn, .054 Marker
WT/DIMS	Grommet Mount: .309 lbs. / 6.5" x 2.375" x 2.5" Flange Mount: .309 lbs. / 7.875" x 3.313" x 2.5"
WARRANTY	Lifetime LED Warranty



Marker



Turn

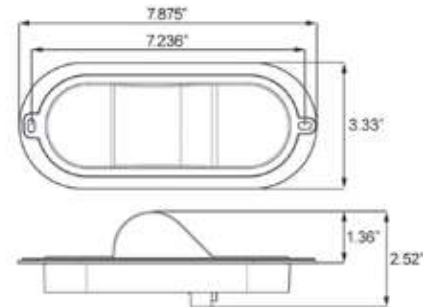

LED SEALED STOP/TURN/TAIL & PARKING/TURN SIGNALS



STL71/75 SERIES 6" Oval Sealed LED E Rated Mid-Ship Turn Signal and Intermediate Marker Light

- Sonically sealed, waterproof
- SAE "E" compliant—meets California requirements for mid-ship turn signal on vehicles 30 feet or longer
- Weathertight connection standard



STL71AMB

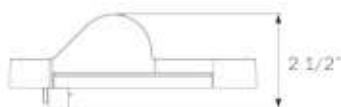
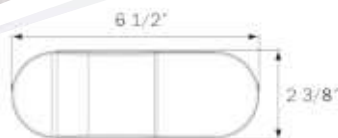

HOLE CUT-OUT: 6.85" X 2.5" (1.25" R)



STL75AMFB

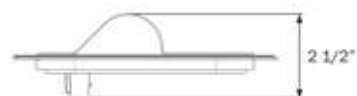
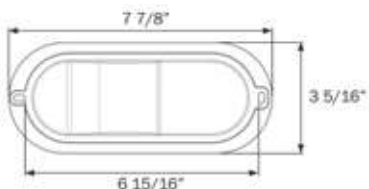

HOLE CUT-OUT: 6.85" X 2.5" (1.25" R)

BULK P/N	POLYPACK P/N	DESCRIPTION	QTY
E RATED - 10 DIODES			
STL71AMB	STL71AMBP	Weathertight connection	10
STL75AMFB	STL75AMFBP	Flange, weathertight connection	10
ACCESSORIES			
A70GB	A70GBP	Grommet	50
A45PMB	A45PMBP	Weathertight pigtail	100
AL45PWTB	AL45PWTBP	Weathertight to PL-3 adaptor	50
BK70BB	BK70BBP	Black steel bracket	10
A77SB	A77SBP	Gray steel bracket	20
A7TRSSB	A7TRSSBP	Stainless steel flange cover	20

FMVSS E P2

MATERIALS Polycarbonate lens and housing

VOLT/AMP 12.8VDC - .201A Turn, .054 Marker

WT/DIMS Grommet Mount: .309 lbs. / 6.5" x 2.375" x 2.5"

Flange Mount: .309 lbs. / 7.875" x 3.313" x 2.5"

WARRANTY Lifetime LED Warranty

STL75 SERIES

6" Oval Sealed LED E2 Rated Mid-Ship Turn Signal and Intermediate Marker Light



- Sonically sealed, waterproof
- "E2" rated for vehicles less than 30 feet in length
- Available with standard PL-3 or optional weathertight connection



STL75AB

BULK P/N	POLYPACK P/N	DESCRIPTION	QTY
E2 RATED - 9 DIODES			
STL75AB	STL75ABP	PL-3 connection	10
STL75AMB	STL75AMB	Weathertight connection	10
ACCESSORIES			
A70GB	A70GBP	Grommet	50
A45PB	A45PBP	Pigtail, 3-wire PL-3	100
A47PB	A47PBP	Right angle pigtail, 3-wire PL-3	100
A45PMB	A45PMBP	Weathertight pigtail	100
AL45PWTB	AL45PWTBP	Weathertight to PL-3 adaptor	50
BK70BB	BK70BBP	Black steel bracket	10
A77SB	A77SBP	Gray steel bracket	20

FMVSS	A E2 P2
MATERIALS	Polycarbonate lens and housing
VOLT/AMP	12.8VDC - .141A Turn, .060 Marker
WT/DIMS	PL-3 Connection: .309 lbs. / 6.5" x 2.313" x 2.75" Weathertight: .309 lbs. / 6.5" x 2.313" x 2.58"
WARRANTY	Lifetime LED Warranty

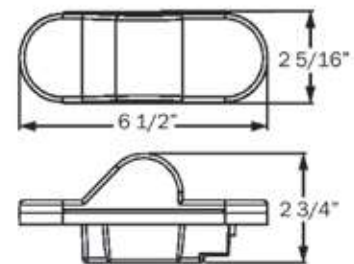

HOLE CUT-OUT: 6.85" X 2.5" (1.25" R)

LED SEALED STOP/TURN/TAIL & PARKING/TURN SIGNALS

GloLight®

STL133 SERIES GloLight® Sealed Rectangular LED Stop/Turn/Tail Lights

STOP/TURN



TAIL LIGHT



PATENTED TECHNOLOGY

- Sonically sealed, waterproof
- Accepts standard PL-3 plugs

BULK P/N	POLYPACK P/N	DESCRIPTION	QTY
RED STOP/TURN/TAILO - 14 DIODES			
STL133RB	STL133RBP	Grommet mount, PL-3 connection	10
ACCESSORIES			
A33GB	A33GBP	Grommet	50
A45PB	A45PBP	Pigtail, 3-wire PL-3	100
A47PB	A47PBP	Right angle pigtail, 3-wire PL-3	100

FMVSS	S2 T2 I6
MATERIALS	Polycarbonate lens and housing
VOLT/AMP	12.8VDC - .278A Stop/Turn, .135A Tail
WT/DIMS	.309 lbs. / 5.313" x 3.438" x 1.813"
WARRANTY	Lifetime LED Warranty

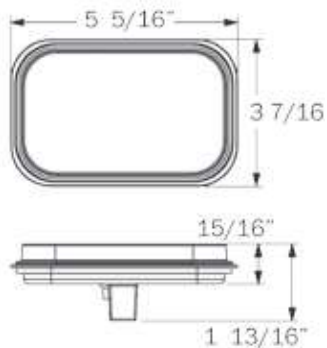

STL133RB

STL33 SERIES Sealed Rectangular LED Stop/Turn/Tail Lights

- Sonically sealed, waterproof
- Accepts standard PL-3 plugs
- Available in grommet mount and flange mount models
- Flange mount model is hard wired, with female PL-3 plug

BULK P/N	POLYPACK P/N	DESCRIPTION	QTY
RED STOP/TURN/TAIL - 12 DIODES			
STL33RB	STL33RBP	Grommet mount, PL-3 connection	10
STL34RB	STL34RBP	Kit: STL33RB, A33GB & A45PB	10
STL33RFB	STL33RFBP	Flange mount, hard wired, PL-3 plug	10
ACCESSORIES			
A33GB	A33GBP	Grommet	50
A45PB	A45PBP	Pigtail, 3-wire PL-3	100
A47PB	A47PBP	Right angle pigtail, 3-wire PL-3	100

FMVSS	S2 T2 I6
MATERIALS	Polycarbonate lens and housing
VOLT/AMP	12.8VDC - .405 Stop/Turn, .038A Tail
WT/DIMS	STL33RB: .309 lbs. / 5.313" x 3.438" x 1.938" STL33RFB: .287 lbs. / 6.125" x 4.25" x .875"
WARRANTY	Lifetime LED Warranty



STL33RB



STL33RFB

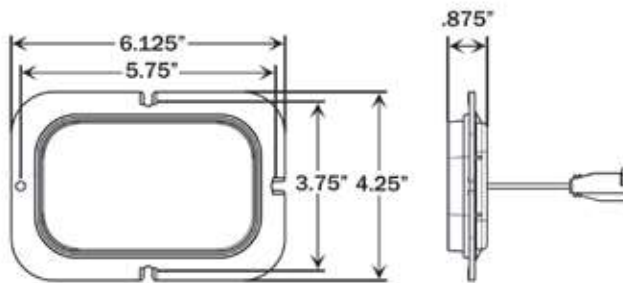

STL33RFB

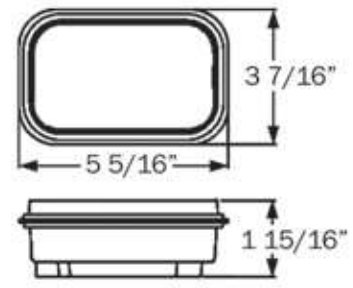

STL33RB

HOLE CUT-OUT: 5.453" X 3.578" (1" R)

LED SEALED STOP/TURN/TAIL & PARKING/TURN SIGNALS



STL35 SERIES Sealed Rectangular LED Lights

- Sonically sealed, waterproof
- Accepts standard PL-3 plugs
- Available in red and amber
- Miro-Flex™ combines smooth lens and faceted reflector design for a contemporary automotive appearance



STL35RB



STL35AB

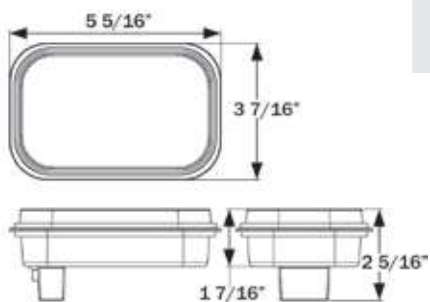

HOLE CUT-OUT: 5.453" X 3.578" (1" R)

BULK P/N	POLYPACK P/N	DESCRIPTION	QTY
RED STOP/TURN/TAIL - 16 DIODES			
STL35RB	STL35RBP	PL-3 connection	10
YELLOW PARKING/TURN SIGNAL - 16 DIODES			
STL35AB	STL35ABP	PL-3 connection	10
ACCESSORIES			
A33GB	A33GBP	Grommet	50
A45PB	A45PBP	Pigtail, 3-wire PL-3	100
A47PB	A47PBP	Right angle pigtail, 3-wire PL-3	100

FMVSS	STL35RB:	S2 T2 I6
	STL35AB:	I6 P
MATERIALS	Polycarbonate lens and housing	
VOLT/AMP	STL35RB:	12.8VDC - .301 Stop/Turn, .020A Tail
	STL35AB:	12.8VDC - .301 Turn, .020A Parking
WT/DIMS	.309 lbs. / 5.313" x 3.438" x 2.313"	
WARRANTY	Lifetime LED Warranty	

STL63 SERIES Thinline LED Stop/Turn/Tail Lights



- Sonically sealed, waterproof
- Low profile design—only 5/8" thick
- Surface mount on 14-1/8" centers
- Hard wired with separate ground wire
- Available with tinted or clear lens



STL63RB



STL63CRB

BULK P/N	POLYPACK P/N	DESCRIPTION	QTY
RED STOP/TURN/TAIL LIGHTS - 9 DIODES			
STL63RB	STL63RBP	Red	10
STL63CRB	STL63CRBP	Clear lens, red diodes	10

FMVSS	S T I
MATERIALS	Polycarbonate lens and housing
VOLT/AMP	12.8VDC - .350 Stop/Turn, .022A Tail
WT/DIMS	.275 lbs. / 15" x 1.625" x .75"
WARRANTY	Lifetime LED Warranty

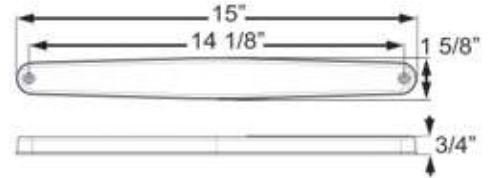

LED COMBINATION
TAIL LIGHTS & KITS



STL69RB



STL69RCB



STL69RRXB

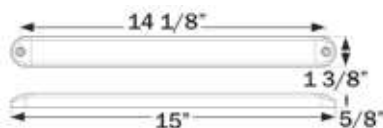

STL69RB/RCB

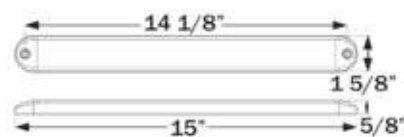

STL69RRXB



A69CB

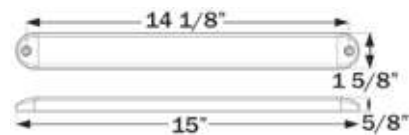

A69RXC

STL69 SERIES Thinline Sealed LED Stop/Turn/Tail Lights

- Sonically sealed, waterproof
- Low profile design—only 5/8" thick
- Surface mount on 14-1/8" centers; optional gasket
- STL69RRXB meets SAE S2T2I6 for over 80" wide vehicles and has built-in reflex meeting SAE A
- Hard wired with separate ground wire; available with optional molded plugs

BULK P/N	POLYPACK P/N	DESCRIPTION	QTY
RED STOP/TURN/TAIL LIGHTS - 11 DIODES			
STL69RB	STL69RBP	Red	10
STL69RCB	STL69RCBP	Clear lens, red diodes	10
STL69CRPG	STL69CRPGP	Clear lens, red diodes, .180 male bullets	10
STL69RCBMCV2B	STL69RCBMCV2BP	Clear lens, red diodes, 3-way female plug, A69CB base	10
STL69RRXB	STL69RRXBP	Built-in reflex	10
ACCESSORIES			
A69GB	A69GBP	Gasket	10
A69CB	A69CBP	Chrome base for STL69	10
A69RXC	A69RXCBP	Chrome base for STL69RRXB	10
RETAIL			
STL69RS		Light only, clam	6
STL69RK		STL69RB with A69CB, clam	6
STL69RRXCS		STL69RRXB with A69RXC, clam	6

FMVSS	STL69:	S T I
	STL69RRXB:	S2 T2 I6 A
MATERIALS	Polycarbonate lens and housing	
VOLT/AMP	STL69:	.350A Stop, .022 Tail
	STL69RRXB:	.161A Stop, .013A Tail
WT/DIMS	STL69:	.441 lbs. / 15" x 1.375" x .625"
	STL69RRXB:	.445 lbs. / 15" x 1.625" x .625"
WARRANTY	Lifetime LED Warranty	

STL179 SERIES GloLight® Streamline LED Light



LED COMBINATION
TAIL LIGHTS & KITS

PATENTED TECHNOLOGY

- Sonically sealed, waterproof
- Low profile design—only 1-3/8" high x 1" thick
- Surface mount on 16-1/8" centers
- Hard wired with separate ground wire

TAIL LIGHT



STOP/TURN



STL179RB

BULK P/N	POLYPACK P/N	DESCRIPTION	QTY
RED STOP/TURN/TAIL - 28 DIODES			
STL179RB	STL179RBP	Stop/turn/tail light	10
ACCESSORIES			
A79CB	A79CBP	Chrome mounting base	10



A79CB

FMVSS	ST I
MATERIALS	Polycarbonate lens and housing
VOLT/AMP	12.8VDC - .634 Stop/Turn, .445A Tail
WT/DIMS	.353 lbs. / 17" x 1.375" x 1"
WARRANTY	Lifetime LED Warranty

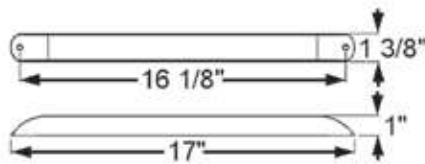

STL179RB

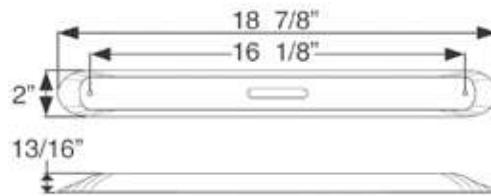

A79CB



STL79 SERIES Streamline Sealed LED Lights

- Sonically sealed, waterproof
- Low profile design—only 1-3/8" high x 1" thick
- Surface mount on 16-1/8" centers
- Available as stop/turn/tail lights and third brake lights
- Hard wired with separate ground wire



STL79RB/80RB



STL89RCB

BULK P/N	POLYPACK P/N	DESCRIPTION	QTY
RED STOP/TURN/TAIL - 11 DIODES			
STL79RB	STL79RBP	Stop/turn/tail light	10
STL80RB	STL80RBP	Third brake light	10
STL89RCB	STL89RCBP	Clear lens stop/turn/tail light	10
ACCESSORIES			
A79CB	A79CBP	Chrome mounting base	10
RETAIL			
STL79RS		Stop/turn/tail light, clam	6

FMVSS	STL79/89: S T I STL80: U
MATERIALS	Polycarbonate lens and housing
VOLT/AMP	STL79/89: 12.8VDC - .350 Stop/Turn, .022A Tail STL80: 12.8VDC - .216 Stop
WT/DIMS	.353 lbs. / 17" x 1.375" x 1"
WARRANTY	Lifetime LED Warranty

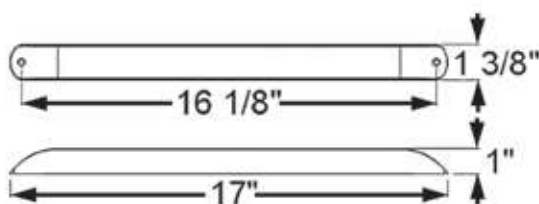

STL76 SERIES

Thinline Sealed LED Stop/Turn/Tail Light for Over 80" Wide Applications



LED COMBINATION
TAIL LIGHTS & KITS

PATENTED TECHNOLOGY

- Replaceable, snap-on red lens
- Clear lens sonically sealed to housing making light completely waterproof
- Surface mount on 12-7/8" centers
- Meets SAE S2T2I6 for over 80" wide vehicles
- Hard wired with separate ground wire



STL76RB

BULK P/N	POLYPACK P/N	DESCRIPTION	QTY
RED STOP/TURN/TAIL LIGHT - 11 DIODES			
STL76RB	STL76RBP	Stop/turn/tail light	10

FMVSS	S2 T2 I6
MATERIALS	Polycarbonate lens and housing
VOLT/AMP	12.8V / .275A Stop, .022A Tail
WT/DIMS	.529 lbs. / 13.26" x 2.13" x 1.42"
WARRANTY	Lifetime LED Warranty

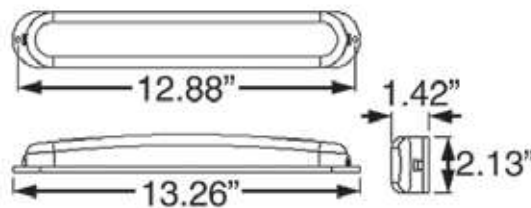



STL153 SERIES GloLight® LED Dual Face Pedestal Mount Lights

PATENTED TECHNOLOGY

- 25 LEDs per side
- Ring illuminates for tail light function; inner LEDs light and ring brightens for brake/turn
- Includes built-in 3-LED yellow side marker with reflex
- Hard wired, includes separate ground wire



BULK P/N	POLYPACK P/N	DESCRIPTION	QTY
		DUAL FACE RED YELLOW - 25 DIODES	
STL153ARDBB	STL153ARDBBP	Driver side	10
STL153ARPBB	STL153ARPBBP	Passenger side	10

FMVSS	S2 T2 I6, I6 P, A P2
MATERIALS	Chrome plastic housing, acrylic lens
VOLT/AMP	12.8V / .360A Stop, .030A Tail
WT/DIMS	1.477 lbs. / 4.688" x 4.875" x 2.438"
WARRANTY	Lifetime LED Warranty

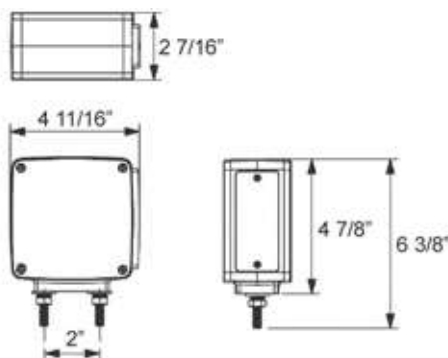

STL52/53 SERIES LED Pedestal Mount Lights



- Lead wires exit through mounting post; separate ground wire
- 21 LEDs per side
- STL53 available in driver and passenger side models with built-in yellow side marker with reflex



STL52ARB



STL52ARB profile

BULK P/N	POLYPACK P/N	DESCRIPTION	QTY
		DUAL FACE RED YELLOW - 42 DIODES	
STL52ARB	STL52ARBP	Round	10
STL53ARPB	STL53ARBPB	Square, passenger side	10
STL53ARDB	STL53ARDBP	Square, driver side	10

FMVSS	STL52ARB: S T I P
	STL53: Tail S T I P, Side Marker A P2
MATERIALS	STL52: Die cast housing, polycarbonate lens
	STL53: Polycarbonate lens and housing
VOLT/AMP	STL52ARB: 12.8VDC - .360 Stop/Turn, .030A Tail
	STL53: 12.8VDC - .750 Stop/Turn, .114A Tail
WT/DIMS	STL52: 1.477 lbs. / 4.25" x 4.25" x 1.938"
	STL53: .882 lb. / 4.5" x 4.75" x 2.25"
WARRANTY	Lifetime LED Warranty



STL53ARPB

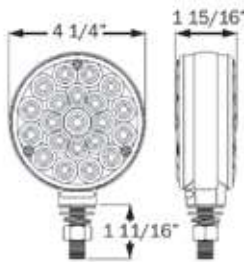

STL52ARB

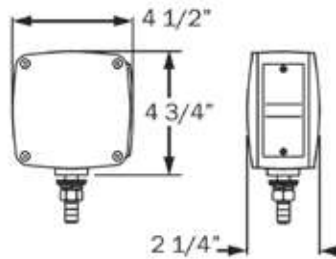

STL53ARDB/ARPB



STL190 SERIES GloLight® 7" LED Transit Lights

PATENTED TECHNOLOGY

- Sonically sealed, waterproof
- Surface mount light with mounting gasket
- Hard wired with separate ground wire



STOP/
TURN

STL190RB



TAIL
LIGHT



TURN

STL190AB

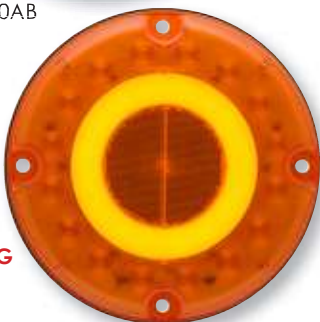

PARKING

BULK P/N	POLYPACK P/N	DESCRIPTION	QTY
RED STOP/TURN/TAIL LIGHT - 32 DIODES			
STL190RB	STL190RBP	Stop/turn/tail light	5
YELLOW PARKING/TURN SIGNAL - 32 DIODES			
STL190AB	STL190ABP	Parking/turn signal	5

FMVSS	Red S2 I6 T2 P2 A; Yellow I6 P2 A
MATERIALS	Polycarbonate lens and housing
VOLT/AMP	Red: 12.8VDC - .340A Stop/Turn, .135A Tail Yellow: 12.8VDC - .410A Turn, .072A Parking
WT/DIMS	.970 lb. / 7" x 7" x 1.625"
WARRANTY	Lifetime LED Warranty

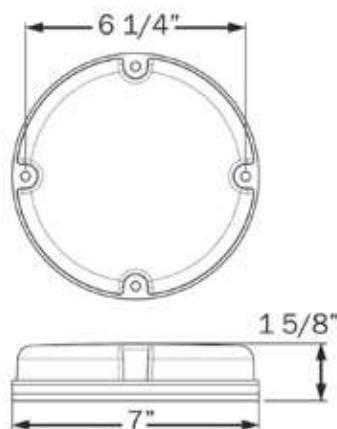

STL90 SERIES 7" Round LED Transit Lights

- Sonically sealed, waterproof
- Surface mount light with mounting gasket
- Hard wired with separate ground wire
- Available in 12V and 12-24V models



LED COMBINATION
TAIL LIGHTS & KITS

BULK P/N	POLYPACK P/N	DESCRIPTION	QTY
RED STOP/TURN/TAIL LIGHT - 31 DIODES			
STL90RB	STL90RBP	Stop/turn/tail light, 12V	5
STL90R24B	STL90R24BP	Stop/turn/tail light, 12-24V	5
YELLOW TURN SIGNAL - 31 DIODES			
STL90AB	STL90ABP	Parking/turn signal, 12V	5
STL90A24B	STL90A24BP	Parking/turn signal, 12-24V	5

FMVSS	Red S2 I6 T2 P2 A; Yellow I6 P2 A
MATERIALS	Polycarbonate lens and housing
VOLT/AMP	Red: 12.8VDC - .243A Stop/Turn, .046A Tail Yellow: 12.8VDC - .275A Turn, .042A Parking
WT/DIMS	.970 lb. / 7" x 7" x 1.438"
WARRANTY	Lifetime LED Warranty

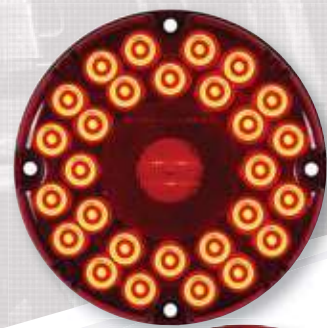
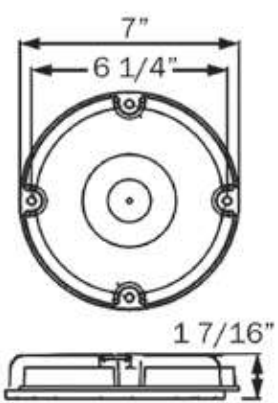

STL90RB



STL90AB

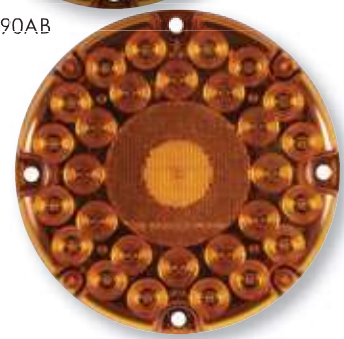

GloLight[®]

STL161 SERIES

GloLight[®] LED Combination Tail Lights



TAIL LIGHT



STOP/TURN/BACK-UP



STL161RB

PATENTED TECHNOLOGY

- Stud mount stop/turn/tail light with built-in back-up light and reflex
- 30-LED tail light; 6-LED back-up light
- Driver side light also includes 3-LED license light
- Hard wired; wire exits through back of housing
- Includes ground wire

BULK P/N	POLYPACK P/N	DESCRIPTION	QTY
GLOLIGHT[®] COMBINATION TAIL LIGHTS - 36 DIODES			
STL161RB	STL161RBP	Passenger side, 30-LED tail, 6-LED back-up	5
STL161RLB	STL161RLBP	Driver side with 3-LED license light	5

FMVSS	STL161RB: A 16 (2)R S2 (3)T STL161RLB: A 16 (2)R S2 (3)T L
MATERIALS	Acrylic lens, plastic housing
VOLT/AMP	12.8VDC - Tail .19A, Stop/Turn .30A, Back-up .21A
WT/DIMS	.882 lb. / 5.813" x 6.75" x 2.688"
WARRANTY	Lifetime LED Warranty

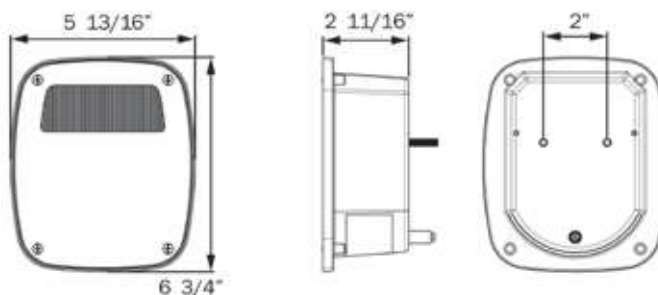

STL60/61 SERIES LED Combination Tail Lights

- Stud mount stop/turn/tail lights with built-in back-up light and reflex
- Choose from Optronics® LED 52-diode and FLEET Count™ 15-diode tail lights
- Hard wired; wire exits through back of housing
- Includes ground wire



STL60RB

BULK P/N	POLYPACK P/N	DESCRIPTION	QTY
OPTRONICS® COMBINATION TAIL LIGHTS - 52 DIODES			
STL60RB	STL60RBP	Passenger side, 16-LED tail, 36-LED back-up	5
STL60RLB	STL60RLBP	Driver side with 5-LED license light	5
FLEET COUNT™ COMBINATION TAIL LIGHTS - 15 DIODES			
STL61RB	STL61RBP	Passenger side, 9-LED tail, 6-LED back-up	5
STL61RLB	STL61RLBP	Driver side with 3-LED license light	5



STL61RB

FMVSS	STL61RB:	A 16 (2)R S2 (3)T
	STL61RLB:	A 16 (2)R S2 (3)T L
MATERIALS	Acrylic lens, plastic housing	
VOLT/AMP	12.8VDC - Tail .015A, Stop/Turn .308A, Back-up .328A	
WT/DIMS	.882 lb. / 5.813" x 6.75" x 2.688"	
WARRANTY	Lifetime LED Warranty	

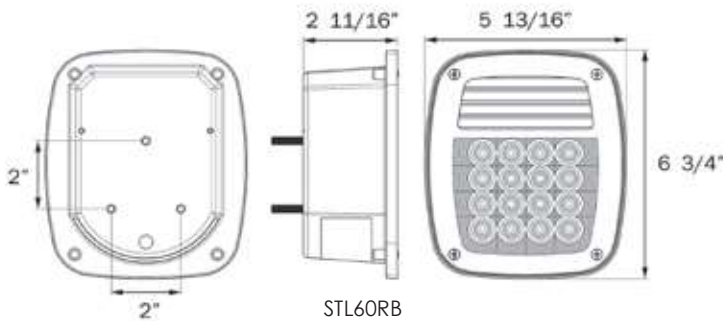

STL60RB

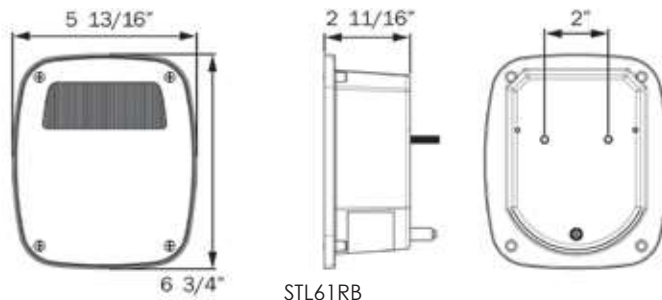

STL61RB



STL108/109 SERIES GloLight® LED Combination Tail Lights

PATENTED TECHNOLOGY

- Traditional style fits many applications
- Stud mount lights mount on 2" centers
- Hard wired, with separate ground wire



TAIL LIGHT



STOP/TURN

STL108/109RB



TLL190RK

BULK P/N	POLYPACK P/N	DESCRIPTION	QTY
COMBINATION TAIL LIGHTS - 25 DIODES			
STL108RB	STL108RBP	Passenger side	10
STL109RB	STL109RBP	Driver side, 3-LED license light	10
RETAIL			
TLL190RK	Set: STL108RB, STL109RB, mounting hardware; Try Me package, clam		2

FMVSS	Stop/Tail A I S T, Side Marker A P2, License L
MATERIALS	Acrylic lens, ABS housing
VOLT/AMP	12.8VDC - Stop/Turn .310A, Marker .230A
WT/DIMS	.970 lb. / 5.031" x 4.563" x 2.625"
WARRANTY	Lifetime LED Warranty

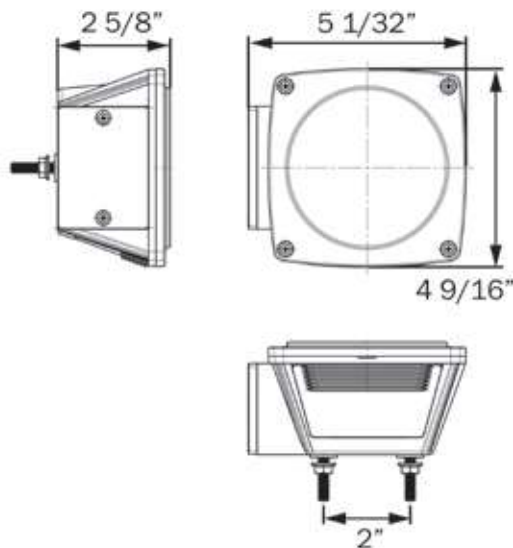

STL8/9 SERIES LED Combination Tail Lights

- Traditional style fits many applications
- Stud mount lights mount on 2" centers
- Hard wired, with separate ground wire

BULK P/N	POLYPACK P/N	DESCRIPTION	QTY
COMBINATION TAIL LIGHTS - 11 DIODES			
STL8RB	STL8RBP	Passenger side	10
STL8R3B	STL8R3BP	Passenger side, female PL-3 plug	10
STL9RB	STL9RBP	Driver side, 3-LED license light	10
STL9R3B	STL9R3BP	Driver side, 3-LED license light, female PL-3 plug	10
RETAIL			
STL6RS	Passenger side		6
STL7RS	Driver side with 3-LED license light		6
TLL9RK	Kit: STL8RB, STL9RB, 25-ft harness, license plate bracket, mounting hardware; clam		2
TLL90RK	Set: STL8RB, STL9RB, mounting hardware; clam		2

FMVSS Stop/Tail A I S T, Side Marker A P2, License L

MATERIALS Acrylic lens and plastic housing

VOLT/AMP 12.8VDC - Stop/Turn .259A, Marker .062A

WT/DIMS .970 lb. / 5.25" x 4.75" x 2.688"

WARRANTY Lifetime LED Warranty



STL8/9RB
STL6/7RS



TLL9RK

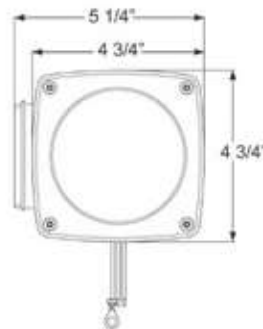

TLL90RK



STL2/3RB

STL2/3 SERIES

LED Combination Tail Lights for Over 80" Applications

- Designed for over 80" wide applications
- Stud mount lights mount on 2" centers
- Hard wired, with separate ground wire

BULK P/N	POLYPACK P/N	DESCRIPTION	QTY
OVER 80 COMBINATION TAIL LIGHTS - 18 DIODES			
STL2RB	STL2RBP	Passenger side	10
STL3RB	STL3RBP	Driver side, license light	10

FMVSS	Stop/Tail A(3) I(3) S(3) T, Side Marker A P2, License L
MATERIALS	Acrylic lens and plastic housing
VOLT/AMP	12.8VDC - Stop/Turn .268A, Marker .059A
WT/DIMS	.970 lb. / 6.25" x 4.75" x 2.688"
WARRANTY	Lifetime LED Warranty

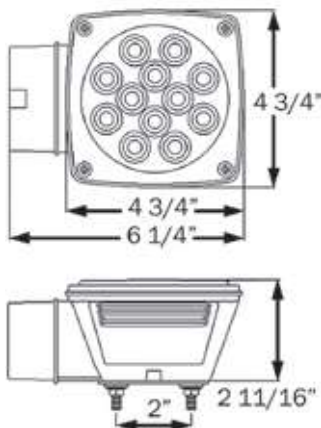

STL008/009 SERIES ONE™ LED Combination Tail Lights

- Sealed, waterproof design
- Traditional style fits many applications
- Stud mount lights mount on 2" centers
- Hard wired with separate ground wire

ONE™
LED LAMPS

LED COMBINATION
TAIL LIGHTS & KITS

BULK P/N	POLYPACK P/N	DESCRIPTION	QTY
COMBINATION TAIL LIGHTS - 1 DIODE			
STL008RB	STL008RBP	Passenger side	10
STL009RB	STL009RBP	Driver side	10
STL008RPG	STL008RPGP	Passenger side, .180 bullets	10
STL009RPG	STL009RPGP	Driver side, .180 bullets	10
RETAIL			
STL008RS	Passenger side		6
STL009RS	Driver side with 3-LED license light		6
TLL008RK	Set: STL008RB, STL009RB, mounting hardware, clam		2



STL008RB



STL009RB

FMVSS	S T A. P2 A, L
MATERIALS	Acrylic lens and plastic housing
VOLT/AMP	12.8VDC - Stop/Turn .25A, Marker .062A
WT/DIMS	.970 lb. / 5.063" x 4.563" x 2.875"
WARRANTY	Lifetime LED Warranty



TLL008RK

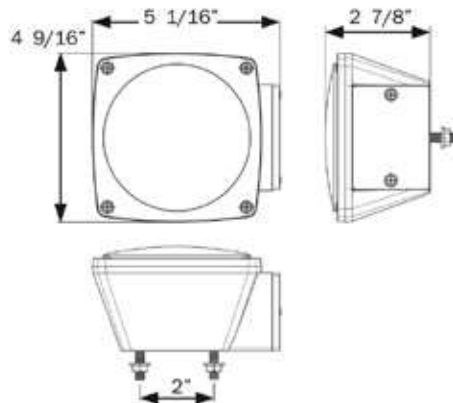



STL28/29 SERIES Miro-Flex™ LED Combination Tail Lights

- Universal design fits many applications
- Stud mount lights mount on 2" centers
- Hard wired with separate ground wire
- STL28 is 6-function: stop, turn, tail, rear reflex, side marker and side reflex
- STL29 is 7-function: above plus license illuminator



STL29RB



STL28RB



TLL29RK

BULK P/N	POLYPACK P/N	DESCRIPTION	QTY
COMBINATION TAIL LIGHTS - 15 DIODES			
STL28RB	STL28RBP	Passenger side	10
STL29RB	STL29RBP	Driver side, with 5-LED license light	10
RETAIL			
TLL28RK	Set: STL28RB, STL29RB, mounting hardware; clam		2
TLL29RK	Kit: STL28RB, STL29RB, 25-ft harness, license plate bracket, mounting hardware; clam		2

FMVSS	STL28:	Stop/Tail A I S T, Side Marker A P2
	STL29:	Stop/Tail A I S T, Side Marker A P2, License L
MATERIALS	Acrylic lens and plastic housing	
VOLT/AMP	STL28:	12.8VDC - .174A Stop/Turn, .054A Marker
	STL29:	12.8VDC - .174A Stop/Turn, .054A Marker
WT/DIMS	.750 lb. / 5.25" x 5" x 2.625"	
WARRANTY	Lifetime LED Warranty	

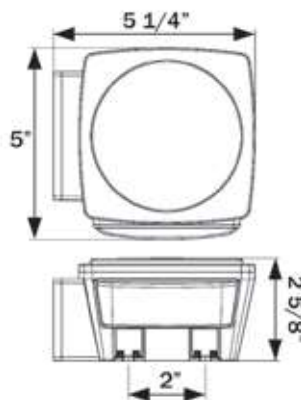

STL116/117 SERIES GloLight® LED Low Profile Combination Tail Lights

- Designed for marine trailer application
- Sealed, waterproof construction
- Universal mount
- Hard wired, with separate ground wire

PATENTED
TECHNOLOGY

GloLight®



TAIL LIGHT

STL116RB



STOP/TURN

STL117RB

BULK P/N	POLYPACK P/N	DESCRIPTION	QTY
COMBINATION TAIL LIGHTS - 28 DIODES			
STL116RB	STL116RBP	Passenger side	10
STL117RB	STL117RBP	Driver side, with 6-LED license light	10
RETAIL			
TLL170RK	Set: STL116RB, STL117RB, mounting hardware, Try Me package		2

FMVSS	STL116: A I S T, P2 A ; STL117: A I S T, P2 A, L
MATERIALS	Acrylic lens and plastic housing
VOLT/AMP	12.8VDC - Stop/Turn .252A, Marker .135A
WT/DIMS	.816 lb. / 8" x 2.9" x 2.6"
WARRANTY	Lifetime LED Warranty



TLL170RK

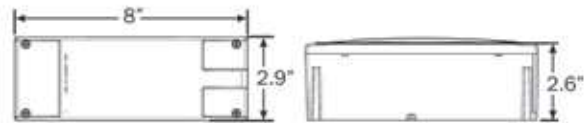

STL14/15 SERIES FLEET Count™ LED Low Profile Combination Tail Lights

- Designed for marine trailer application
- Sealed, waterproof construction
- Universal mount
- Hard wired, with separate ground wire

FLEET COUNT



STL14/15RB

BULK P/N	POLYPACK P/N	DESCRIPTION	QTY
COMBINATION TAIL LIGHTS - 12 DIODES			
STL14RB	STL14RBP	Passenger side	10
STL15RB	STL15RBP	Driver side, with 6-LED license light	10

FMVSS	STL14: A I S T, P2 A ; STL15: A I S T, P2 A, L
MATERIALS	Acrylic lens and plastic housing
VOLT/AMP	12.8VDC - Stop/Turn .252A, Marker .135A
WT/DIMS	.816 lb. / 8" x 2.875" x 2.813"
WARRANTY	Lifetime LED Warranty

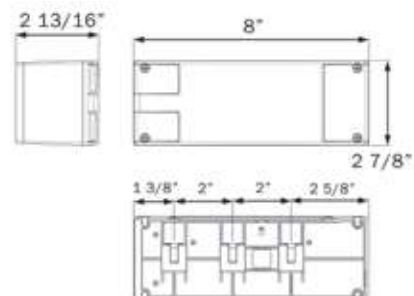



STL17RB



STL16NTRB



TLL16RK



STL16/17 SERIES LED Combination Tail Lights

- Designed for marine trailer application
- Sealed, waterproof construction
- Universal mount
- Hard wired, with separate ground wire
- STL16/17NTRB feature light tube technology and SMD LED

BULK P/N	POLYPACK P/N	DESCRIPTION	QTY
COMBINATION TAIL LIGHTS - 18 DIODES			
STL16RB	STL16RBP	Passenger side	10
STL17RB	STL17RBP	Driver side, with 4-LED license light	10
STL16NTRB	STL16NTRB	Passenger side, SMD LED	10
STL17NTRB	STL17NTRB	Driver side, SMD LED with 4-LED license light	10
ACCESSORIES			
AL16RB	AL16RBP	Tail light lens	50
AL17RB	AL17RBP	Side marker lens	50
RETAIL			
STL16RS	Passenger side, stainless hardware		6
STL17RS	Driver side with 4-LED license light, stainless hardware		6
TLL160RK	Set: STL16RB, STL17RB, mounting hardware; clam		2
TLL16RK	Kit: STL16RB, STL17RB, 25-ft harness, license plate bracket, stainless steel mounting hardware; clam		2

FMVSS	STL16: Stop/Tail A I S T P2 PC, Side Marker A P2 STL17: Stop/Tail A I S T P2 PC, Side Marker A P2, License L
MATERIALS	Acrylic lens and plastic housing
VOLT/AMP	STL16: 12.8VDC - .259A Stop/Turn, .062A Marker STL17: 12.8VDC - .268A Stop/Turn, .059A Marker
WT/DIMS	.816 lb. / 8.063" x 2.875" x 2.813"
WARRANTY	Lifetime LED Warranty

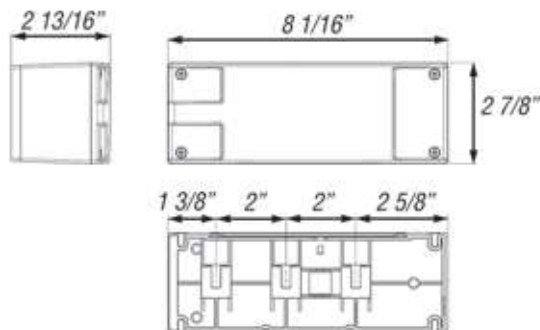

STL0016/0017 SERIES ONE™ LED Combination Tail Lights

ONE™
LED LAMPS

- Designed for marine trailer application
- Sealed, waterproof construction
- Universal mount
- Hard wired, with separate ground wire



STL0016RB



STL0017RB

BULK P/N	POLYPACK P/N	DESCRIPTION	QTY
COMBINATION TAIL LIGHTS			
STL0016RB	STL0016RBP	Passenger side	10
STL0017RB	STL0017RBP	Driver side, with license light	10
RETAIL			
STL0016RS	Passenger side, clam		6
STL0017RS	Driver side with 4-LED license light, clam		6
TLL0016RK	Set: STL0016RB, STL0017RB, mounting hardware, clam		2

FMVSS STL0016: Stop/Tail A I S T P2, Side Marker A P2
STL0017: Stop/Tail A I S T P2, Side Marker A P2, License L

MATERIALS Acrylic lens and plastic housing

VOLT/AMP STL0016: 12.8VDC - .31A Stop/Turn, .12A Marker
STL0017: 12.8VDC - .32A Stop/Turn, .26A Marker

WT/DIMS .816 lb. / 8.0" x 2.9" x 2.6"

WARRANTY Lifetime LED Warranty

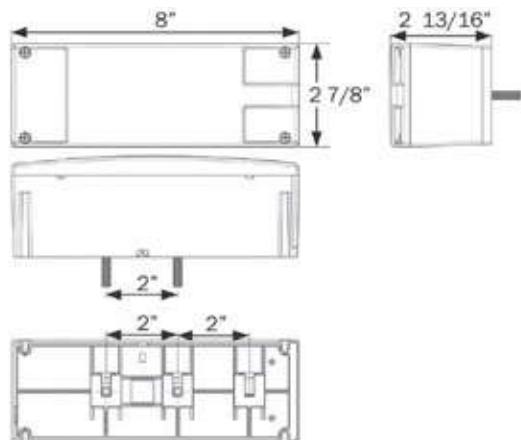

TLL0016RK

LED COMBINATION
TAIL LIGHTS & KITS



STL26/27 SERIES Miro-Flex™ LED Combination Tail Lights



STL26RB



STL27RB

- Designed for marine trailer application
- Sealed, waterproof construction
- Universal mount
- Hard wired, with separate ground wire

BULK P/N	POLYPACK P/N	DESCRIPTION	QTY
COMBINATION TAIL LIGHTS - 14 DIODES			
STL26RB	STL26RBP	Passenger side	10
STL27RB	STL27RBP	Driver side with 4-LED license light	10
RETAIL			
TLL26RK	Set: STL26RB, STL27RB, mounting hardware; clam		2



TLL26RK

FMVSS	STL26: A 16 S2 (3)T PC STL27: A 16 S2 (3)T PC L
MATERIALS	Acrylic lens and plastic housing
VOLT/AMP	STL26: 12.8VDC - .167A Stop/Turn, .054A Marker STL27: 12.8VDC - .167A Stop/Turn, .107A Marker/License
WT/DIMS	.882 lb. / 8.063" x 2.938" x 2.688"
WARRANTY	Lifetime LED Warranty

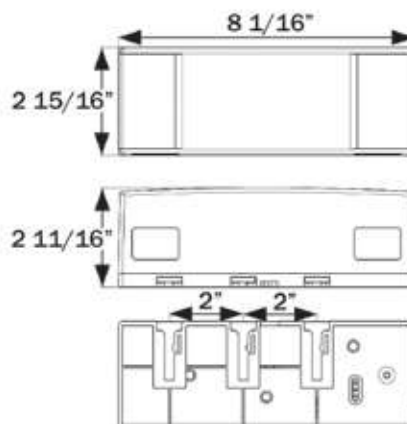

STL36/37 SERIES LED Combination Tail Lights

- Designed for marine trailer application
- Sealed, waterproof construction
- Universal mount
- Hard wired, with separate ground wire

BULK P/N	POLYPACK P/N	DESCRIPTION	QTY
COMBINATION TAIL LIGHTS - 17 DIODES			
STL36RB	STL36RBP	Passenger side	20
STL36RPG	STL36RPGP	Passenger side, dual plug and ground eyelet	20
STL37RB	STL37RBP	Driver side, 6-LED license light	20
STL37RPG	STL37RPGP	Driver side, 6-LED license light, dual plug and ground eyelet	20
RETAIL			
STL36RS	Passenger side		6
STL37RS	Driver side with 4-LED license light		6
TLL36RK	Kit: STL36RB, STL37RB, (2) MCL91AK sealed yellow marker lights with chrome bases, 25-ft harness, license plate bracket, stainless steel mounting hardware; clam		2

FMVSS	STL36: Stop/Tail A S T I P2, Side Marker A PC STL37: Stop/Tail A S T I P2, Side Marker A PC, License L
MATERIALS	Acrylic lens and plastic housing
VOLT/AMP	12.8VDC - .181A Stop/Turn, .047A Marker
WT/DIMS	.992 lb. / 7.875" x 3.25" x 2.875"
WARRANTY	Lifetime LED Warranty



STL36/37RB



TLL36RK

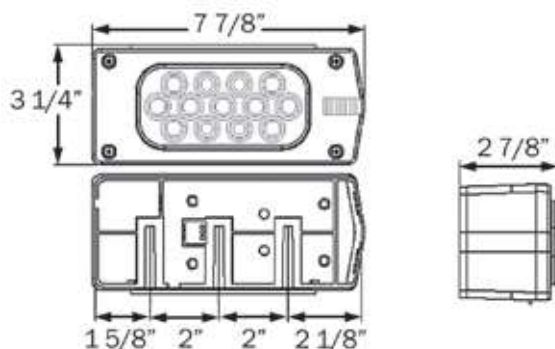



STL56/57 SERIES LED Combination Tail Lights



STL56/57RB

- Designed for marine trailer application
- Sealed, waterproof construction
- Universal mount
- Hard wired, with separate ground wire
- Stainless steel hardware

BULK P/N	POLYPACK P/N	DESCRIPTION	QTY
COMBINATION TAIL LIGHTS - 18 DIODES			
STL56RB	STL56RBP	Passenger side	10
STL57RB	STL57RBP	Driver side, 5-LED license light	10
RETAIL			
TLL56RK	Kit: STL56RB, STL57RB, 25-ft harness, license plate bracket, stainless steel mounting hardware; clam		2



TLL56RK

FMVSS	STL56: Stop/Tail A S T I P2, Side Marker A P2 STL57: Stop/Tail A S T I P2, Side Marker A P2, License L
MATERIALS	Acrylic lens and plastic housing
VOLT/AMP	STL56: 12.8VDC - .259A Stop/Turn, .062A Marker STL57: 12.8VDC - .268A Stop/Turn, .059A Marker
WT/DIMS	.816 lb. / 6.063" x 3.625" x 2.25"
WARRANTY	Lifetime LED Warranty

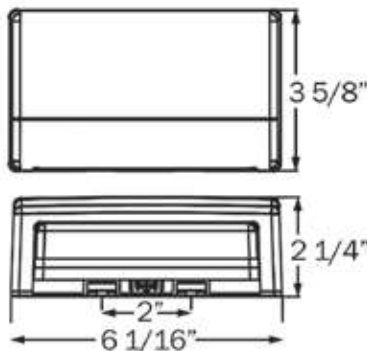

RBL10AS LED Strobe/Beacon Light

- Magnetic mount
- 12-ft. coil cord with power plug

BULK P/N	POLYPACK P/N	DESCRIPTION	QTY
RETAIL			
RBL10AS	Amber rotary beacon 12/24V, clam		2

VOLTAGE	10-30VDC
WT/DIMS	.88 lb. / 5.125" x 5.125" x 3.5"
WARRANTY	Lifetime LED Warranty



RBL10AS

RBL10CA LED Multi-Function Strobe/Beacon Light

- Sonically sealed
- Five flash patterns
- Surface mount
- Operating range 9-36VDC
- SAE J845/EMC R10 approved

BULK P/N	POLYPACK P/N	DESCRIPTION	QTY
YELLOW			
RBL10CA	-	Clear lens, amber rotary beacon	1

FMVSS	W3-1
MATERIALS	Polycarbonate
VOLT/AMP	12.8VDC - 1.04A, 36.0VDC - 0.36A
WT/DIMS	1.53 lb. / 6.377" x 6.377" x 4.173"
WARRANTY	Lifetime LED Warranty



RBL10CA

TLL21/31 SERIES LED Magnet Mount Towing Light Kits

Sonically sealed, waterproof

BULK P/N	POLYPACK P/N	DESCRIPTION	QTY
RETAIL			
TLL21RK	Towing light kit with wiring harness, clam		2
TLL31RK	Wireless magnet mount towing light kit, clam		2

FMVSS	ST I
MATERIALS	Polycarbonate
VOLT/AMP	12.8VDC - .360A Stop/Turn, .030A Tail
WT/DIMS	2 lbs. / 3.875" x 2.188" x 6"
WARRANTY	Lifetime LED Warranty



TLL21RK



BUL101 SERIES GloLight® 4" Round Sealed DOT LED Back-Up Lights

PATENTED TECHNOLOGY

- Sonically sealed, waterproof
- Certified for back-up light function when installed as pair in two-lamp system [SAE (2)R]



BUL101CB

BULK P/N	POLYPACK P/N	DESCRIPTION	QTY
CLEAR BACK-UP LIGHTS - 21 DIODES			
BUL101CB	BUL101CBP	Standard 2-pin connection	10
BUL101CKB	BUL101CKBP	Kit with A45GB and A49PB	10
ACCESSORIES			
A45GB	A45GBP	Grommet	50
A45CB	A45CBP	Pigtail, 2-wire	100
A49PB	A49PBP	Right angle pigtail, 2-wire	100
BK45BB	BK45BBP	Black steel bracket	10
A45BB	A45BBP	Black plastic flange	100
A45SB	A45SBP	Stainless steel mounting flange	20
A45CGB	A45CGBP	Chrome grommet cover	20

FMVSS	(2) R
MATERIALS	Polycarbonate lens and housing
VOLT/AMP	12.8VDC - 0.425A
WT/DIMS	.309 lbs. / 4.313" x 4.313" x 1.625"
WARRANTY	Lifetime LED Warranty

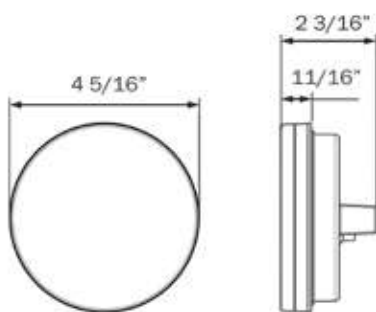

HOLE CUT-OUT: 4.5"

BUL06 SERIES FLEET Count™ 4" Round Sealed DOT LED Back-Up Lights

- Sonically sealed, waterproof
- Certified for back-up light function when installed as pair in two-lamp system [SAE (2)R]



LED DOT COMPLIANT
BACK-UP LIGHTS

BULK P/N	POLYPACK P/N	DESCRIPTION	QTY
CLEAR BACK-UP LIGHTS - 6 DIODES			
BUL06CB	BUL06CBP	Grommet mount, 2-pin connection	10
BUL06CKB	BUL06CKBP	Kit with A45GB and A49PB, 2-pin	10
BUL06CMB	BUL06CMBP	Grommet mount, weathertight connection	10
BUL06CFB	BUL06CFBP	Flange mount, 2-pin connection	10
BUL06CFMB	BUL06CFMBP	Flange mount, weathertight connection	10

ACCESSORIES			
A45GB	A45GBP	Grommet	50
A45CB	A45CBP	Pigtail, 2-wire	100
A49PB	A49PBP	Right angle pigtail, 2-wire	100
BK45BB	BK45BBP	Black steel bracket	10
A45BB	A45BBP	Black plastic flange	100
A45SB	A45SBP	Stainless steel mounting flange	20
A45CGB	A45CGBP	Chrome grommet cover	20

FMVSS	(2) R
MATERIALS	Polycarbonate lens and housing
VOLT/AMP	12.8VDC - 0.180A
WT/DIMS	Grommet mount: .309 lbs. / 4.25" x 4.25" x 1.625" Flange mount: .350 lbs. / 5.5" x 5.5" x 1.875"
WARRANTY	Lifetime LED Warranty



BUL06CB



BUL06CFB

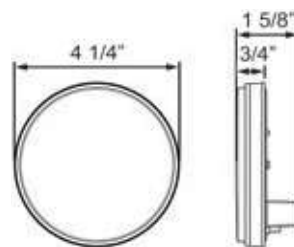

BUL06CB

HOLE CUT-OUT: 4.528"

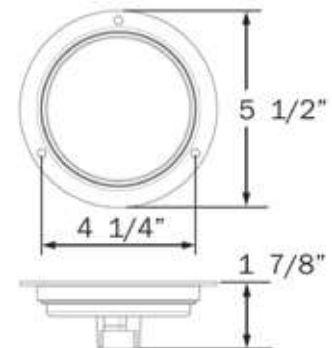

BUL06CFB

HOLE CUT-OUT: 4.579"



BUL003 SERIES ONE™ 4" Round Sealed DOT LED Back-Up Lights

- Sonically sealed, waterproof
- Certified for back-up light function when installed as pair in two-lamp system [SAE (2)R]



BUL003CB

BULK P/N	POLYPACK P/N	DESCRIPTION	QTY
CLEAR BACK-UP LIGHTS - 1 DIODE			
BUL003CB	BUL003CBP	Grommet mount, 2-pin connection	10
BUL003CKB	BUL003CKBP	Kit with A45GB grommet and A45CB pigtail	10
ACCESSORIES			
A45GB	A45GBP	Grommet	50
A45CB	A45CBP	Pigtail, 2-wire	100
A45PMB	A45PMBP	Weathertight pigtail	100
A49PB	A49PBP	Right angle pigtail, 2-wire	100

FMVSS	(2) R
MATERIALS	Polycarbonate lens and housing
VOLT/AMP	12.8VDC - .030A
WT/DIMS	.22 lbs. / 4.313" x 4.313" x 2"
WARRANTY	Lifetime LED Warranty

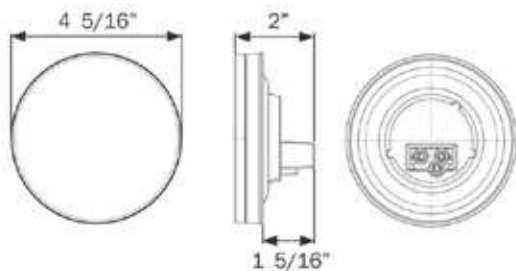

BUL11 SERIES 4" Round Sealed Clear DOT LED Back-Up Lights

- Sonically sealed, waterproof
- Certified for back-up light function when installed as pair in two-lamp system [SAE (2)R]
- Available in grommet and flange mount models
- Grommet mount version available with standard 2-pin, or optional weathertight connection
- Grommet mount version available in 12V and 24V



LED DOT COMPLIANT
BACK-UP LIGHTS



BUL11CB



4 5/16" diameter



HOLE CUT-OUT: 4.5"

BULK P/N	POLYPACK P/N	DESCRIPTION	QTY
CLEAR BACK-UP LIGHTS - 10 DIODES			
BUL11CB	BUL11CBP	12V, two-pin connection	10
BUL11CKB	BUL11CKBP	12V kit: BUL11CB, A45GB & A49PB	10
BUL11CMB	BUL11CMBP	12V, weathertight connection	10
BUL11CM24B	BUL11CM24BP	24V, weathertight connection	10

CLEAR BACK-UP LIGHT WITH REFLEX - 10 DIODES			
BUL11CBX	BUL11CBXP	12V, two-pin connection	10

ACCESSORIES			
A45GB	A45GBP	Grommet	50
A45CB	A45CBP	Pigtail, 2-wire	100
A49PB	A49PBP	Right angle pigtail, 2-wire	100

FMVSS	(2) R		
MATERIALS	Polycarbonate lens and housing		
VOLT/AMP	12.8VDC - 0.26A		
WT/DIMS	BUL11CB/CKB:	.309 lbs. / 4.313" x 4.313" x 1.625"	
	BUL11CMB/CM24B:	.309 lbs. / 4.313" x 4.313" x 1.625"	
	BUL11CBX:	.353 lbs. / 5.75" x 5.75" x 1.625"	
WARRANTY	Lifetime LED Warranty		



BUL11CBX

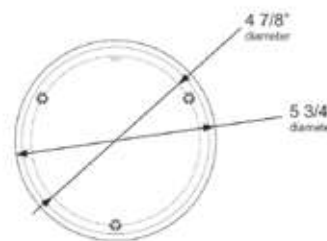

4 7/8" diameter

5 3/4" diameter

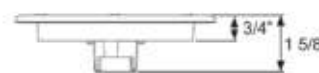

HOLE CUT-OUT: 4.5"



BUL23/53 SERIES 4" Round Sealed Clear DOT LED Back-Up Lights



- Sonically sealed, waterproof
- Certified for back-up light function when installed as pair in two-lamp system [SAE (2)R]
- High diode count; choose from 27- or 36-LED models
- 27-LED version available in 12V and 24V

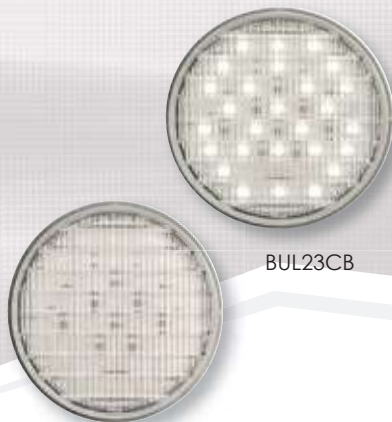

BUL23CB



BUL53CB

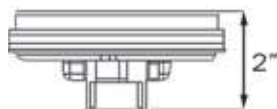
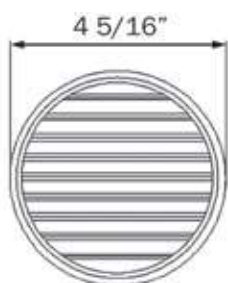

HOLE CUT-OUT: 4.5"

BULK P/N	POLYPACK P/N	DESCRIPTION	QTY
CLEAR BACK-UP LIGHTS - 27 DIODES			
BUL23CB	BUL23CBP	12V, two-pin connection	10
BUL23C24B	BUL23C24BP	24V, two-pin connection	10
CLEAR BACK-UP LIGHT - 36 DIODES			
BUL53CB	BUL53CBP	12V, two-pin connection	10
BUL53CKB	BUL53CKBP	12V Kit: BUL53CB, A45GB & A49PB	10
ACCESSORIES			
A45GB	A45GBP	Grommet	50
A45CB	A45CBP	Pigtail, 2-wire	100
A49PB	A49PBP	Right angle pigtail, 2-wire	100

FMVSS	(2) R
MATERIALS	Polycarbonate lens and housing
VOLT/AMP	BUL23: 12.8VDC - 0.145A BUL53: 12.8VDC - 0.275A
WT/DIMS	.309 lbs. / 4.313" x 4.313" x 2"
WARRANTY	Lifetime LED Warranty

BUL111 SERIES GloLight® 6" Oval Sealed DOT LED Back-Up Lights

GloLight®

PATENTED TECHNOLOGY

- Sonically sealed, waterproof
- Certified for back-up light function when installed as pair in two-lamp system [SAE (2)R]

BULK P/N	POLYPACK P/N	DESCRIPTION	QTY
CLEAR BACK-UP LIGHTS - 22 DIODES			
BUL111CB	BUL111CBP	Standard two-pin connection	10
ACCESSORIES			
A70GB	A70GBP	Grommet	50
A45CB	A45CBP	Pigtail, 2-wire	100
A49PB	A49PBP	Right angle pigtail, 2-wire	100



BUL111CB

LED DOT COMPLIANT
BACK-UP LIGHTS

FMVSS	(2) R
MATERIALS	Polycarbonate lens and housing
VOLT/AMP	12.8VDC - 0.386A
WT/DIMS	.265 lbs. / 6.5" x 2.375" x 1.75"
WARRANTY	Lifetime LED Warranty

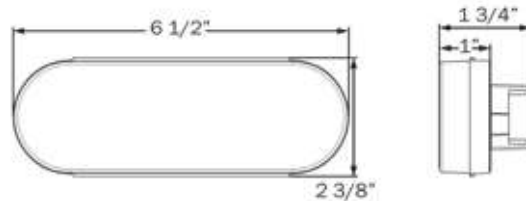

HOLE CUT-OUT: 6.85" x 2.52" (1.26" R)



BUL12 SERIES FLEET Count™ 6" Oval Sealed DOT LED Back-Up Lights



BUL12CB



BUL12CFB

- Sonically sealed, waterproof
- Available with standard or weathertight connection
- Flange mount models available for recess or surface mount installation
- Certified for back-up light function when installed as pair in two-lamp system [SAE (2)R]

BULK P/N	POLYPACK P/N	DESCRIPTION	QTY
CLEAR BACK-UP LIGHTS - 6 DIODES			
BUL12CB	BUL12CBP	Recess mount, 2-pin	10
BUL12CFB	BUL12CFBP	Recess flange mount, 2-pin	10
BUL12CKB	BUL12CKBP	Kit with A70GB and A45CB, 2-pin	10
BUL12CSB	BUL12CSBP	Surface flange mount, hard wired	10
ACCESSORIES			
A70GB	A70GBP	Grommet	50
A45CB	A45CBP	Pigtail, 2-wire	100
A49PB	A49PBP	Right angle pigtail, 2-wire	100
A78CB1	A78CB1P	Chrome trim ring, snap-on	25

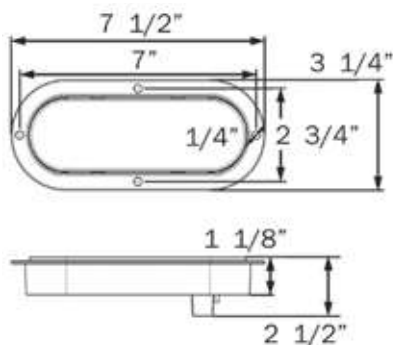

BUL12CFB

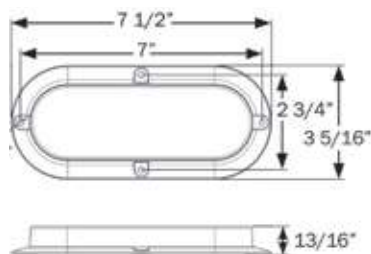

BUL12CSB

FMVSS	(2) R
MATERIALS	Polycarbonate lens and housing
VOLT/AMP	12.8VDC - 0.260A
WT/DIMS	.265 lbs. / 6.5" x 2.25" x 1.75"
WARRANTY	Lifetime LED Warranty

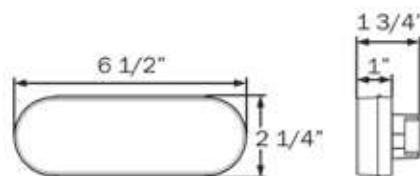

BUL12CB

BUL002 SERIES ONE™ 6" Oval Sealed DOT LED Back-Up Lights

ONE[™]
LED LAMPS

- Sonically sealed, waterproof
- Certified for back-up light function when installed as pair in two-lamp system [SAE (2)R]

BULK P/N	POLYPACK P/N	DESCRIPTION	QTY
CLEAR BACK-UP LIGHTS - 1 DIODE			
BUL002CB	BUL002CBP	Standard two-pin connection	10
BUL002CM3B	BUL002CM3BP	Weathertight connection	10
ACCESSORIES			
A70GB	A70GBP	Grommet	50
A45CB	A45CBP	Pigtail, 2-wire	100
A49PB	A49PBP	Right angle pigtail, 2-wire	100
A45PMB	A45PMBP	Pigtail, weathertight	50



BUL002CB

LED DOT COMPLIANT
BACK-UP LIGHTS

FMVSS	(2) R
MATERIALS	Polycarbonate lens and housing
VOLT/AMP	12.8VDC - 0.30A
WT/DIMS	.265 lbs. / 6.5" x 2.375" x 1.75"
WARRANTY	Lifetime LED Warranty

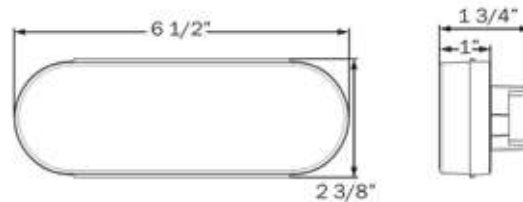

HOLE CUT-OUT: 6.85" x 2.52" (1.26" R)



BUL10/22/52 SERIES 6" Oval Sealed Clear DOT LED Back-Up Lights



BUL10CB

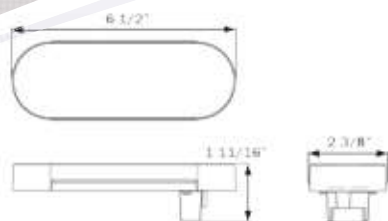

HOLE CUT-OUT: 6.85" x 2.5" (1.25" R)



BUL22CB



BUL52CB

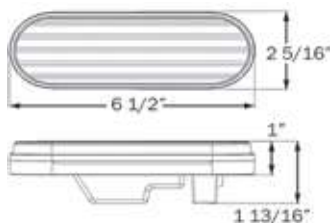

HOLE CUT-OUT: 6.85" x 2.5" (1.25" R)

- Sonically sealed, waterproof
- Certified for back-up light function when installed as pair in two-lamp system [SAE (2)R]
- Low to high diode count; choose from 10-, 27- or 36-LED models
- Accept standard two-pin plugs; BUL10 available with standard or weathertight connection

BULK P/N	POLYPACK P/N	DESCRIPTION	QTY
CLEAR BACK-UP LIGHTS - 10 DIODES			
BUL10CB	BUL10CBP	Standard two-pin connection	10
BUL10CMB	BUL10CMBP	Weathertight connection	10
CLEAR BACK-UP LIGHT - 27 DIODES			
BUL22CB	BUL22CBP	Standard two-pin connection	10
CLEAR BACK-UP LIGHT - 36 DIODES			
BUL52CB	BUL52CBP	Standard two-pin connection	10
ACCESSORIES			
A70GB	A70GBP	Grommet	50
A45CB	A45CBP	Pigtail, 2-wire	100
A49PB	A49PBP	Right angle pigtail, 2-wire	100
A45PMB	A45PMBP	Pigtail, weathertight	50
FMVSS	(2) R		
MATERIALS	Polycarbonate lens and housing		
VOLT/AMP	BUL10:	12.8VDC - 0.260A	
	BUL22:	12.8VDC - 0.125A	
	BUL52:	12.8VDC - 0.275A	
WT/DIMS	BUL10:	.265 lbs. / 6.438" x 2.25" x 1.75"	
	BUL22/52:	.397 lbs. / 6.5" x 2.313" x 1.813"	
WARRANTY	Lifetime LED Warranty		

BUL35/90 SERIES Sealed Clear DOT LED Back-Up Lights

- Sonically sealed, waterproof
- Certified for back-up light function when installed as pair in two-lamp system [SAE (2)R]
- BUL35 is 5.5" x 3.5" recess mount model that accepts standard two-pin plugs
- BUL90 is 7" surface mount model, hard wired, with separate ground wire; designed for transit vehicles



LED DOT COMPLIANT
BACK-UP LIGHTS



BUL35CB



BULK P/N	POLYPACK P/N	DESCRIPTION	QTY
CLEAR 5.5" x 3.5" BACK-UP LIGHT - 16 DIODES			
BUL35CB	BUL35CBP	Standard two-pin connection, 12V	10
CLEAR 7" BACK-UP LIGHT - 42 DIODES			
BUL90CB	BUL90CBP	12V, hard wired	5
BUL90C24B	BUL90C24BP	24V, hard wired	5
ACCESSORIES			
A33GB	A33GBP	Grommet for BUL35CB	50
A45CB	A45CBP	Pigtail, 2-wire	100
A49PB	A49BPB	Right angle pigtail, 2-wire	100

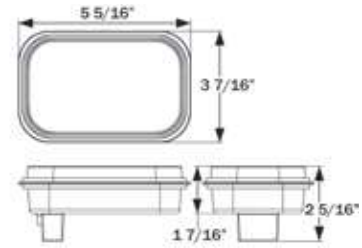

HOLE CUT-OUT: 5.462" x 3.562" (1" R)

FMVSS	(2) R
MATERIALS	Polycarbonate lens and housing
VOLT/AMP	BUL35: 12.8VDC - 0.295A BUL90: 12.8VDC - 0.301A BUL90: 24.0VDC - 0.089A
WT/DIMS	BUL35: .397 lbs. / 5.313" x 3.438" x 2.313" BUL90: .970 lbs. / 7" x 7" x 1.438"
WARRANTY	Lifetime LED Warranty



BUL90CB

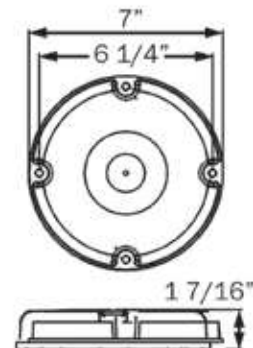



SLL43 SERIES 4" Round Sealed LED Warning Lamps



SLL43AB1
SLL43AB2

- Sonically sealed, waterproof
- Flashing lights with triple-flash function, meeting SAE J595 and J845 standards for Class 2 and Class 3 directional warning lamps
- Use two Function 1 or Function 2 lights for synchronous flashing or pair a Function 1 with a Function 2 light for alternating flash pattern
- Accepts standard PL-3 plugs
- Operating voltage 9-30VDC, suitable for 12V or 24V systems

BULK P/N	POLYPACK P/N	DESCRIPTION	QTY
4" ROUND WARNING LAMPS - 22 DIODES			
SLL43AB1	SLL43AB1P	12V-24V Function 1	10
SLL43AB2	SLL43AB2P	12V-24V Function 2	10
SLL43AKB1	SLL43AKB1P	12V-24V Function 1, kit with A45GB & A45PB	10
SLL43AKB2	SLL43AKB2P	12V-24V Function 2, kit with A45GB & A45PB	10
ACCESSORIES			
A45GB	A45GBP	Grommet, 4" round	50
A45PB	A45PBP	Pigtail, 3-wire	100
A47PB	A47PBP	Right angle pigtail, 3-wire	100

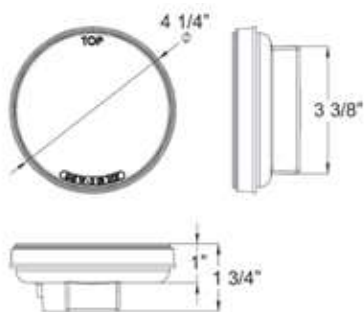

HOLE CUT-OUT: 4.5"

FMVSS	W-2
MATERIALS	Polycarbonate lens and housing
VOLT/AMP	12.8VDC - 0.56A
WT/DIMS	.60 lbs. / 4.25" x 4.25" x 1.75"
WARRANTY	Lifetime LED Warranty

SLL72 SERIES 6" Oval Sealed LED Warning Lamps



- Sonically sealed, waterproof
- Flashing lights with triple-flash function, meeting SAE J595 and J845 standards for Class 2 and Class 3 directional warning lamps
- Use two Function 1 or Function 2 lights for synchronous flashing or pair a Function 1 with a Function 2 light for alternating flash pattern
- Accepts standard PL-3 plugs
- Operating voltage 9-30VDC, suitable for 12V or 24V systems



SLL72AB1
SLL72AB2

BULK P/N	POLYPACK P/N	DESCRIPTION	QTY
6" OVAL WARNING LAMPS - 22 DIODES			
SLL72AB1	SLL72AB1P	12V-24V Function 1	10
SLL72AB2	SLL72AB2P	12V-24V Function 2	10
SLL72AKB1	SLL72AKB1P	12V-24V Function 1, kit with A70GB & A45PB	10
SLL72AKB2	SLL72AKB2P	12V-24V Function 2, kit with A70GB & A45PB	10
ACCESSORIES			
A70GB	A70GBP	Grommet, 6" oval	50
A45PB	A45PBP	Pigtail, 3-wire	100
A47PB	A47PBP	Right angle pigtail, 3-wire	100

FMVSS	W-2
MATERIALS	Polycarbonate lens and housing
VOLT/AMP	12.8VDC - 0.54A
WT/DIMS	.62 lbs. / 6.5" x 2.375" x 1.75"
WARRANTY	Lifetime LED Warranty

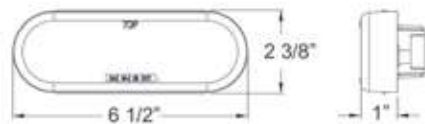

HOLE CUT-OUT: 6.85" x 2.5" (1.25" R)

LED WARNING LIGHTS



SLL93 SERIES 7" Round LED Warning Lights for Surface Mount

- 8-LED school bus warning lights
- Acrylic lens, die cast aluminum base plate
- Sealed, waterproof design



SLL93RB



SLL93AB



SLL93AB with A94VB

BULK P/N	POLYPACK P/N	DESCRIPTION	QTY
RED WARNING LIGHTS - 8 DIODES			
SLL93RB	SLL93RBP	Warning light, 12V	5
YELLOW WARNING LIGHTS - 8 DIODES			
SLL93AB	SLL93ABP	Warning light, 12V	5
ACCESSORIES			
A94VB	A94VBP	Black Steel Visor	25

FMVSS	W2 SAE J887
MATERIALS	Acrylic len, die cast aluminum base
VOLT/AMP	12.8VDC - 2.0A
WT/DIMS	1.3875lb. / 7.25" x 7.25" x 1.9"
WARRANTY	Lifetime LED Warranty

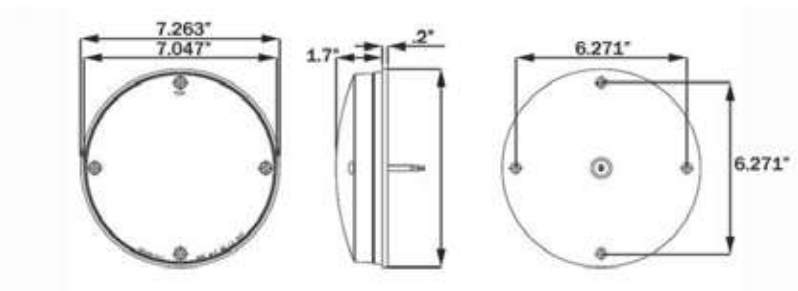

GloLight® M1 SERIES 6.5" LED Marker/Clearance Lights

PATENTED TECHNOLOGY

- Sealed, waterproof design
- Hard wired, includes separate ground wire

BULK P/N	POLYPACK P/N	DESCRIPTION	QTY
YELLOW - 13 DIODES			
11212307B	11212355P	.180 male bullets	50
11212376B	11212356P	Clear lens, .180 male bullets	50
-	11212335P	Kit: .180 male bullets, chrome bezel	10
-	11212336P	Clear lens kit: .180 male bullets, chrome bezel	10
RED - 13 DIODES			
11212309B	11212357P	.180 male bullets	50
11212378B	11212358P	Clear lens, .180 male bullets	50
-	11212337P	Kit: .180 male bullets, chrome bezel	10
-	11212338P	Clear lens kit: .180 male bullets, chrome bezel	10
ACCESSORIES			
00212317B	00212327P	Bezel	200/20

FMVSS	P2
MATERIALS	Polycarbonate lens, housing and bezel
VOLT/AMP	12.8VDC - 0.12A
WT/DIMS	.132 lbs. / 6.625" x 2.188" x 1"
WARRANTY	Three Year Warranty

GloLight®

Panelite
MILLENNIUM SERIES™



M1 LED WITH BEZEL



M1 CLEAR LENS LED WITH BEZEL

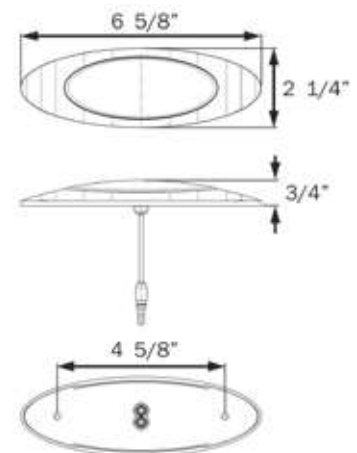

HOLE CUT-OUT: 1.5"

GloLight®

Panelite
MILLENNIUM SERIES™

GloLight® M3 SERIES 3" LED Marker/Clearance Lights

PATENTED TECHNOLOGY

- Sealed, waterproof design
- Hard wired, includes separate ground wire



M3 LED WITH BEZEL



M3 CLEAR LENS LED WITH BEZEL

BULK P/N	POLYPACK P/N	DESCRIPTION	QTY
YELLOW - 5 DIODES			
11212207B	11212255P	.180 male bullets	50
11212276B	11212256P	Clear lens, .180 male bullets	50
-	11212235P	Kit: .180 male bullets with chrome bezel	10
-	11212236P	Clear lens kit: .180 male bullets with chrome bezel	10
RED - 5 DIODES			
11212209B	11212257P	.180 male bullets	50
11212278B	11212258P	Clear lens, .180 male bullets	50
-	11212237P	Kit: .180 male bullets with chrome bezel	10
-	11212238P	Clear lens kit: .180 male bullets with chrome bezel	10
ACCESSORIES			
00212217B	00212227P	Bezel	500/20

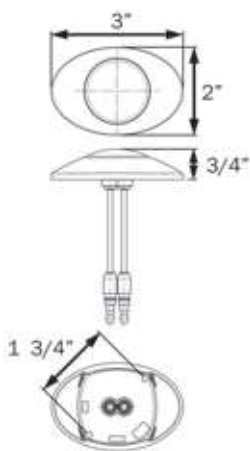

HOLE CUT-OUT:
1.375"

FMVSS	P2
MATERIALS	Polycarbonate lens, housing and bezel
VOLT/AMP	12.8VDC - 0.12A
WT/DIMS	.132 lbs. / 3" x 2" x 1"
WARRANTY	Three Year Warranty

GloLight® M5 SERIES 4" LED Marker/Clearance Lights

PATENTED TECHNOLOGY

- Sealed, waterproof design
- Hard wired, includes separate ground wire

BULK P/N	POLYPACK P/N	DESCRIPTION	QTY
YELLOW - 6 DIODES			
11212700B	11212708P	.180 male bullets	10
11212702B	11212710P	Clear lens, .180 male bullets	10
-	11212704P	Kit: .180 male bullets with chrome bezel	10
-	11212706P	Clear lens kit: .180 male bullets with chrome bezel	10
RED - 6 DIODES			
11212701B	11212709P	.180 male bullets	10
11212703B	11212711P	Clear lens, .180 male bullets	10
-	11212705P	Kit: .180 male bullets with chrome bezel	10
-	11212707P	Clear lens kit: .180 male bullets with chrome bezel	10
ACCESSORIES			
00212717B	00212727P	Bezel	500/20

FMVSS	P2
MATERIALS	Polycarbonate lens, housing and bezel
VOLT/AMP	12.8VDC - 0.033A
WT/DIMS	.066 lb. / 4.156" x 1.5" x .75"
WARRANTY	Three Year Warranty

GloLight®

Panelite
MILLENNIUM SERIES™



M5 LED WITH BEZEL



M5 CLEAR LENS LED WITH BEZEL



HOLE CUT-OUT: 1"



M1 SERIES Millennium Series® 6.5" Sealed LED Marker/Clearance Lights

- Sealed, waterproof design
- Hard wired, includes separate ground wire
- Available with .180 male bullets or metripack connector
- Choose from light only or kit with chrome bezel



M1 LED WITH BEZEL



M1 CLEAR LENS LED WITH BEZEL



M1 LED WITH BEZEL



M1 CLEAR LENS LED WITH BEZEL

BULK P/N	POLYPACK P/N	DESCRIPTION	QTY
YELLOW - 4 DIODES			
00212307B	00212355P	.180 male bullets	50/10
00212376B	00212356P	Clear lens, .180 male bullets	50/10
-	00212335P	Kit: .180 male bullets, bezel	10
-	00212336P	Kit: Clear lens, .180 male bullets, bezel	10
-	00212365P	Metripack connector	10
-	00212345P	Kit: Metripack connector, bezel	10
-	00212346P	Kit: Clear lens, metripack connector, bezel	10
RED - 4 DIODES			
00212309B	00212357P	.180 male bullets	50/10
00212378B	00212358P	Clear lens, .180 male bullets	50/10
-	00212337P	Kit: .180 male bullets, bezel	10
-	00212338P	Kit: Clear lens, .180 male bullets, bezel	10
00212316B	00212367P	Metripack connector	100/10
00212386B	00212368P	Clear lens, metripack connector	100/10
-	00212347P	Kit: Metripack connector, bezel	10
ACCESSORIES			
00212317B	00212327P	Bezel	200/20



FMVSS	P2
MATERIALS	Polycarbonate lens, housing and bezel
VOLT/AMP	12.8VDC - 0.12A
WT/DIMS	.132 lbs. / 6.625" x 2.188" x 1"
WARRANTY	Three Year Warranty

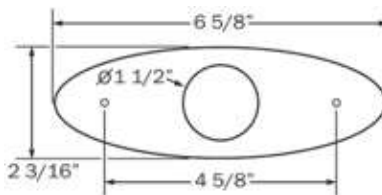

HOLE CUT-OUT: 1.5"

M3 SERIES Millennium Series® 3" Sealed LED Marker/Clearance Lights

- Sealed, waterproof design
- Hard wired, includes separate ground wire
- Available with .180 male bullets or metripack connector
- Choose from light only or kit with chrome bezel



LED MILLENNIUM SERIES

BULK P/N	POLYPACK P/N	DESCRIPTION	QTY
YELLOW - 2 DIODES			
00212207B	00212255P	.180 male bullets	50/10
00212276B	00212256P	Clear lens, .180 male bullets	50/10
-	00212235P	Kit: .180 male bullets, bezel	10
-	00212236P	Kit: Clear lens, .180 male bullets, bezel	10
00212213B	00212263P	Clear lens, metripack connector	50/10
RED - 2 DIODES			
00212209B	00212257P	.180 male bullets	50/10
00212278B	00212258P	Clear lens, .180 male bullets	50/10
-	00212237P	Kit: .180 male bullets, bezel	10
-	00212238P	Kit: Clear lens, .180 male bullets, bezel	10
-	00212254P	Clear lens, metripack connector	100
ACCESSORIES			
00212217B	00212227P	Bezel	500/20

FMVSS	P2
MATERIALS	Polycarbonate lens, housing and bezel
VOLT/AMP	12.8VDC - 0.36A
WT/DIMS	.132 lbs. / 3" x 2" x 1"
WARRANTY	Three Year Warranty

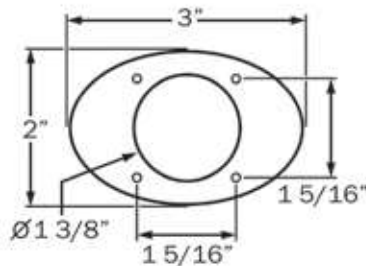

HOLE CUT-OUT: 1.375"



M3 LED WITH BEZEL



M3 CLEAR LENS LED WITH BEZEL



M3 LED WITH BEZEL



M3 CLEAR LENS LED WITH BEZEL





M4 SERIES Millennium Series® 9" Sealed LED Lights

- Sealed, waterproof design
- Hard wired, includes separate ground wire
- Chrome trim ring included in kits or available separately

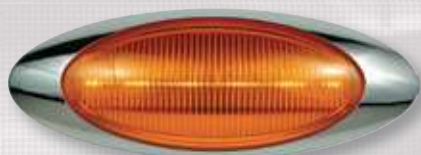

M4 LED MARKER/CLEARANCE LIGHTS WITH BEZEL

BULK P/N	POLYPACK P/N	DESCRIPTION	QTY
YELLOW MARKER/CLEARANCE - 6 DIODES			
00212104B	00212155P	.180 male bullets	10
-	00212135P	Kit: .180 male bullets, bezel	10
RED MARKER/CLEARANCE - 6 DIODES			
-	00212157P	.180 male bullets	10
-	00212137P	Kit: .180 male bullets, bezel	10
ACCESSORIES			
00212117B	00212127P	Bezel	70/20

FMVSS	P2
MATERIALS	Polycarbonate lens, housing and bezel
VOLT/AMP	12.8VDC - 0.090A
WT/DIMS	.132 lbs. / 9" x 3.25" x 1"
WARRANTY	Three Year Warranty

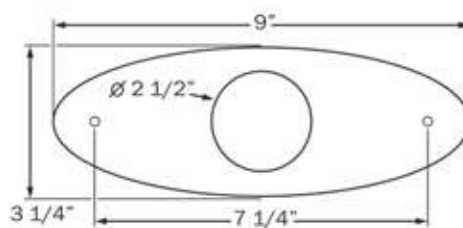

HOLE CUT-OUT: 2.5"

M5 SERIES Millennium Series® 4" Sealed LED Marker/Clearance Lights

- Sealed, waterproof design
- Hard wired, includes separate ground wire
- Available with .180 male bullets or metripack connector
- Choose from light only or kit with chrome bezel

BULK P/N	POLYPACK P/N	DESCRIPTION	QTY
YELLOW - 3 DIODES			
00212700B	00212708P	.180 male bullets	10
00212702B	00212710P	Clear lens, .180 male bullets	10
-	00212704P	Kit: .180 male bullets, bezel	10
-	00212706P	Kit: Clear lens, .180 male bullets, bezel	10
-	00212712P	Clear lens, metripack connector	10
RED - 3 DIODES			
00212701B	00212709P	.180 male bullets	10
00212703B	00212711P	Clear lens, .180 male bullets	10
-	00212705P	Kit: .180 male bullets, bezel	10
-	00212707P	Kit: Clear lens, .180 male bullets, bezel	10
ACCESSORIES			
00212717B	00212727P	Bezel	500/20

FMVSS	P2
MATERIALS	Polycarbonate lens, housing and bezel
VOLT/AMP	12.8VDC - 0.033A
WT/DIMS	.066 lb. / 4.156" x 1.5" x .75"
WARRANTY	Three Year Warranty

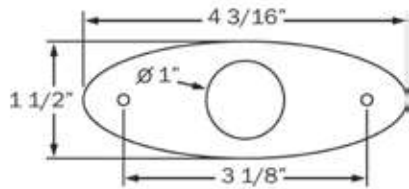

HOLE CUT-OUT: 1"

Panelite
MILLENNIUM SERIES™



M5 LED WITH BEZEL



M5 CLEAR LENS LED WITH BEZEL



M5 LED WITH BEZEL

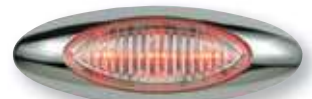

M5 CLEAR LENS LED WITH BEZEL





MCL11S SERIES 3/4" Sealed LED Marker/Clearance Lights with Theft-Deterrent Design



PATENTED TECHNOLOGY

- Sealed, waterproof design
- Recess mount lights with theft-deterrent mounting design
- Easy to install: insert light into mounting hole and secure with locking ring
- PC rated: fulfills requirement for marker and clearance light when properly mounted

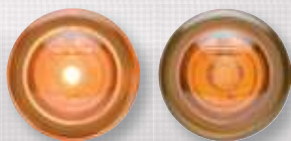

MCL11SAKB



MCL11SRKB



A11SRB

BULK P/N	POLYPACK P/N	DESCRIPTION	QTY
YELLOW - 1 DIODE			
MCL11SAB	MCL11SABP	Light with gasket, .180 bullets	50
MCL11SAKB	MCL11SAKBP	Light with gasket and locking ring .180 bullets	50
MCL11SAK1B	MCL11AK1BP	Light with gasket and locking ring	50
RED - 1 DIODE			
MCL11SRB	MCL11SRBP	Light with gasket, .180 bullets	50
MCL11SRKB	MCL11SRKBP	Light with gasket and locking ring .180 bullets	50
MCL11SRK1B	MCL11SRKBP	Light with gasket and locking ring	50
ACCESSORIES			
A11SRB	A11SRBP	Stainless steel locking ring	100

FMVSS	PC
MATERIALS	Polycarbonate lens and housing, stainless steel locking ring, EPDM rubber gasket
VOLT/AMP	12.8VDC - .06A
WT/DIMS	.10 lbs. / 1" x 1" x .875"
WARRANTY	Lifetime LED Warranty

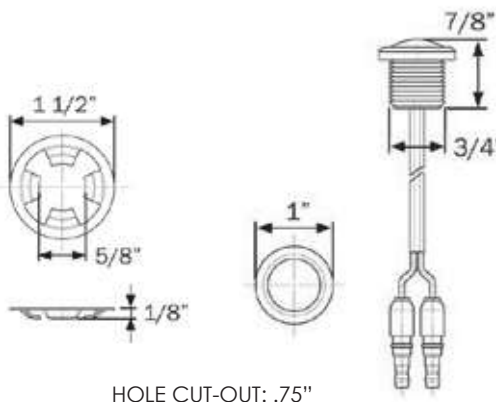

MCL110 SERIES GloLight® Uni-Lite™ 3/4" LED Non-Directional Marker/Clearance Lights



SEALED LED MARKER/
CLEARANCE LIGHTS

PATENTED TECHNOLOGY

- Sealed, waterproof design
- PC rated when mounted in any direction - 360 degrees!
- Hard wired, includes separate ground wire
- Choose from light only or kit with A11GB grommet



MCL110AB



MCL110RB



MCL110AKB



MCL110RKB

BULK P/N	POLYPACK P/N	DESCRIPTION	QTY
YELLOW - PC RATED - 2 DIODES			
MCL110AB	MCL110ABP	Light only	50
MCL110AKB	MCL110AKBP	Light with A11GB grommet	50
MCL110AKBF	MCL110AKBFP	Light kit with grommet, .156 female barrels on 8" leads	50
MCL110AKPG	MCL110AKPGP	Light with grommet, .180 bullets	50
RED - PC RATED - 2 DIODES			
MCL110RB	MCL110RBP	Light only	50
MCL110RKB	MCL110RKBP	Light with A11GB grommet	50
MCL110RKBF	MCL110AKBFP	Light kit with grommet, .156 female barrels on 8" leads	50
MCL110RKPG	MCL110RKPGP	Light with grommet, .180 bullets	50
ACCESSORIES			
A11GB	A11GBP	Grommet	100
A12GB	A12GBP	Sealing grommet, .070-.125"	100
A14GB	A14GBP	Sealing grommet, .125-.250"	100
A11PB	A11PBP	Black plastic snap-in flange	100
A11SSB	A11SSBP	Stainless steel grommet cover	100
A11AXB	A11AXBP	Yellow reflector	100
A11RXB	A11RXBP	Red reflector	100

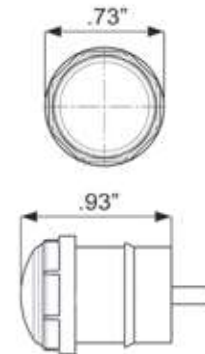

FMVSS	PC
MATERIALS	Polycarbonate lens and housing
VOLT/AMP	12.8VDC - 0.08A
WT/DIMS	.022 lbs. / .073" x .073" x 0.938"
WARRANTY	Lifetime LED Warranty



A11RXB

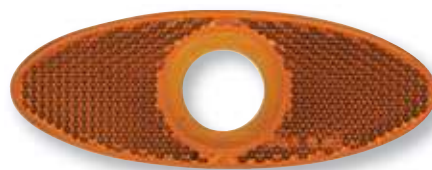

A11AXB

GloLight

MCL111 SERIES GloLight® Uni-Lite™ 3/4" Sealed LED Marker/Clearance Lights



PATENTED TECHNOLOGY

- Sealed, waterproof design
- PC rated two diode models
- Hard wired, includes separate ground wire
- Available with optional plugs
- Choose from light only or kit with A11GB grommet
- Dual function models MCL121AK9PVG/RK9PVG provide a supplemental stop/turn function



MCL111AKB



MCL111RKB

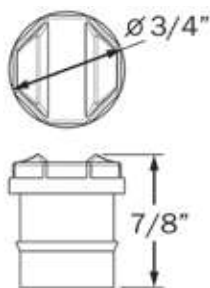

A11PB

BULK P/N	POLYPACK P/N	DESCRIPTION	QTY
YELLOW - PC RATED - 2 DIODES			
MCL111AB	MCL111ABP	Light only	50
MCL111AKB	MCL111AKBP	Light with A11GB grommet	50
MCL111AKPG	MCL111AKPGP	Kit with .180 male bullets, A11GB	50
MCL121AK9PVG	MCL121AK9PVG P	Supplemental turn - kit with closed grommet, .180 male bullets	20
RED - PC RATED - 2 DIODES			
MCL111RB	MCL111RBP	Light only	50
MCL111RKB	MCL111RKB P	Light with A11GB grommet	50
MCL111RKFP G	MCL111RKFP GP	Kit with .156 female bullets, A11GB	50
MCL111RKPG	MCL111RKPG P	Kit with .180 male bullets, A11GB	50
MCL121RK9PVG	MCL121RK9PVG P	Supplemental turn - kit with closed grommet, .180 male bullets	20
ACCESSORIES			
A11GB	A11GBP	Grommet	100
A12GB	A12GBP	Sealing grommet, .070-.125"	100
A14GB	A14GBP	Sealing grommet, .125-.250"	100
A11PB	A11PBP	Black plastic snap-in flange	100
A11SSB	A11SSBP	Stainless steel grommet cover	100
A11AXB	A11AXBP	Yellow reflector	100
A11RXB	A11RXBP	Red reflector	100

FMVSS	PC
MATERIALS	Polycarbonate lens and housing
VOLT/AMP	12.8VDC - 0.04A
WT/DIMS	.022 lbs. / .75" x .75" x 0.875"
WARRANTY	Lifetime LED Warranty

MCL112 SERIES GloLight® Uni-Lite™ 3/4" Sealed LED Marker/Clearance Lights

GloLight®

SEALED LED MARKER/
CLEARANCE LIGHTS

PATENTED TECHNOLOGY

- Sealed, waterproof design
- P2 rated single diode models
- Hard wired, includes separate ground wire
- Choose from light only or kit with A11GB grommet



MCL112AKB



MCL112RKB

BULK P/N	POLYPACK P/N	DESCRIPTION	QTY
YELLOW - P2 RATED - 1 DIODE			
MCL112AB	MCL112ABP	Light only	50
MCL112AKB	MCL112AKBP	Light with A11GB grommet	50
RED - P2 RATED - 1 DIODE			
MCL112RB	MCL112RBP	Light only	50
MCL112RKB	MCL112RKBP	Light with A11GB grommet	50
ACCESSORIES			
A11GB	A11GBP	Grommet	100
A12GB	A12GBP	Sealing grommet, .070-.125"	100
A14GB	A14GBP	Sealing grommet, .125-.250"	100
A11PB	A11PBP	Black plastic snap-in flange	100
A11SSB	A11SSBP	Stainless steel grommet cover	100
A11AXB	A11AXBP	Yellow reflector	100
A11RXB	A11RXBP	Red reflector	100

FMVSS	P2
MATERIALS	Polycarbonate lens and housing
VOLT/AMP	12.8VDC - .047A
WT/DIMS	.022 lbs. / .75" x .75" x 0.875"
WARRANTY	Lifetime LED Warranty

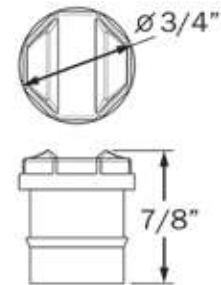



MCL10 SERIES Uni-Lite™ 3/4" LED Non-Directional Marker/Clearance Lights



MCL10AB



MCL10RB



MCL10AKB



MCL10RKB

- Sonically sealed, waterproof
- PC rated when mounted in any direction - 360 degrees!
- Hard wired, includes separate ground wire
- Choose from light only or kit with A11GB grommet

BULK P/N	POLYPACK P/N	DESCRIPTION	QTY
YELLOW - 1 DIODE			
MCL10AB	MCL10ABP	Light only	50
MCL10AKB	MCL10AKBP	Light with A11GB grommet	50
MCL10CAK14B	MCL10CAK14BP	Clear lens light with A11GB grommet	50
RED - 1 DIODE			
MCL10RB	MCL10RBP	Light only	50
MCL10RKB	MCL10RKBP	Light with A11GB grommet	50
MCL10CRK14B	MCL10CRK14BP	Clear lens light with A11GB grommet	50
ACCESSORIES			
A11GB	A11GBP	Grommet	100
A12GB	A12GBP	Sealing grommet for material thickness .070 - .125"	100
A14GB	A14GBP	Sealing grommet for material thickness .125 - .250"	100
A11PB	A11PBP	Snap-in mounting flange	100
A11SSB	A11SSBP	Stainless steel trim ring	100
A11AXB	A11AXBP	Yellow oval reflector, self adhesive	100
A11RXB	A11RXBP	Red oval reflector, self adhesive	100

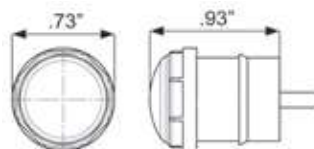

HOLE CUT-OUT: .75"

FMVSS	PC
MATERIALS	Polycarbonate lens and housing
VOLT/AMP	12.8VDC - .041A
WT/DIMS	.022 lbs. / .073" x .073" x .938"
WARRANTY	Lifetime LED Warranty

MCL11 SERIES

Uni-Lite™ 3/4" Sealed LED Marker/Clearance Lights



- Sealed, waterproof design
- Hard wired, includes separate ground wire

BULK P/N	POLYPACK P/N	DESCRIPTION	QTY
YELLOW - PC RATED - 2 DIODES			
MCL11AB	MCL11ABP	Light only	50
MCL11APG	MCL11APGP	Light with .180 male bullets	50
MCL11CAB	MCL11CABP	Light only, clear lens	50
MCL11AKB	MCL11AKBP	Kit with A11GB grommet	50
MCL11CAKB	MCL11CAKBP	Kit with A11GB, clear lens	50
MCL11CAKPG	-	Kit with A11GB, clear lens, .180 male bullets	50
MCL11CAKBF	-	Kit with A11GB, clear lens, .156 female barrels	50
MCL11AHPG	-	Kit with .180 male bullets, A11GB	50
MCL11AKAB	MCL11AKABP	Kit with .156 female barrels, A11GB	50
MCL11AKBF	MCL11AKBFP	Kit with .156 female barrels, A11GB	50
MCL11AK12B	-	Kit with 12" leads, A11GB	50
MCL11AK12PG	-	Kit with 12" leads, A11GB, .156 male bullets	50
MCL11AKPVG	-	Kit with sealed grommet, .180 male bullets	50
-	MCL11AKBSSP	Kit with 12" leads, A11GB, A11SSB	50
MCL11A24KB	-	Kit with A11GB grommet, 24V	50
MCL11AKPV4G	-	Kit with sealed grommet, .180 male bullets, 24V	50
RED - PC RATED - 2 DIODES			
MCL11RB	MCL11RBP	Light only	50
MCL11RPG	MCL11RPGP	Light with .180 male bullets	50
MCL11CRB	MCL11CRBP	Light only, clear lens	50
MCL11RKB	MCL11RKBP	Kit with A11GB grommet	50
MCL11CRKB	MCL11CRKBP	Kit with A11GB, clear lens	50
MCL11CRKPG	-	Kit with A11GB, clear lens, .180 male bullets	50
MCL11CRKBF	-	Kit with A11GB, clear lens, .156 female barrels	50
MCL11RHPG	-	Kit with .180 male bullets, A11GB	50
MCL11RKAB	-	Kit with .156 female connectors, A11GB	50
MCL11RKBF	MCL11RKBFP	Kit with .156 female barrels, A11GB	50
MCL11RK12B	-	Kit with 12" leads, A11GB	50
MCL11RK12PG	-	Kit with 12" leads, A11GB, .156 male bullets	50
MCL11RKPVG	-	Kit with sealed grommet, .180 male bullets	50
-	MCL11RKBSSP	Kit with 12" leads, A11GB, A11SSB	50
MCL11R24KB	-	Kit with A11GB grommet, 24V	50
MCL11RKPV4G	-	Kit with sealed grommet, .180 male bullets, 24V	50
MCL21RKPV4G	-	Kit with sealed grommet, male amp plug, supplemental turn function	10

See Accessories section at back of catalog or listing on previous pages for additional mounting options



MCL11AB



MCL11RB



MCL11AKB



MCL11RKB

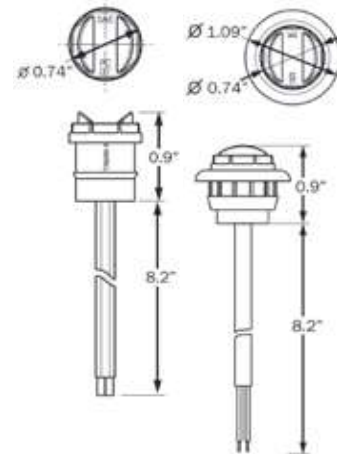

HOLE CUT-OUT: 0.75"

FMVSS PC

MATERIALS

Polycarbonate lens and housing

VOLT/AMP

12.8VDC - 0.03A

WT/DIMS

.022 lbs. / .074" x .074" x 0.90"

WARRANTY

Lifetime LED Warranty

SEALED LED MARKER/
CLEARANCE LIGHTS



MCL12AKB



MCL12RKB



MCL12RK3B



MCL922RB

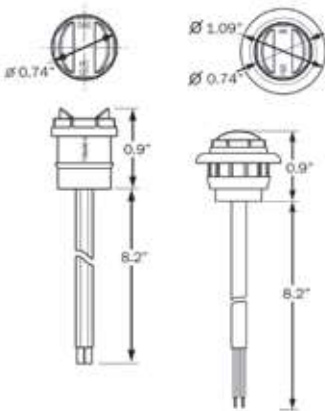

HOLE CUT-OUT: 0.75"

FMVSS P2

MATERIALS

Polycarbonate lens and housing

VOLT/AMP

12.8VDC - 0.47A

WT/DIMS

.022 lbs. / .074" x .074" x 0.90"

WARRANTY

Lifetime LED Warranty

MCL12 SERIES

Uni-Lite™ 3/4" Sealed LED Marker/Clearance Lights - P2

- Sealed, waterproof, P2 rated single diode models
- Hard wired, includes separate ground wire
- Three-piece identification light harnesses available; optional supplemental turn function
- MCL922RB is three-piece identification light bar

BULK P/N	POLYPACK P/N	DESCRIPTION	QTY
YELLOW - P2 RATED - 1 DIODE			
MCL12AB	MCL12ABP	Light only	50
MCL12AKB	MCL12AKBP	Light kit with A11GB	50
MCL12AKPG	-	Light kit with .180 male bullets, A11GB	50
MCL12AK156PG	-	Light kit with .156 male bullets, A11GB	50
RED - P2 RATED - 1 DIODE			
MCL12RB	MCL12RBP	Light only	50
MCL12RKB	MCL12RKBP	Light kit with A11GB	50
MCL12RKPG	-	Light kit with .180 male bullets, A11GB	50
MCL12RK156PG	-	Light kit with .156 male bullets, A11GB	50
RED IDENTIFICATION LIGHT KIT WITH MOLDED HARNESS			
MCL12RK3B	MCL12RK3BP	(3) red MCL12 lights	20
MCL12RK3RMB	-	(3) red MCL12 lights, weathertight plug	20
MCL22RK3B	-	(3) red MCL12 lights, supplemental turn function	20
MCL22RK4B	-	(3) red MCL12 lights, supplemental turn function, amp connector	20
RED IDENTIFICATION LIGHT BAR			
MCL922RB	MCL922RBP	(3) red MCL12 lights, molded bar, black	10
ACCESSORIES			
A11GB	A11GBP	Grommet	100
A12GB	A12GBP	Sealing grommet, .070-.125"	100
A14GB	A14GBP	Sealing grommet, .125-.250"	100
A11PB	A11PBP	Black plastic snap-in flange	100
A11SSB	A11SSBP	Stainless steel grommet cover	100
A11AXB	A11AXBP	Yellow reflector	100
A11RXB	A11RXBP	Red reflector	100
RETAIL			
MCL12AK		Yellow light kit, card/slipover blister	12
MCL12RK		Red light kit, card/slipover blister	12

MCL12AR SERIES Uni-Lite™ 3/4" Sealed LED Fender Lights



- Sealed, waterproof, P2 rated single diode lights pre-installed in durable ABS, surface mount bracket
- Hard wired, includes separate ground wire
- Available with clear or tinted lenses



MCL12ARRB
MCL12ARLB

SEALED LED MARKER/
CLEARANCE LIGHTS

BULK P/N	POLYPACK P/N	DESCRIPTION	QTY
YELLOW / RED FENDER LIGHTS			
MCL12ARLB	MCL12ARLBP	Driver side assembly, 2-wire	50/20
MCL12ARRB	MCL12ARRBP	Passenger side assembly, 2-wire	50/20
MCL12CA2RLB	-	Driver side assembly, clear lens, self grounding	50
MCL12CA2RRB	-	Passenger side assembly, clear lens, self grounding	50
ACCESSORIES			
A11GB	A11GBP	Grommet	100

FMVSS	P2
MATERIALS	Polycarbonate lens and housing
VOLT/AMP	12.8VDC - 0.047A
WT/DIMS	.20 lbs. / 4.75" x 1.625" x 1.25"
WARRANTY	Lifetime LED Warranty

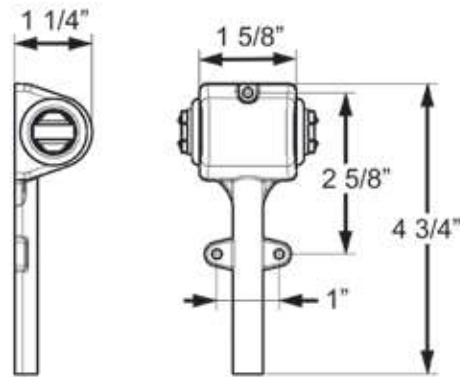

MCL12CA2RLB
MCL12CA2RRB



MCL21/23 SERIES 2" & 2.5" Sealed LED Beehive Style Marker/Clearance Lights

- Sonically sealed, waterproof
- Clearance, side marker, or rear tracking light applications
- Accepts standard two-pin PL-10 plug



MCL21AB



MCL21RB



MCL23AB



MCL23RB

BULK P/N	POLYPACK P/N	DESCRIPTION	QTY
YELLOW - 8 DIODES			
MCL21AB	MCL21ABP	2" light	20
MCL23AB	MCL23ABP	2.5" light	20
RED - 8 DIODES			
MCL21RB	MCL21RBP	2" light	20
MCL23RB	MCL23RBP	2.5" light	20
ACCESSORIES			
A46PB	A46PBP	Straight PL-10 plug, 6" lead	100
A86PB	A86PBP	Straight PL-10 plug, 18" lead	100
A54GB	A54GBP	2" Flush mount grommet	100
A54GK	A54GKP	2" Kit: A54GB and A46PB	100
A55CB	A55CBP	2" Chrome trim ring	20
A55GB	A55GBP	2.5" Flush mount grommet (open back)	50
A56GB	A56GBP	2.5" Recess mount grommet (closed back)	100
A57GB	A57GBP	2.5" Recess mount grommet (open back)	50
A55GK	A55GKP	2.5" Kit: A55GB and A46PB	100
A57GK	A57GKP	2.5" Kit: A57GB and A46PB	100
A57CB	A57CBP	2.5" Chrome trim ring	20
BK5557GB	BK5557GBP	2"/2.5" Cam-on mounting bracket	50

FMVSS	P2
MATERIALS	Polycarbonate lens and housing
VOLT/AMP	MCL21: 12.8VDC - 0.061A MCL23: 12.8VDC - 0.051A
WT/DIMS	MCL21: .110 lbs. / 2" x 2" x 1.75" MCL23: .176 lbs. / 2.5" x 2.5" x 2.313"
WARRANTY	Lifetime LED Warranty

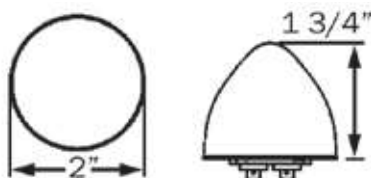

MCL21 SERIES
HOLE CUT-OUT: 2.313"

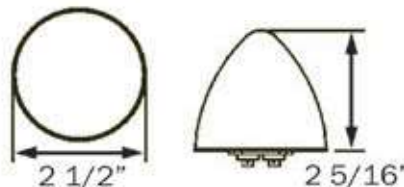

MCL23 SERIES
HOLE CUT-OUT: 2.75"

MCL155 SERIES GloLight® 2" Round Sealed LED Marker/Clearance Lights

GloLight®

SEALED LED MARKER/
CLEARANCE LIGHTS

PATENTED TECHNOLOGY

- Sonically sealed, waterproof
- Accepts standard two-pin PL-10 plug
- Recess grommet and flange mount models available

BULK P/N	POLYPACK P/N	DESCRIPTION	QTY
YELLOW - 6 DIODES			
MCL155AB	MCL155ABP	Grommet mount	20
MCL155AFB	MCL155AFBP	Flange mount	20
RED - 6 DIODES			
MCL155RB	MCL155RBP	Grommet mount	20
MCL155RFB	MCL155RFBP	Flange mount	20
ACCESSORIES			
A46PB	A46PBP	Straight PL-10 plug, 6" lead	100
A86PB	A86PBP	Straight PL-10 plug, 18" lead	100
A54GB	A54GBP	2" Flush mount grommet	100
A54GK	A54GKP	2" Kit: A54GB and A46PB	100
A55CB	A55CBP	2" Chrome trim ring	20
BK5557GB	BK5557GBP	Cam-on mounting bracket	50

FMVSS	P2
MATERIALS	Polycarbonate lens and housing
VOLT/AMP	12.8VDC - 0.06A
WT/DIMS	Grommet Mount: .066 lbs. / 2" x 2" x 1" Flange Mount: .078 lbs. / 2.938" x 2.938" x .938"
WARRANTY	Lifetime LED Warranty



MCL155AB



MCL155RB



MCL155AFB



MCL155RFB



MCL155AB/RB

HOLE CUT-OUT: 2.313"

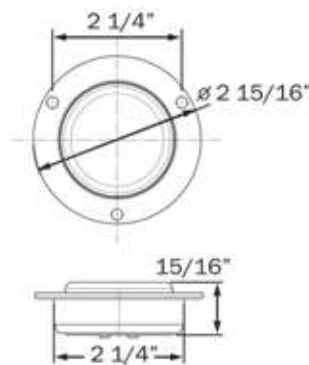

MCL155AFB/RFB

HOLE CUT-OUT: 2.313"



MCL55 SERIES 2" Round Sealed LED Marker/Clearance Lights

- Sonically sealed, waterproof
- Accepts standard two-pin PL-10 plug
- Available in 12V and 12-24V models



MCL55AB



MCL55RB

MCL55ACB
MCL55RCB
UCL55CB

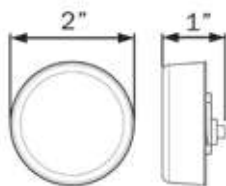

HOLE CUT-OUT: 2.313"



MCL55FRB

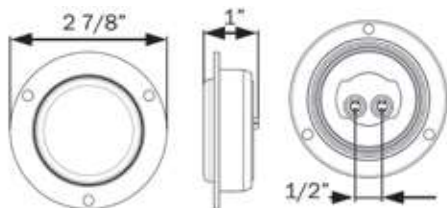

HOLE CUT-OUT: 2.313"

BULK P/N	POLYPACK P/N	DESCRIPTION	QTY
YELLOW - 3 DIODES			
MCL55AB	MCL55ABP	Grommet mount, 12V	20
MCL55ACB	MCL55ACBP	Clear lens grommet mount, 12V	20
MCL55A1224B	MCL55A1224BP	Grommet mount, 12-24V	20
MCL55AKB	MCL55AKBP	Kit with grommet and plug, 12V	20
RED - 3 DIODES			
MCL55RB	MCL55RBP	Grommet mount, 12V	20
MCL55RCB	MCL55RCBP	Clear lens grommet mount, 12V	20
MCL55R1224B	MCL55R1224BP	Grommet mount, 12-24V	20
MCL55RKB	MCL55RKBP	Kit with grommet and plug, 12V	20
MCL55FRB	MCL55FRBP	Flange mount, 12V	50
UTILITY LIGHT - 3 DIODES			
UCL55CB	UCL55CBP	White LED, 12V	20
ACCESSORIES			
A46PB	A46PBP	Straight PL-10 plug, 6" lead	100
A86PB	A86PBP	Straight PL-10 plug, 18" lead	100
A54GB	A54GBP	2" Flush mount grommet	100
A54GK	A54GKP	2" Kit: A54GB and A46PB	100
A55CB	A55CBP	2" Chrome trim ring	20
BK5557GB	BK5557GBP	Cam-on mounting bracket	50
RETAIL			
MCL55AK	Yellow kit with A54GB & A46PB, clam		12
MCL55RK	Red kit with A54GB & A46PB, clam		12

FMVSS	P2
MATERIALS	Polycarbonate lens and housing
VOLT/AMP	12.8VDC - 0.06A
WT/DIMS	MCL55: .066 lbs. / 2" x 2" x 1" MCL55FRB: .078 lbs. / 2.875" x 2.875" x 1"
WARRANTY	Lifetime LED Warranty

MCL505 SERIES 2" Round Sealed LED ABS Lights

- Sonically sealed, waterproof
- Accept standard two-pin PL-10 plugs
- Available in grommet and flange mount models
- MCL505GABSB includes A54GB grommet



MCL505ABS

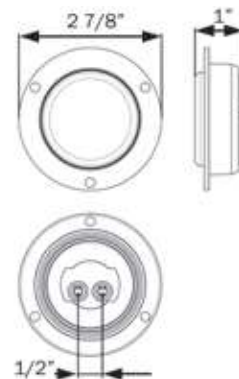

HOLE CUT-OUT: 2.313"

BULK P/N	POLYPACK P/N	DESCRIPTION	QTY
YELLOW - 3 DIODES			
MCL505ABS	MCL505ABS	Flange mount	50
MCL505GABS	MCL505GABS	Grommet mount kit, with A54GB grommet	20
ACCESSORIES			
A46PB	A46PBP	Straight PL-10 plug, 6" lead	100
A86PB	A86PBP	Straight PL-10 plug, 18" lead	100
A54GB	A54GBP	Standard flush mount grommet	100
A54GK	A54GKP	Kit: A54GB and A46PB	100
A55CB	A55CBP	Chrome trim ring	20
BK5557GB	BK5557GBP	Cam-on mounting bracket	50

FMVSS	P2
MATERIALS	Polycarbonate lens and housing
VOLT/AMP	12.8VDC - .047A
WT/DIMS	MCL505ABS: .078 lbs. / 2.875" x 2.875" x 1" MCL505GABS: .066 lbs. / 2" x 2" x 1"
WARRANTY	Lifetime LED Warranty



MCL505GABS

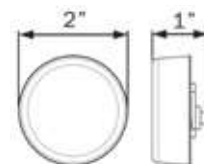

HOLE CUT-OUT: 2.313"

SEALED LED MARKER/
CLEARANCE LIGHTS



MCL56AB



MCL56AFB



MCL56RB



MCL56RFB

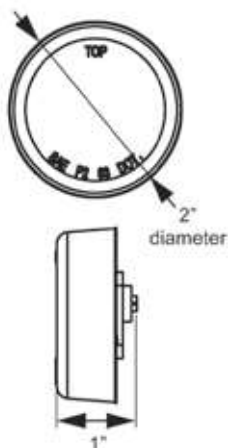

HOLE CUT-OUT: 2.313"

MCL56 SERIES

FLEET Count™ 2" Round Sealed LED Marker/Clearance Lights

- Sonically sealed, waterproof
- Accepts standard two-pin PL-10 plug
- Multiple mounting options available

BULK P/N	POLYPACK P/N	DESCRIPTION	QTY
YELLOW - 1 DIODE			
MCL56AB	MCL56ABP	Light only	20
MCL5AFB	MCL56AFBP	Flange mount	20
RED - 1 DIODE			
MCL56RB	MCL56RBP	Light only	20
MCL56RFB	MCL56RFBP	Flange mount	20
ACCESSORIES			
A46PB	A46PBP	Straight PL-10 plug, 6" lead	100
A86PB	A86PBP	Straight PL-10 plug, 18" lead	100
A54GB	A54GBP	2" Flush mount grommet	100
A54GK	A54GKP	2" Kit: A54GB and A46PB	100
A55CB	A55CBP	2" Chrome trim ring	20
BK5557GB	BK5557GBP	Cam-on mounting bracket	50
RETAIL			
MCL56AK		Yellow kit with A54GB & A46PB, clam	12
MCL56AS		Yellow light only, clam	12
MCL56RK		Red kit with A54GB & A46PB, clam	12
MCL56RS		Red light only, clam	12

FMVSS	P2
MATERIALS	Polycarbonate lens and housing
VOLT/AMP	12.8VDC - 0.045A
WT/DIMS	Grommet mount: .066 lbs. / 2" x 2" x 1" Flange mount: .071 lbs. / 2.938" x 2.938" x .938"
WARRANTY	Lifetime LED Warranty

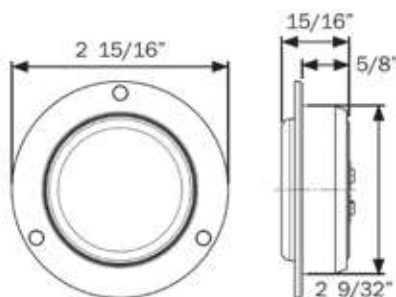

HOLE CUT-OUT: 2.313"

MCL52 REFLEX SERIES

2" Round Sealed LED Marker/Clearance Lights with Reflex Lens and Flange

- Recess flange mount
- Sonically sealed, waterproof
- Hard wired, includes separate ground wire
- Built-in reflex eliminates the need for a separate reflector

BULK P/N	POLYPACK P/N	DESCRIPTION	QTY
YELLOW - 7 DIODES			
MCL52AHXB	MCL52AHXBP	Reflex flange	50
RED - 7 DIODES			
MCL52RHXB	MCL52RHXP	Reflex flange	50

FMVSS	A P2
MATERIALS	Polycarbonate lens and housing
VOLT/AMP	12.8VDC - 0.063A
WT/DIMS	.088 lbs. / 3.063" x 3.063" x .813"
WARRANTY	Lifetime LED Warranty

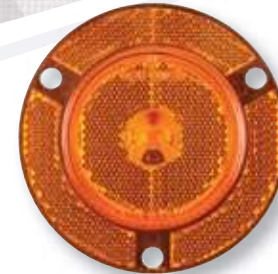

MCL52AHXB



MCL52RHXB

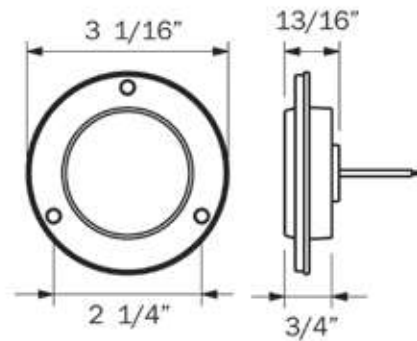

HOLE CUT-OUT: 2.313"

SEALED LED MARKER/
CLEARANCE LIGHTS



MCL50AB



MCL50RB



MCL50 SERIES

Miro-Flex™ 2" Round Sealed LED Marker/Clearance Lights

- Sonically sealed, waterproof
- Accepts standard two-pin PL-10 plug
- Multiple mounting options available

BULK P/N	POLYPACK P/N	DESCRIPTION	QTY
YELLOW - 9 DIODES			
MCL50AB	MCL50ABP	Light only	20
RED - 9 DIODES			
MCL50RB	MCL50RBP	Light only	20
ACCESSORIES			
A46PB	A46PBP	Straight PL-10 plug, 6" lead	100
A86PB	A86PBP	Straight PL-10 plug, 18" lead	100
A54GB	A54GBP	2" Flush mount grommet	100
A54GK	A54GKP	2" Kit: A54GB and A46PB	100
A55CB	A55CBP	2" Chrome trim ring	20
BK5557GB	BK5557GBP	Cam-on mounting bracket	50



HOLE CUT-OUT: 2.313"

FMVSS	P2
MATERIALS	Polycarbonate lens and housing
VOLT/AMP	12.8VDC - 0.047A
WT/DIMS	.088 lbs. / 2" x 2" x 1.188"
WARRANTY	Lifetime LED Warranty

MCL52/54 SERIES 2" Round Sealed LED Marker/Clearance Lights



- Sonically sealed, waterproof
- Available with standard PL-10 or optional weathertight connection
- PC rated: functions as both clearance and side marker light when properly mounted on a 45 degree angle
- Available in flange mount and grommet mount models



MCL54AB



MCL54RB

BULK P/N	POLYPACK P/N	DESCRIPTION	QTY
YELLOW - 5 DIODES			
MCL52AB	MCL52ABP	Flange mount, PL-10 connection	20
MCL52AMB	MCL52AMBP	Flange mount, weathertight connection; pigtail included	20
MCL54AB	MCL54ABP	Grommet mount, PL-10 connection	20
RED - 5 DIODES			
MCL52RB	MCL52RBP	Flange mount, PL-10 connection	20
MCL52RMB	MCL52RMBP	Flange mount, weathertight connection; pigtail included	20
MCL54RB	MCL54RBP	Grommet mount, PL-10 connection	20
ACCESSORIES			
A46PB	A46PBP	Straight PL-10 plug, 6" lead	100
A86PB	A86PBP	Straight PL-10 plug, 18" lead	100
AL42PB	AL42PBP	Weathertight pigtail	100
A54GB	A54GBP	2" Flush mount grommet	100
A54GK	A54GKP	2" Kit: A54GB and A46PB	100
A55CB	A55CBP	2" Chrome trim ring	20
BK5557GB	BK5557GBP	Cam-on mounting bracket	50
A52GB	-	Gasket for flange mount, black	100



MCL52AB



MCL52RB



detail of weathertight connection on MCL52AMB/RMB; pigtail included

FMVSS	P2 PC
MATERIALS	Polycarbonate lens and housing
VOLT/AMP	12.8VDC - 0.063A
WT/DIMS	Flange mount: .088 lbs. / 2.938" x 2.938" x 0.938" Grommet mount: .066 lbs. / 2.063" x 2.063" x 0.875"
WARRANTY	Lifetime LED Warranty

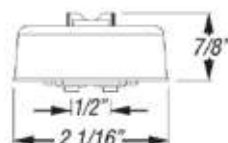

MCL54

HOLE CUT-OUT: 2.313"

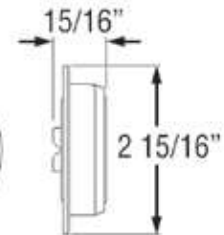
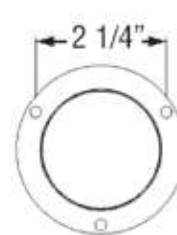

MCL52

HOLE CUT-OUT: 2.313"

SEALED LED MARKER/
CLEARANCE LIGHTS

GloLight

MCL157 SERIES GloLight® 2.5" Round Sealed LED Marker/Clearance Lights

PATENTED TECHNOLOGY

- Sonically sealed, waterproof
- Accepts standard two-pin PL-10 plug



MCL157AB



MCL157RB



BULK P/N	POLYPACK P/N	DESCRIPTION	QTY
YELLOW - 9 DIODES			
MCL157AB	MCL157ABP	Light only	20
RED - 9 DIODES			
MCL157RB	MCL157RBP	Light only	20
ACCESSORIES			
A46PB	A46PBP	Straight PL-10 plug, 6" lead	100
A86PB	A86PBP	Straight PL-10 plug, 18" lead	100
A55GB	A55GBP	Flush mount grommet (open back)	50
A56GB	A56GBP	Recess mount grommet (closed back)	100
A57GB	A57GBP	Recess mount grommet (open back)	50
A55GK	A55GKP	Kit: A55GB and A46PB	100
A57GK	A57GKP	Kit: A57GB and A46PB	100
A57CB	A57CBP	Chrome trim ring	20
BK5557GB	BK5557GBP	Cam-on mounting bracket	50

FMVSS	P2
MATERIALS	Polycarbonate lens and housing
VOLT/AMP	12.8VDC - 0.099A
WT/DIMS	.132 lbs. / 2.5" x 2.5" x 1.125"
WARRANTY	Lifetime LED Warranty

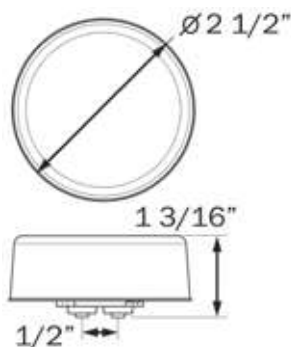

HOLE CUT-OUT: 2.75"

MCL57 SERIES 2.5" Round Sealed LED Marker/Clearance Lights

- Sonically sealed, waterproof
- Accepts standard two-pin PL-10 plug
- Available in 12V and 24V models



SEALED LED MARKER/
CLEARANCE LIGHTS

BULK P/N	POLYPACK P/N	DESCRIPTION	QTY
YELLOW - 3 DIODES			
MCL57AB	MCL57ABP	Light only, 12V	20
MCL57A24B	MCL57A24BP	Light only, 24V	20
MCL57ACB	MCL57ACBP	Clear lens light only, 12V	20
MCL57AKB	MCL57AKBP	Kit with grommet and plug	20
RED - 3 DIODES			
MCL57RB	MCL57RBP	Light only, 12V	20
MCL57R1224B	MCL57R1224BP	Light only, 12-24V	20
MCL57R24B	MCL57R24BP	Light only, 24V	20
MCL57RCB	MCL57RCBP	Clear lens light only, 12V	20
MCL57RKB	MCL57RKBP	Kit with grommet and plug	20
ACCESSORIES			
A46PB	A46PBP	Straight PL-10 plug, 6" lead	100
A86PB	A86PBP	Straight PL-10 plug, 18" lead	100
A55GB	A55GBP	Flush mount grommet (open back)	50
A56GB	A56GBP	Recess mount grommet (closed back)	100
A57GB	A57GBP	Recess mount grommet (open back)	50
A55GK	A55GKP	Kit: A55GB and A46PB	100
A57GK	A57GKP	Kit: A57GB and A46PB	100
A57CB	A57CBP	Chrome trim ring	20
BK5557GB	BK5557GBP	Cam-on mounting bracket	50
RETAIL			
MCL57AK		Yellow kit with A55GB & A46PB, clam	12
MCL57RK		Red kit with A55GB & A46PB, clam	12

FMVSS	P2
MATERIALS	Polycarbonate lens and housing
VOLT/AMP	12.8VDC - 0.096A
WT/DIMS	.132 lbs. / 2.5" x 2.5" x 1"
WARRANTY	Lifetime LED Warranty



MCL57AB



MCL57RB



MCL57ACB/RCB

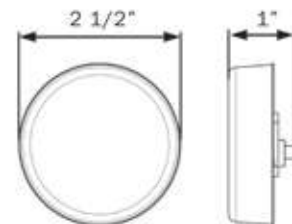

HOLE CUT-OUT: 2.75"



MCL527 SERIES

FLEET Count™ 2.5" Round Sealed LED Marker/Clearance Lights

- Sonically sealed, waterproof
- Accepts standard two-pin PL-10 plug
- Multiple mounting options available



MCL527AB



MCL527AFB



MCL527RB



MCL527RFB

BULK P/N	POLYPACK P/N	DESCRIPTION	QTY
YELLOW - 2 DIODES			
MCL527AB	MCL527ABP	Light only	20
MCL527AFB	MCL527AFBP	Flange mount	20
RED - 2 DIODES			
MCL527RB	MCL527RBP	Light only	20
MCL527RFB	MCL527RFBP	Flange mount	20
ACCESSORIES			
A46PB	A46PBP	Straight PL-10 plug, 6" lead	100
A86PB	A86PBP	Straight PL-10 plug, 18" lead	100
A55GB	A55GBP	Flush mount grommet (open back)	50
A56GB	A56GBP	Recess mount grommet (closed back)	100
A57GB	A57GBP	Recess mount grommet (open back)	50
A55GK	A55GKP	Kit: A55GB and A46PB	100
A57GK	A57GKP	Kit: A57GB and A46PB	100
A57CB	A57CBP	Chrome trim ring	20
BK5557GB	BK5557GBP	Cam-on mounting bracket	50
RETAIL			
MCL527AK		Yellow kit with A57GB & A46PB, clam	12
MCL527AS		Yellow light only, clam	12
MCL527RK		Red kit with A57GB & A46PB, clam	12
MCL527RS		Red light only, clam	12

FMVSS	P2
MATERIALS	Polycarbonate lens and housing
VOLT/AMP	12.8VDC - 0.034A
WT/DIMS	Grommet Mount: .088 lbs. / 2.5" x 2.5" x 1.063" Flange Mount: .088lbs. / 3.438" x 3.438" x .938"
WARRANTY	Lifetime LED Warranty

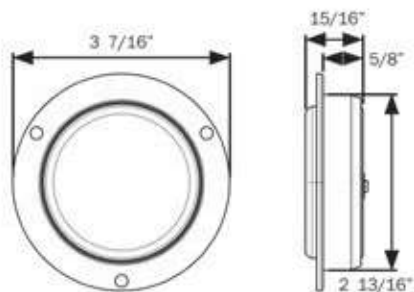

HOLE CUT-OUT: 2.75"

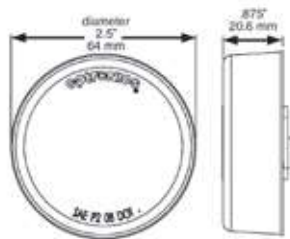

HOLE CUT-OUT: 2.75"

MCL51 SERIES

Miro-Flex™ 2.5" Round Sealed LED Marker/Clearance Lights

- Sonically sealed, waterproof
- Accepts standard two-pin PL-10 plug
- Multiple mounting options available

BULK P/N	POLYPACK P/N	DESCRIPTION	QTY
YELLOW - 3 DIODES			
MCL51AB	MCL51ABP	Light only	20
RED - 3 DIODES			
MCL51RB	MCL51RBP	Light only	20
ACCESSORIES			
A46PB	A46PBP	Straight PL-10 plug, 6" lead	100
A86PB	A86PBP	Straight PL-10 plug, 18" lead	100
A55GB	A55GBP	Flush mount grommet (open back)	50
A56GB	A56GBP	Recess mount grommet (closed back)	100
A57GB	A57GBP	Recess mount grommet (open back)	50
A55GK	A55GKP	Kit: A55GB and A46PB	100
A57GK	A57GKP	Kit: A57GB and A46PB	100
A57CB	A57CBP	Chrome trim ring	20
BK5557GB	BK5557GBP	Cam-on mounting bracket	50

FMVSS	P2
MATERIALS	Polycarbonate lens and housing
VOLT/AMP	12.8VDC - 0.033A
WT/DIMS	.088 lbs. / 2.5" x 2.5" x 1.188"
WARRANTY	Lifetime LED Warranty



MCL51AB



MCL51RB

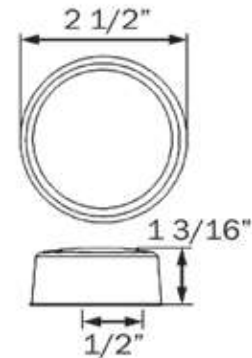

HOLE CUT-OUT: 2.75"

SEALED LED MARKER/
CLEARANCE LIGHTS



MCL58 SERIES 2.5" Round Sealed LED Marker/Clearance Lights



MCL58AB



MCL58ACB

MCL58RB



MCL58AMFB



MCL58RMFB

- Sonically sealed, waterproof
- Available with standard PL-10 or optional weathertight connection
- Multiple mounting options available
- PC rated: functions as both clearance and side marker light when properly mounted on a 45 degree angle

BULK P/N	POLYPACK P/N	DESCRIPTION	QTY
----------	--------------	-------------	-----

YELLOW - 7 DIODES

MCL58AB	MCL58ABP	Light only	20
MCL58ACB	MCL58ACBP	Clear lens, yellow diodes, light only	20
MCL58AMFB	MCL58AMFBP	Flange mount, weathertight connection	50

RED - 7 DIODES

MCL58RB	MCL58RBP	Light only	20
MCL58RMFB	MCL58RMFBP	Flange mount, weathertight connection	50

ACCESSORIES

A46PB	A46PBP	Straight PL-10 plug, 6" lead	100
A86PB	A86PBP	Straight PL-10 plug, 18" lead	100
AL42PB	AL42PBP	Weathertight pigtail	100
A55GB	A55GBP	Flush mount grommet (open back)	50
A56GB	A56GBP	Recess mount grommet (closed back)	100
A57GB	A57GBP	Recess mount grommet (open back)	50
A55GK	A55GKP	Kit: A55GB and A46PB	100
A57GK	A57GKP	Kit: A57GB and A46PB	100
A57CB	A57CBP	Chrome trim ring	20
BK5557GB	BK5557GBP	Cam-on mounting bracket	50

FMVSS	P2 PC
MATERIALS	Polycarbonate lens and housing
VOLT/AMP	12.8VDC - 0.057A
WT/DIMS	Grommet Mount: .132 lbs. / 2.5" x 2.5" x 0.938" Flange Mount: .112lbs. / 3.42" x 3.42" x 1.30"
WARRANTY	Lifetime LED Warranty



detail of
weathertight connection;

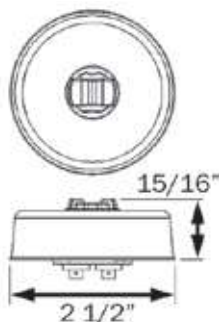

HOLE CUT-OUT: 2.75"

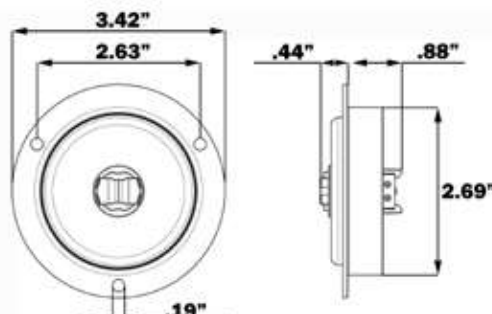

HOLE CUT-OUT: 2.75"

MCL59 SERIES

2.5" Round Sealed LED Marker/ Clearance Lights with Reflex

- Sonically sealed, waterproof
- Accepts standard two-pin PL-10 plug
- Multiple mounting options available
- Built-in reflex eliminates the need for a separate reflector

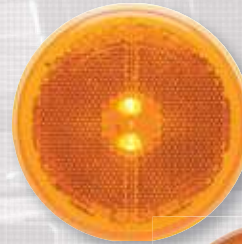

MCL59AB



MCL59RB



SEALED LED MARKER/
CLEARANCE LIGHTS

BULK P/N	POLYPACK P/N	DESCRIPTION	QTY
YELLOW - 8 DIODES			
MCL59AB	MCL59ABP	Light only	20
RED - 8 DIODES			
MCL59RB	MCL59RBP	Light only	20
ACCESSORIES			
A46PB	A46PBP	Straight PL-10 plug, 6" lead	100
A86PB	A86PBP	Straight PL-10 plug, 18" lead	100
A55GB	A55GBP	Flush mount grommet (open back)	50
A56GB	A56GBP	Recess mount grommet (closed back)	100
A57GB	A57GBP	Recess mount grommet (open back)	50
A55GK	A55GKP	Kit: A55GB and A46PB	100
A57GK	A57GKP	Kit: A57GB and A46PB	100
A57CB	A57CBP	Chrome trim ring	20
BK5557GB	BK5557GBP	Cam-on mounting bracket	50

FMVSS	A P2
MATERIALS	Polycarbonate lens and housing
VOLT/AMP	12.8VDC - 0.047A
WT/DIMS	.088 lbs. / 2.5" x 2.5" x 1.063"
WARRANTY	Lifetime LED Warranty

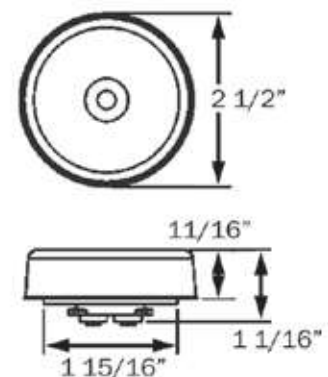

HOLE CUT-OUT: 2.75"

GloLight®

MCL190 SERIES GloLight® Mini Thinline Sealed LED Marker/Clearance Lights



MCL190AB



MCL190RB

PATENTED TECHNOLOGY

- Sonically sealed, waterproof
- Hard wired with female PL-10 plug on 5" leads
- Includes both lead and ground wire for mounting to all surfaces

BULK P/N	POLYPACK P/N	DESCRIPTION	QTY
YELLOW - 8 DIODES			
MCL190AB	MCL190ABP	Kit with chrome base, female PL-10 plug	50
RED - 8 DIODES			
MCL190RB	MCL190RBP	Kit with chrome base, female PL-10 plug	50

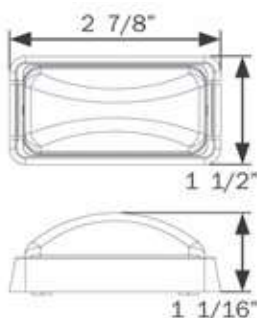

FMVSS	P2
MATERIALS	Polycarbonate lens and housing
VOLT/AMP	12.8VDC - 0.16A
WT/DIMS	.044 lbs. / 2.625" x 1.25" x .875"
WARRANTY	Lifetime LED Warranty

AL91 SERIES Mini Thinline Sealed LED Marker/Clearance Lights



- Sonically sealed, waterproof
- Standard models accept standard 1- or 2-wire plugs
- Hard wired design available in 1- and 2-wire models
- Single wire design grounds through mounting hardware
- Two-wire design includes both lead and ground wire for mounting to all surfaces
- PC rated light functions as both clearance and side marker light when properly mounted on a 45 degree angle



AL91AB



AL91RB

BULK P/N	POLYPACK P/N	DESCRIPTION	QTY
YELLOW - 3 DIODES			
AL91AB	AL91ABP	PC rated	50
AL91CAB	AL91CABP	PC rated, clear lens	50
MCL91AB	MCL91ABP	Kit: AL91AB, A91CB & A91LW	50
AL82AB	AL82ABP	PC rated, hard wired, 2-wire	50
MCL96AB	MCL96ABP	P2 rated kit, hard wired, 1-wire, A91BB base	50
RED - 3 DIODES			
AL91RB	AL91RBP	PC rated	50
MCL91RB	MCL91RBP	Kit: AL91RB, A91CB & A91LW	50
AL82RB	AL82RBP	PC rated, hard wired, 2-wire	50
MCL96RB	MCL96RBP	P2 rated kit, hard wired, 1-wire, A91BB base	50
ACCESSORIES			
A46PB	A46PBP	2-wire PL-10 plug, 6" lead	100
A86PB	A86PBP	2-wire PL-10 plug, 18" lead	100
A91LW	A91LWP	1-wire plug, 12" lead	100
A91BB	A91BBP	Black base, self grounding	100
A91BOB	A91BOBP	Black base, open back	100
A91CB	A91CBP	Chrome base, self grounding	100
A91OB	A91OBP	Chrome base, open back	100
A91GB	A91GBP	Grommet	100
RETAIL			
MCL91AK		Yellow P2 kit with A91CB & A91LW, clam	12
MCL90AS		Yellow P2 light only, clam	12
MCL91RK		Red P2 kit with A91CB & A91LW, clam	12
MCL90RS		Red P2 light only, clam	12

FMVSS	PC (unless noted)
MATERIALS	Polycarbonate lens and housing
VOLT/AMP	12.8VDC - 0.051A
WT/DIMS	.088 lbs. 2.5" x 1.25" x 1"
WARRANTY	Lifetime LED Warranty

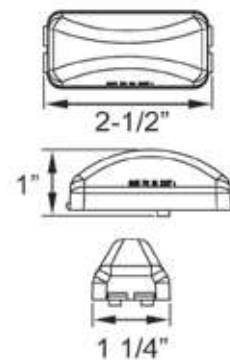

SEALED LED MARKER/
CLEARANCE LIGHTS



AL90AB



AL90RB

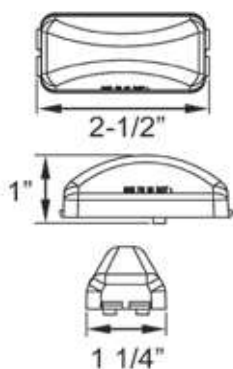

AL90 SERIES

FLEET Count™ Mini Thinline Sealed LED Marker/Clearance Light

- Sonically sealed, waterproof
- Accept standard 1- or 2-wire plugs
- Single wire design grounds through mounting hardware
- Two-wire design includes both lead and ground wire for mounting to all surfaces

BULK P/N	POLYPACK P/N	DESCRIPTION	QTY
YELLOW - 1 DIODE			
AL90AB	AL90ABP	Light only	50
RED - 1 DIODE			
AL90RB	AL90RBP	Light only	50
AL90RCB	AL90RCBP	Clear lens, red diode, light only	50
ACCESSORIES			
A46PB	A46PBP	2-wire PL-10 plug, 6" lead	100
A86PB	A86PBP	2-wire PL-10 plug, 18" lead	100
A91LW	A91LWP	1-wire plug, 12" lead	100
A91BB	A91BBP	Black base, self grounding	100
A91BOB	A91BOBP	Black base, open back	100
A91CB	A91CBP	Chrome base, self grounding	100
A91OB	A91OBP	Chrome base, open back	100
A91GB	A91GBP	Grommet	100
RETAIL			
AL90AK		Yellow kit with A91BB & A91LW, clam	12
AL90AS		Yellow light only, clam	12
AL90RK		Red kit with A91BB & A91LW, clam	12
AL90RS		Red light only, clam	12

FMVSS	P2
MATERIALS	Polycarbonate lens and housing
VOLT/AMP	12.8VDC - 0.023A
WT/DIMS	.044 lbs. / 2.5" x 1.25" x 1"
WARRANTY	Lifetime LED Warranty

MCL165 SERIES GloLight® Thinline Sealed LED Marker/Clearance Lights

GloLight®

SEALED LED MARKER/
CLEARANCE LIGHTS

PATENTED TECHNOLOGY

- Sonically sealed, waterproof
- Accept standard 1- or 2-wire plugs
- Single wire design grounds through mounting hardware
- Two-wire design includes both lead and ground wire for mounting to all surfaces

BULK P/N	POLYPACK P/N	DESCRIPTION	QTY
YELLOW - 10 DIODES			
MCL165AB	MCL165ABP	Light only	20
RED - 10 DIODES			
MCL165RB	MCL165RBP	Light only	20
ACCESSORIES			
A65B	A65BP	Black bracket	50
A65P	A65PP	Single wire plug, .156 male bullet	50
A65PB	A65PBP	Kit: A65B black bracket & A65P plug	50
A66PB	A66PBP	Kit: Gray bracket & A65P plug	50
A67CB	A67CBP	Kit: Chrome bracket & A65P plug	50
A68PB	A68PBP	Kit: Black bracket & 2-wire plug	50

For more details on mounting and wiring accessories, see Accessories section at back of catalog.

FMVSS	P2
MATERIALS	Polycarbonate lens and housing
VOLT/AMP	12.8VDC - 0.07A
WT/DIMS	.066 lbs. / 3.875" x 1.25" x 1"
WARRANTY	Lifetime LED Warranty



MCL165AB



MCL165RB

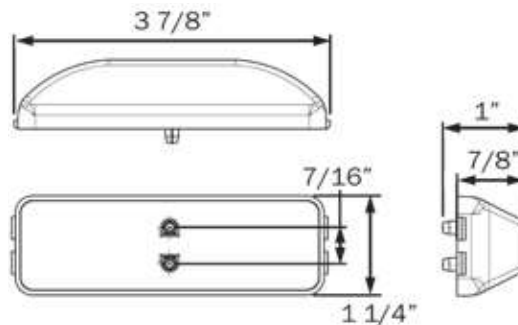



MCL65 SERIES Thinline Sealed LED Marker/Clearance Lights

- Sonically sealed, waterproof
- Accept standard 1- or 2-wire plugs
- Single wire design grounds through mounting hardware
- Two-wire design includes both lead and ground wire for mounting to all surfaces



MCL65AB



MCL65CAB



MCL65CRB



MCL65RB

BULK P/N	POLYPACK P/N	DESCRIPTION	QTY
YELLOW			
MCL65AB	MCL65ABP	12V, 3 diodes	20
MCL65A24B	MCL65A24BP	24V, 3 diodes	20
MCL65CAB	MCL65CABP	12V, 3 diodes, clear lens	20
MCL67AB	MCL67ABP	12V, 3 diodes, kit with A65PB	20
MCL75AB	MCL75ABP	12V, 4 diodes	20
MCL77AB	MCL77ABP	12V, 4 diodes, kit with A65PB	20
RED			
MCL65RB	MCL65RBP	12V, 3 diodes	20
MCL65R24B	MCL65R24BP	24V, 3 diodes	20
MCL65CRB	MCL65CRBP	12V, 3 diodes, clear lens	20
MCL67RB	MCL67RBP	12V, 3 diodes, kit with A65PB	20
MCL75RB	MCL75RBP	12V, 4 diodes	20
MCL77RB	MCL77RBP	12V, 4 diodes, kit with A65PB	20
ACCESSORIES			
A65B	A65BP	Black bracket	50
A65P	A65PP	Single wire plug, .156 male bullet	50
A65PB	A65PBP	Kit: A65B black bracket & A65P plug	50
A66PB	A66PBP	Kit: Gray bracket & A65P plug	50
A67CB	A67CBP	Kit: Chrome bracket & A65P plug	50
A68PB	A68PBP	Kit: Black bracket & 2-wire plug	50

For more details on mounting and wiring accessories, see Accessories section at back of catalog.

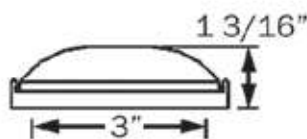
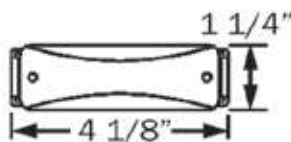

FMVSS	P2
MATERIALS	Polycarbonate lens and housing
VOLT/AMP	12.8VDC - 0.048A
WT/DIMS	.066 lbs. / 3.938" x 1.25" x 1.25"
WARRANTY	Lifetime LED Warranty

MCL61 SERIES FLEET Count™ Thinline Sealed LED Marker/Clearance Lights



- Sonically sealed, waterproof
- Accept standard 1- or 2-wire plugs
- Single wire design grounds through mounting hardware
- Two-wire design includes both lead and ground wire for mounting to all surfaces

BULK P/N	POLYPACK P/N	DESCRIPTION	QTY
YELLOW - 2 DIODES			
MCL61AB	MCL61ABP	Light only	20
RED - 2 DIODES			
MCL61RB	MCL61RBP	Light only	20
ACCESSORIES			
A65B	A65BP	Black bracket	50
A65P	A65PP	Single wire plug, .156 male bullet	50
A65PB	A65PBP	Kit: A65B black bracket & A65P plug	50
A66PB	A66PBP	Kit: Gray bracket & A65P plug	50
A67CB	A67CBP	Kit: Chrome bracket & A65P plug	50
A68PB	A68PBP	Kit: Black bracket & 2-wire plug	50
For more details on mounting and wiring accessories, see Accessories section at back of catalog.			
RETAIL			
MCL61AK		Yellow kit with A65PB, clam	12
MCL61AS		Yellow light only, clam	12
MCL61RK		Red kit with A65PB, clam	12
MCL61RS		Red light only, clam	12

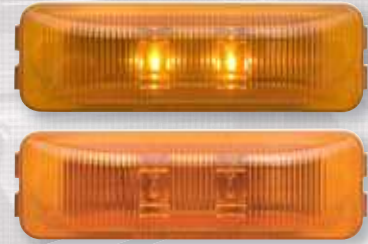

MCL61AB



MCL61RB

SEALED LED MARKER/
CLEARANCE LIGHTS

FMVSS	P2
MATERIALS	Polycarbonate lens and housing
VOLT/AMP	12.8VDC - 0.051A
WT/DIMS	.066 lbs. / 4" x 1.25" x 1"
WARRANTY	Lifetime LED Warranty

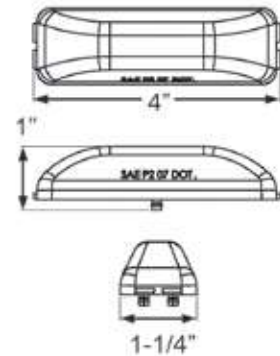



MCL63 SERIES

Miro-Flex™ Thinline Sealed LED Marker/Clearance Lights

- Sonically sealed, waterproof
- Accept standard 1- or 2-wire plugs
- Single wire design grounds through mounting hardware
- Two-wire design includes both lead and ground wire for mounting to all surfaces



MCL63AB



MCL63CAB



MCL63CRB



MCL63RB



BULK P/N	POLYPACK P/N	DESCRIPTION	QTY
YELLOW - 4 DIODES			
MCL63AB	MCL63ABP	Light only	20
MCL63CAB	MCL63CABP	Light only, clear lens	20
RED - 4 DIODES			
MCL63RB	MCL63RBP	Light only	20
MCL63CRB	MCL63CRBP	Light only, clear lens	20
ACCESSORIES			
A65B	A65BP	Black bracket	50
A65P	A65PP	Single wire plug, .156 male bullet	50
A65PB	A65PBP	Kit: A65B black bracket & A65P plug	50
A66PB	A66PBP	Kit: Gray bracket & A65P plug	50
A67CB	A67CBP	Kit: Chrome bracket & A65P plug	50
A68PB	A68PBP	Kit: Black bracket & 2-wire plug	50

For more details on mounting and wiring accessories, see Accessories section at back of catalog.

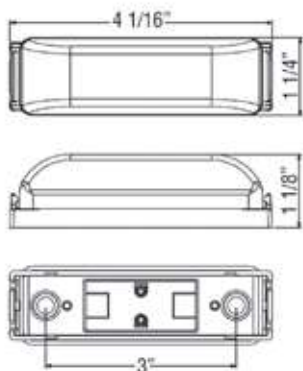

FMVSS	P2
MATERIALS	Polycarbonate lens and housing
VOLT/AMP	12.8VDC - 0.051A
WT/DIMS	.066 lbs. / 4" x 1.25" x 1"
WARRANTY	Lifetime LED Warranty

MCL61/65 SERIES

Thinline Sealed LED Fender Lights

- Sonically sealed, waterproof
- Accept standard 1- or 2-wire plugs
- Single wire design grounds through mounting hardware
- Two-wire design includes both lead and ground wire for mounting to all surfaces

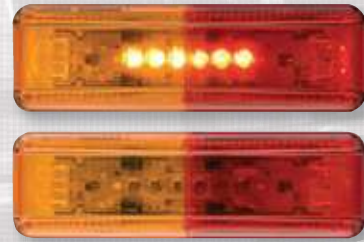

MCL65ARB

BULK P/N	POLYPACK P/N	DESCRIPTION	QTY
DUAL RED/YELLOW - 10 DIODES			
MCL65ARB	MCL65ARBP	Light only	20
MCL65CARB	MCL65CARBP	Light only, clear lens	20
MCL67ARB	MCL67ARBP	Kit with A65PB bracket & plug	20
DUAL RED/YELLOW - 2 DIODES			
MCL61ARB	MCL61ARBP	Light only	20
MCL61AR26BK	MCL61AR26BKP	Kit with A67BB black base & 26" power wire with .150 male bullet	20
ACCESSORIES			
A67BB	A67BBP	Black fender bracket	50
A67GB	A67GBP	Gray fender bracket	50
A67CVB	A67CVBP	Curved fender bracket, gray	50
A65B	A65BP	Black bracket	50
A65P	A65PP	Single wire plug, .156 male bullet	50
A65PB	A65PBP	Kit: A65B black bracket & A65P plug	50
A66PB	A66PBP	Kit: Gray bracket & A65P plug	50
A67CB	A67CBP	Kit: Chrome bracket & A65P plug	50
A68PB	A68PBP	Kit: Black bracket & 2-wire plug	50

For more details on mounting and wiring accessories, see Accessories section at back of catalog.

FMVSS	P2
MATERIALS	Polycarbonate lens and housing
VOLT/AMP	12.8VDC - 0.048A
WT/DIMS	.066 lbs. / 3.875" x 1.25" x 0.875"
WARRANTY	Lifetime LED Warranty



MCL61ARB

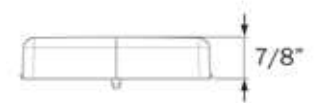
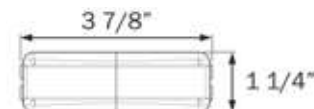

light only

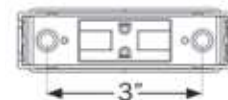
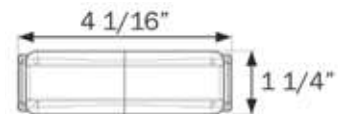

light with base



A67BB

SEALED LED MARKER/
CLEARANCE LIGHTS



MCL180 SERIES LED Fender Light Assembly

- Reversible - one product can be used for either driver or passenger side of trailer
- Sonically sealed, waterproof
- P2 rated
- Hard wired, includes separate ground wire



BULK P/N	POLYPACK P/N	DESCRIPTION	QTY
FENDER LIGHT - 2 DIODES			
MCL180ARB	MCL180ARBP	Amber/red, reversible	50

FMVSS	P2
MATERIALS	Polycarbonate lens and housing
VOLT/AMP	12.8VDC - .033A
WT/DIMS	.05 lbs. / 8.50" x 1.688" x .813"
WARRANTY	Lifetime LED Warranty

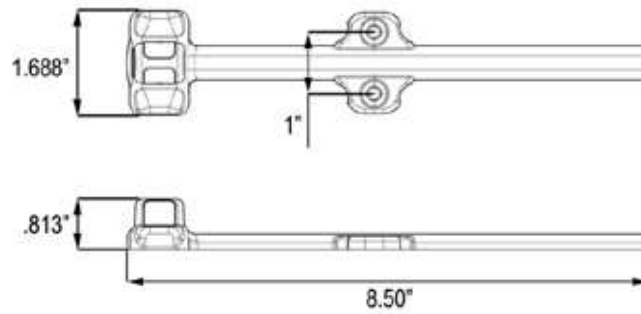

MCL99 SERIES Mini Sealed LED Horizontal-Vertical Marker/Clearance Lights

- Sealed, waterproof design
- Surface mount installation at either horizontal or vertical
- Single wire design grounds through mounting hardware
- Two-wire design includes both lead and ground wire for mounting to all surfaces



SURFACE MOUNT LED
MARKER/CLEARANCE LIGHTS



MCL99AB/A1B



MCL99RB/R1B



MCL99AC1B



MCL99RC1B

BULK P/N	POLYPACK P/N	DESCRIPTION	QTY
YELLOW - 1 DIODE			
MCL99AB	MCL99ABP	2-wire	20
MCL99A1B	MCL99A1BP	Single wire, self-grounding	20
MCL99AC1B	MCL99AC1BP	Clear lens, single wire, self-grounding	50
RED - 1 DIODE			
MCL99RB	MCL99RBP	2-wire	20
MCL99R1B	MCL99R1BP	Single wire, self grounding	20
MCL99RC1B	MCL99RC1BP	Clear lens, single wire, self-grounding	50

FMVSS	P2
MATERIALS	Polycarbonate lens and housing
VOLT/AMP	12.8VDC - .06A
WT/DIMS	.088 lbs. / 2.5" x 1.125" x 0.625"
WARRANTY	Lifetime LED Warranty

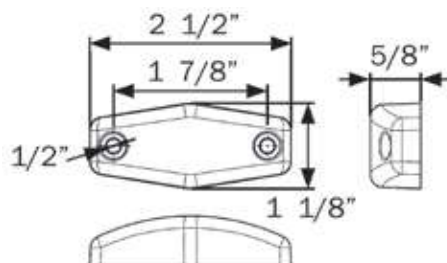



MCL13 SERIES Mini Sealed LED Marker/Clearance Lights



MCL13A2B



MCL13CA2B



MCL13CR2B



MCL13R2B



MCL13CA3B



MCL13CR3B

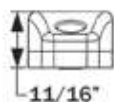
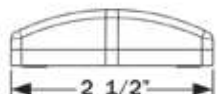
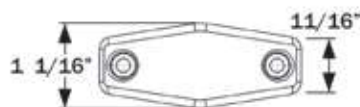

- Sonically sealed, waterproof
- Surface mount installation
- Single wire design grounds through mounting hardware
- Two-wire design includes both lead and ground wire for mounting to all surfaces
- Available in red, yellow, and clear utility light

BULK P/N	POLYPACK P/N	DESCRIPTION	QTY
YELLOW - 2 DIODES			
MCL13A2B	MCL13A2BP	2-wire	20
MCL13CA2B	MCL13CA2BP	2-wire, clear lens	20
MCL13CA3B	MCL13CA3BP	2-wire, clear lens, no base	50
MCL13A2MB	MCL13A2MBP	2-wire, .156 male bullets	20
MCL13APG	MCL13APGP	2-wire, 12" leads, .156 male bullets	20
MCL13A2PG	MCL13A2PGP	2-wire, .180 male bullets	20
MCL131A2B	MCL131A2BP	1-wire	20
MCL131CA2B	MCL131CA2BP	1-wire, clear lens	20
RED - 2 DIODES			
MCL13R2B	MCL13R2BP	2-wire	20
MCL13CR2B	MCL13CR2BP	2-wire, clear lens	20
MCL13CR3B	MCL13CR3BP	2-wire, clear lens, no base	50
MCL13R2MB	MCL13R2MBP	2-wire, .156 male bullets	20
MCL13R2PG	MCL13R2PGP	2-wire, .180 male bullets	20
MCL131R2B	MCL131R2BP	1-wire	20
MCL131CR2B	MCL131CR2BP	1-wire, clear lens	20
UTILITY LIGHTS - 2 DIODES			
UCL13C2PG	UCL13C2PGP	White LED 2-wire, .180 female barrels	20
ACCESSORIES			
A13C2B	A13C2BP	Chrome base/bezel	100
A13B2B	A13B2BP	Black base/bezel	100
A13G2B	A13G2BP	Gasket	200
RETAIL			
MCL13ATRS		Yellow, 2-wire, chrome bezel	12
MCL13AS		Yellow 2-wire light only	12
MCL13RTRS		Red, 2-wire, chrome bezel	12
MCL13RS		Red 2-wire light only	12
FMVSS	P2 P3 (except UCL13)		
MATERIALS	Polycarbonate lens and housing		
VOLT/AMP	12.8VDC - 0.046A		
WT/DIMS	.088 lbs. / 2.5" x 1.063" x 0.688" (models with no base .625" H)		
WARRANTY	Lifetime LED Warranty		

MCL14 SERIES

Mini Sealed LED Horizontal-Vertical Marker/Clearance Lights



- Sonically sealed, waterproof
- Surface mount installation at either horizontal or vertical
- Single wire design grounds through mounting hardware
- Two-wire design includes both lead and ground wire for mounting to all surfaces
- Available in red, yellow, and clear lens



SURFACE MOUNT LED MARKER/CLEARANCE LIGHTS



MCL14AB

MCL14CABF



MCL14CRBF



MCL14 clear lens, unlit



MCL14RB

BULK P/N	POLYPACK P/N	DESCRIPTION	QTY
YELLOW - 3 DIODES			
MCL14AB	MCL14ABP	2-wire	20
MCL14ABF	MCL14ABFP	2-wire, female plug	20
MCL14AGB	MCL14AGBP	1-wire, self grounding	20
MCL14AGPB	MCL14AGPBP	1-wire, .180 male bullet	20
MCL14CABF	MCL14CABFP	Clear lens, 2-wire, .156 female barrels	20
MCL14A12GB	MCL14A12GBP	1-wire, 12" lead	20
RED - 3 DIODES			
MCL14RB	MCL14RBP	2-wire	20
MCL14RBF	MCL14RBF	2-wire, female plug	20
MCL14RGB	MCL14RGBP	1-wire, self grounding	20
MCL14CRBF	MCL14CRBFP	Clear lens, 2-wire, .156 female barrels	20
MCL14RPG	MCL14RPGP	2-wire, 12" leads, .156 male bullets	20
ACCESSORIES			
A13C2B	A13C2BP	Chrome base/bezel	100
A13B2B	A13B2BP	Black base/bezel	100
A13G2B	A13G2BP	Gasket	200

FMVSS	P2 PC
MATERIALS	Polycarbonate lens and housing
VOLT/AMP	12.8VDC - 0.06A
WT/DIMS	.088 lbs. / 2.5" x 1.125" x 0.625"
WARRANTY	Lifetime LED Warranty

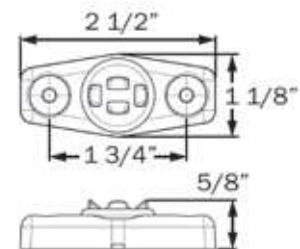

A13C2B



MCL15 SERIES Surface Mount LED Marker/Clearance Lights

- Sonically sealed, waterproof
- Surface mount installation
- Hard wired, includes both lead and ground wire with molded .180 male bullets
- Chrome finish ABS trim ring included with kits



MCL15APG



MCL15AKPG



MCL15RPG



MCL15RKPG

BULK P/N	POLYPACK P/N	DESCRIPTION	QTY
YELLOW - 2 DIODES			
MCL15APG	MCL15APGP	Light only, .180 male bullets	20
MCL15AKPG	MCL15AKPGP	Kit: MCL15APG, chrome trim ring	20
RED - 2 DIODES			
MCL15RPG	MCL15RPGP	Light only, .180 male bullets	20
MCL15RKPG	MCL15RKPGP	Kit: MCL15RPG, chrome trim ring	20
ACCESSORIES			
A15CB	A15CBP	Chrome base/bezel	100
A15BB	A15BBP	Black base/bezel	100
A15GB	A15GBP	Gasket	50

FMVSS	P2
MATERIALS	Polycarbonate lens and housing, ABS trim ring
VOLT/AMP	12.8VDC - 0.047A
WT/DIMS	Light: .088 lbs. / 2.625" x 1.375" x .563" Kit: .092 lbs. / 3.938" x 1.344" x .688"
WARRANTY	Lifetime LED Warranty

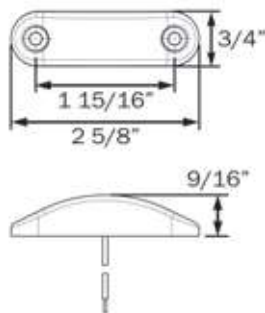

MCL15APG/RPG

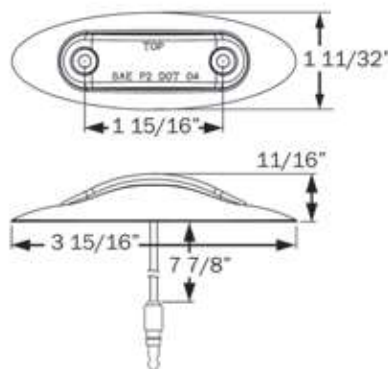

MCL15AKPG/RKPG

MCL299 SERIES Sealed LED Marker/Clearance Light

- Sonically sealed, waterproof
- Adhesive mount
- Hard wired, includes separate ground wire



MCL299AB



MCL299RB

BULK P/N	POLYPACK P/N	DESCRIPTION	QTY
YELLOW - 1 DIODE			
MCL299AB	MCL299ABP	Light only	50
RED - 1 DIODE			
MCL299RB	MCL299RBP	Light only	50

FMVSS	PC
MATERIALS	Polycarbonate lens and housing
VOLT/AMP	Yellow: 12.8VDC - 0.12A Red: 12.8V - 0.065A
WT/DIMS	.03 lbs. / 1.50" x .625" x .75"
WARRANTY	Lifetime LED Warranty

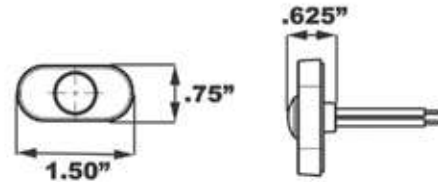



MCL17/19 SERIES

Miro-Flex™ Surface Mount Sealed LED Marker/Clearance Lights

- Sonically sealed, waterproof
- Two-wire design includes both lead and ground wire for mounting to all surfaces
- Snap-on chrome trim ring included
- Available in 3-LED 4" model and 4-LED 6" model



MCL17AB



MCL17CAB/CRB



MCL17RB



MCL19AB



MCL19CAB/CRB



MCL19RB



A17GB

BULK P/N	POLYPACK P/N	DESCRIPTION	QTY
YELLOW			
MCL17AB	MCL17ABP	3-LED	20
MCL17APG	MCL17APGP	3-LED, female PL-10 plug	20
MCL17CAB	MCL17CABP	3-LED, clear lens	20
MCL19AB	MCL19ABP	4-LED	20
MCL19CAB	MCL19CABP	4-LED, clear lens	20
RED			
MCL17RB	MCL17RBP	3-LED	20
MCL17RPG	MCL17RPGP	3-LED, female PL-10 plug	20
MCL17CRB	MCL17CRBP	3-LED, clear lens	20
MCL19RB	MCL19RBP	4-LED	20
MCL19CRB	MCL19CRBP	4-LED, clear lens	20
ACCESSORIES			
A17GB	A17GBP	Black gasket for 3-LED models	100

FMVSS	P2
MATERIALS	Polycarbonate lens and housing
VOLT/AMP	MCL17: 12.8VDC - 0.047A MCL19: 12.8VDC - 0.051A
WT/DIMS	MCL17: .088 lbs. / 4.188" x 1.375" x .75" MCL19: .132 lbs. / 5.75" x 1.563" x .75"
WARRANTY	Lifetime LED Warranty

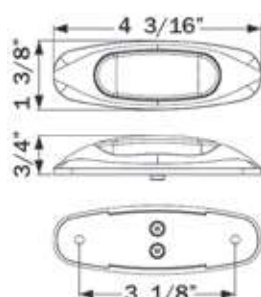

MCL17

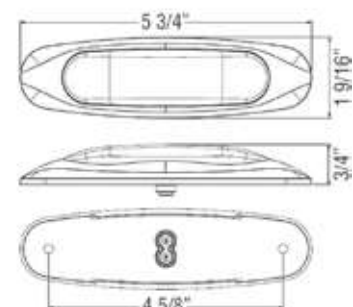

MCL19

MCL31 SERIES

Surface Mount LED Marker/Clearance Lights with Reflex

- Snap-on, replaceable lens
- Lens with reflex eliminates need for separate reflector
- Two-wire design includes both lead and ground wire for mounting to all surfaces

BULK P/N	POLYPACK P/N	DESCRIPTION	QTY
YELLOW - 6 DIODES			
MCL31AB	MCL31ABP	Light only, white base	20
RED - 6 DIODES			
MCL31RB	MCL31RBP	Light only, white base	20
FMVSS	A P2		
MATERIALS	Acrylic lens, ABS housing		
VOLT/AMP	12.8VDC - 0.040A		
WT/DIMS	.132 lbs. / 4" x 2.063" x 1"		
WARRANTY	Lifetime LED Warranty		



MCL31AB



MCL31RB

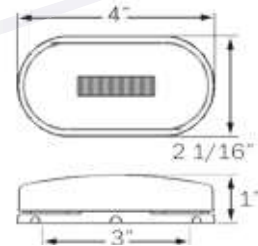

MCL32 SERIES

Surface Mount LED Marker/Clearance Lights with Reflex

- Snap-on, replaceable lens
- Lens with reflex eliminates need for separate reflector
- Two-wire design includes both lead and ground wire for mounting to all surfaces

BULK P/N	POLYPACK P/N	DESCRIPTION	QTY
YELLOW - 3 DIODES			
MCL32AB	MCL32ABP	Light only, white base	100
MCL32ABB	MCL32ABBP	Light only, black base	100
RED - 3 DIODES			
MCL32RB	MCL32RBP	Light only, white base	100
MCL32RBB	MCL32RBBP	Light only, black base	100
RETAIL			
MCL32AS		Yellow light with white base	12
MCL32ABS		Yellow light with black base	12
MCL32RS		Red light with white base	12
MCL32RBS		Red light with black base	12

FMVSS	A P2		
MATERIALS	Acrylic lens, ABS housing		
VOLT/AMP	12.8VDC - 0.2A		
WT/DIMS	.132 lbs. / 4" x 2" x 1"		
WARRANTY	Lifetime LED Warranty		



MCL32AB



MCL32RB





MCL35A32G Surface Mount LED Marker/ Clearance Light with Reflex

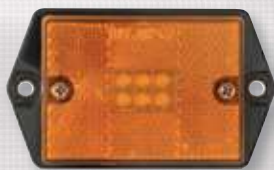

MCL35A32G

- Surface mount black base, mounts on 3-5/16" centers
- Lens with reflex eliminates need for separate reflector
- Self grounding; 32" power wire with .180 male bullet

BULK P/N	POLYPACK P/N	DESCRIPTION	QTY
YELLOW - 6 DIODES			
MCL35A32G	MCL35A32GP	Light, 32" lead with .180 male bullet	50

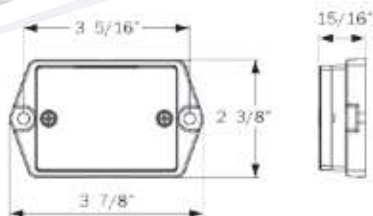

FMVSS	A P2
MATERIALS	Acrylic lens, ABS housing
VOLT/AMP	12.8VDC - 0.165A
WT/DIMS	.110 lbs. / 3.875" x 2.375" x 0.938"
WARRANTY	Lifetime LED Warranty



MCL36 SERIES Stud Mount LED Marker/ Clearance Light with Reflex



MCL36AB



MCL36RB

- Stud mount black base; two-wire design
- Lens with reflex eliminates need for separate reflector

BULK P/N	POLYPACK P/N	DESCRIPTION	QTY
YELLOW - 6 DIODES			
MCL36AB	MCL36ABP	Hard wired	20
MCL36APG	MCL36APGP	Hard wired, .180 male bullets	20
RED - 6 DIODES			
MCL36RB	MCL36RBP	Hard wired	20
RETAIL			
MCL36AS		Yellow light with hardware, clam	12

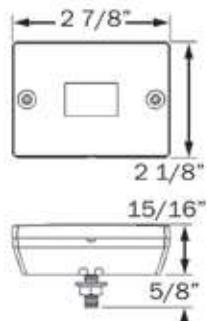

FMVSS	A P2
MATERIALS	Acrylic lens, ABS housing
VOLT/AMP	12.8VDC - 0.054A
WT/DIMS	.110 lbs. / 2.875" x 2.125" x .938"
WARRANTY	Lifetime LED Warranty

MCL40/44 SERIES

Surface Mount LED Marker/ Clearance Lights with Reflex

- Select from 2-LED and 6-LED models in amber and red
- Snap-on, replaceable lens
- Surface mount white base, mounts on 3" centers
- Lens with reflex eliminates need for separate reflector
- Single wire and two-wire designs available



SURFACE MOUNT LED
MARKER/CLEARANCE LIGHTS



MCL40/44AB



MCL40/44RB

BULK P/N	POLYPACK P/N	DESCRIPTION	QTY
YELLOW			
MCL40AB	MCL40ABP	2-LED, 2-wire, power and ground	20
MCL40AB1	MCL40AB1P	2-LED, 1-wire, self grounding	20
MCL40APB	MCL40APBP	2-LED, 2-wire .180 male bullets	20
MCL44AB	MCL44ABP	6-LED, 2-wire, power and ground	20
MCL44AB1	MCL44AB1P	6-LED, 1-wire, self grounding	20
RED			
MCL40RB	MCL40RBP	2-LED, 2-wire, power and ground	20
MCL40RB1	MCL40RB1P	2-LED, 1-wire, self grounding	20
MCL44RB	MCL44RBP	6-LED, 2-wire, power and ground	20
MCL44RB1	MCL44RB1P	6-LED, 1-wire, self grounding	20
ACCESSORIES			
A44GTB	-	Mounting gasket, white	1000
RETAIL			
MCL40AS		2-LED, 2-wire, yellow, clam	12
MCL40RS		2-LED, 2-wire, red, clam	12

FMVSS	P2 A
MATERIALS	Acrylic lens, ABS housing
VOLT/AMP	12.8VDC - 2-LED 0.040A; 6-LED .054A
WT/DIMS	.088 lbs. / 4" x 1.5" x 0.938"
WARRANTY	Lifetime LED Warranty

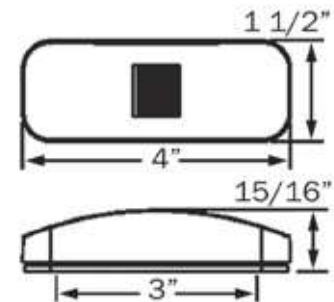



MCL45/46AB



MCL45/46RB

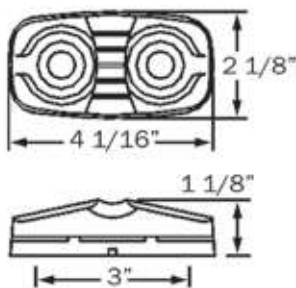

MCL45/46 SERIES LED Double Bullseye Style Marker/Clearance Lights



- Snap-on, replaceable lens
- Surface mount white base, mounts on 3" centers
- Single wire and two-wire designs available

BULK P/N	POLYPACK P/N	DESCRIPTION	QTY
YELLOW - 10 DIODES			
MCL45AB	MCL45ABP	1-wire, self grounding	20
MCL46AB	MCL46ABP	2-wire, power and ground	20
RED - 10 DIODES			
MCL45RB	MCL45RBP	1-wire, self grounding	20
MCL46RB	MCL46RBP	2-wire, power and ground	20
ACCESSORIES			
AL46AB	AL46ABP	Yellow replacement lens	50
AL46RB	AL46RBP	Red replacement lens	50

FMVSS	P2 PC
MATERIALS	Acrylic lens, ABS housing
VOLT/AMP	12.8VDC - 0.087A
WT/DIMS	.088 lbs. / 4.063" x 2.125" x 1.125"
WARRANTY	Lifetime LED Warranty



MCL49AB

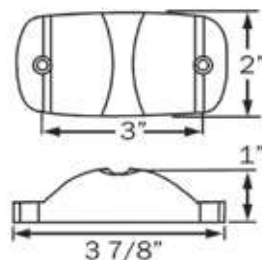

MCL49AB Surface Mount Sealed LED Marker/Clearance Light



- Sonically sealed, waterproof
- Surface mount, mounts on 3" centers
- Includes both lead and ground wire

BULK P/N	POLYPACK P/N	DESCRIPTION	QTY
YELLOW - 14 DIODES			
MCL49AB	MCL49ABP	Light only	20
FMVSS	P2 PC		
MATERIALS	Polycarbonate lens and housing		
VOLT/AMP	12.8VDC - 0.87A		
WT/DIMS	.132 lbs. / 3.875" x 2" x 1"		
WARRANTY	Lifetime LED Warranty		

MCL48 SERIES

LED Intermediate Side Marker Light with Supplemental Mid-Ship Turn

- Sonically sealed, waterproof
- Surface mount, mounts on 4-13/16" centers
- Includes both lead and ground wires

BULK P/N	POLYPACK P/N	DESCRIPTION	QTY
YELLOW - 16 DIODES			
MCL48AB	MCL48ABP	Light	20
MCL48CAB	MCL48CABP	Light, clear lens	20
MCL48AKB	MCL48AKBP	Kit: MCL48AB with A48CB bezel	20
ACCESSORIES			
A48CB	A48CBP	Chrome bezel	50

FMVSS	P2
MATERIALS	Polycarbonate lens and housing
VOLT/AMP	12.8VDC - Side marker .074A; Turn signal .248A
WT/DIMS	.221 lbs. / 6" x 2.25" x 1.375"
WARRANTY	Lifetime LED Warranty



MCL48AB



MCL48CAB

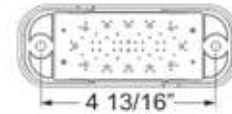
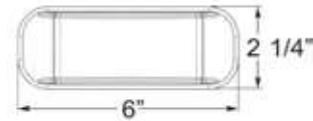

MCL73 SERIES

LED Surface Mount Marker/Clearance Lights



- Sonically sealed, waterproof
- Surface mount, mounts on 4-13/16" centers
- Includes both lead and ground wires

BULK P/N	POLYPACK P/N	DESCRIPTION	QTY
YELLOW - 16 DIODES			
MCL73AB	MCL73ABP	Light	20
RED - 16 DIODES			
MCL73RB	MCL73RBP	Light	20
ACCESSORIES			
A48CB	A48CBP	Chrome bezel	50

FMVSS	P2 PC
MATERIALS	Polycarbonate lens and housing
VOLT/AMP	12.8VDC - .248A
WT/DIMS	.221 lbs. / 6" x 2.25" x 1.375"
WARRANTY	Lifetime LED Warranty



MCL73AB



MCL73RB



MCL66AB



MCL66CAB



MCL66CRB



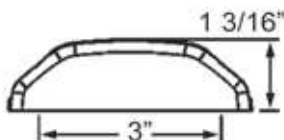

MCL66RB



MCL66 SERIES

Sealed LED Surface Mount Marker/Clearance Lights

- Select from 6-LED and 2-LED models in amber and red
- Sonically sealed, waterproof
- Surface mount, mounts on 3" centers
- Includes both lead and ground wire
- MCL166 series lights include a gasket and wire outlet grommet

BULK P/N	POLYPACK P/N	DESCRIPTION	QTY
YELLOW			
MCL66AB	MCL66ABP	6-LED, 12V	20
MCL66APG	MCL66APGP	6-LED, 12V, .180 male bullets	20
MCL66A24B	MCL66A24BP	6-LED, 12-24V	20
MCL66CAB	MCL66CABP	6-LED, 12V, clear lens	20
MCL166AB	MCL166ABP	2-LED, 12V with gasket	20
RED			
MCL66RB	MCL66RBP	6-LED, 12V	20
MCL66RPG	MCL66RPGP	6-LED, 12V, .180 male bullets	20
MCL66R24B	MCL66R24BP	6-LED, 12-24V	20
MCL66CRB	MCL66CRBP	6-LED, 12V, clear lens	20
MCL166RB	MCL166RBP	2-LED, 12V with gasket	20
ACCESSORIES			
A66GB	A66GBP	Gasket, black	100
BK66DB	BK66DBP	Heavy duty armored base, die cast metal	50
RETAIL			
MCL66AS		Yellow 6-LED, 12V, clam	12
MCL66RS		Red 6-LED, 12V, clam	12

FMVSS	P2
MATERIALS	Polycarbonate lens and housing
VOLT/AMP	12.8VDC - 0.057A
WT/DIMS	.088 lbs. / 4" x .875" x 1.188"
WARRANTY	Lifetime LED Warranty

MCL71 SERIES

Low Profile LED Marker/ Clearance Light

- Chrome plated housing, replaceable lens
- Includes both lead and ground wire

BULK P/N	POLYPACK P/N	DESCRIPTION	QTY
RED - 2 DIODES			
MCL71RB	MCL71RBP	Flush mount marker light	20
FMVSS	P2		
MATERIALS	Acrylic lens, chrome plated ABS bezel		
VOLT/AMP	12.8VDC - 0.054A		
WT/DIMS	.088 lbs. / 3.75" x 2.25" x 1/2"		
WARRANTY	Lifetime LED Warranty		



MCL71RB

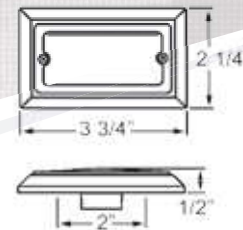

MCL76 SERIES

Sealed LED Surface Mount Marker/ Clearance Lights with Reflex

- Sonically sealed, waterproof
- Surface mount, mounts on 4-13/16" centers
- Lens with reflex eliminates need for a separate reflector
- Includes weathertight pigtail with both lead and ground wire

BULK P/N	POLYPACK P/N	DESCRIPTION	QTY
YELLOW - 4 DIODES			
MCL76AB	MCL76ABP	Light with reflex	20
RED - 4 DIODES			
MCL76RB	MCL76RBP	Light with reflex	20

FMVSS	A P2
MATERIALS	Polycarbonate lens and housing
VOLT/AMP	12.8VDC - 0.063A
WT/DIMS	.132 lbs. / 5.813" x 2" x 1.188"
WARRANTY	Lifetime LED Warranty

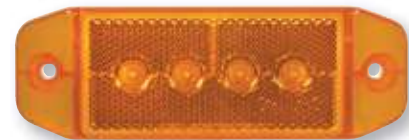

MCL76AB



MCL76RB

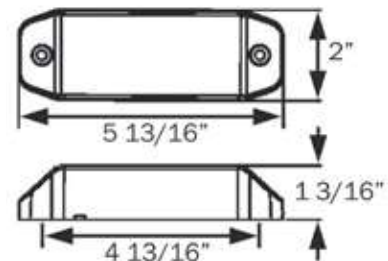



MCL85AB

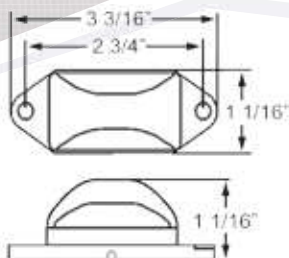

MCL85 SERIES

Sealed LED Surface Mount Amber Marker/Clearance Light

- Sonically sealed, waterproof
- Surface mount, mounts on 2-3/4" centers
- Single wire design grounds through mounting hardware

BULK P/N	POLYPACK P/N	DESCRIPTION	QTY
YELLOW - 3 DIODES			
MCL85AB	MCL85ABP	Surface mount light	50

FMVSS	P2 P3
MATERIALS	Polycarbonate lens and housing
VOLT/AMP	12.8VDC - 0.066A
WT/DIMS	.044 lbs. / 3.188" x 1.063" x 1.188"
WARRANTY	Lifetime LED Warranty



MCL81AB



MCL81RB

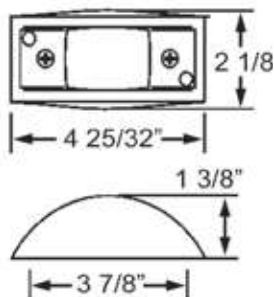

MCL81 SERIES

Chrome Plated LED Marker/Clearance Lights



- Chrome plated ABS housing
- Includes both lead and ground wire

BULK P/N	POLYPACK P/N	DESCRIPTION	QTY
YELLOW - 6 DIODES			
MCL81AB	MCL81ABP	Light with ABS housing	20
RED - 6 DIODES			
MCL81RB	MCL81RBP	Light with ABS housing	20

FMVSS	P2 PC
MATERIALS	Acrylic lens, chrome plated ABS bezel
VOLT/AMP	12.8VDC - 0.153A
WT/DIMS	.265 lbs. / 4.781" x 2.125" x 1.375"
WARRANTY	Lifetime LED Warranty

MCL86 SERIES

Armored Die Cast LED Marker/Clearance Lights



- Die cast steel housing, mounting gasket
- Surface mount, mounts on 3-7/8" centers
- Two-wire design with power and ground wires



BULK P/N	POLYPACK P/N	DESCRIPTION	QTY
YELLOW - 6 DIODES			
MCL86AB	MCL86ABP	Light with steel housing	20
RED - 6 DIODES			
MCL86RB	MCL86RBP	Light with steel housing	20

FMVSS	P2 PC
MATERIALS	Acrylic lens, steel housing
VOLT/AMP	12.8VDC - 0.20A
WT/DIMS	.463 lbs. / 4.5" x 2.25" x 1.5"
WARRANTY	Lifetime LED Warranty

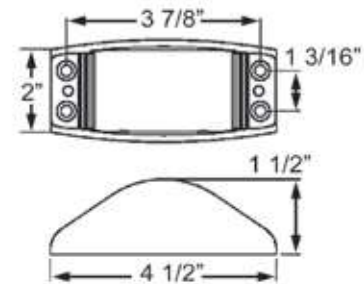

MCL95 SERIES

Sealed Stud Mount LED Marker/Clearance Lights



- Sonically sealed, waterproof
- Single wire design grounds through mounting hardware

BULK P/N	POLYPACK P/N	DESCRIPTION	QTY
YELLOW - 3 DIODES			
MCL95AB	MCL95ABP	1-wire, 20" lead	50
MCL95ABF	MCL95ABFP	2-wire, 5mm female barrels	50
RED - 3 DIODES			
MCL95RB	MCL95RBP	1-wire, 20" lead	50
MCL95RBF	MCL95RBFP	2-wire, 5mm female barrels	50



RETAIL			
MCL95AS		Yellow, clam	12
MCL95RS		Red, clam	12

FMVSS	P2 P3
MATERIALS	Polycarbonate lens and housing, stainless steel base, plated steel stud
VOLT/AMP	12.8VDC - 0.051A
WT/DIMS	.088 lbs. / 2.125" x 1.125" x 1.063"
WARRANTY	Lifetime LED Warranty

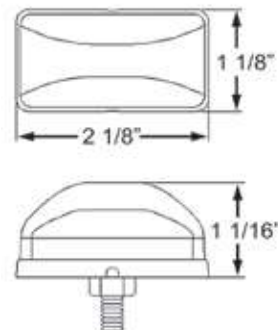



CBL22AB

CBL22RB

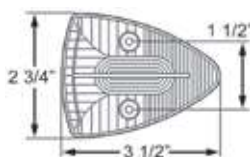

CBL22 SERIES Sealed LED Triangular Cab/Clearance Light



- Sonically sealed, waterproof
- Design includes lead and ground wire
- Mounting gasket included

BULK P/N	POLYPACK P/N	DESCRIPTION	QTY
YELLOW - 15 DIODES			
CBL22AB	CBL22ABP	Cab light	50
CBL22CAB	CBL22CABP	Cab light, clear lens	50
RED - 15 DIODES			
CBL22RB	CBL22RBP	Cab light	50
RETAIL			
CBL22AS		Yellow cab light, clam	12

FMVSS	P2 PC
MATERIALS	Polycarbonate lens and housing
VOLT/AMP	12.8VDC - 0.107A
WT/DIMS	.176 lbs. / 3.5" x 2.75" x 1.688"
WARRANTY	Lifetime LED Warranty

MCL70 SERIES

Sealed LED Identification Light Bars for Over 80" Applications

- Sonically sealed, waterproof
- Ultra thin – only 5/8" thick
- Design includes both lead and ground wire



MCL70RB

MCL70RCB

BULK P/N	POLYPACK P/N	DESCRIPTION	QTY
RED ID LIGHT BAR - 3 DIODES			
MCL70RB	MCL70RBP	ID light bar	10
MCL70RBF2	MCL70RBF2P	ID light bar, .180 female barrels	10
MCL70RCB	MCL70RCBP	ID light bar, clear lens	10
ACCESSORIES			
A69CB	A69CBP	Chrome base/bezel	10
A69GB	A69GBP	Mounting gasket, black	10
RETAIL			
MCL70RS		Red, clam	20

FMVSS	P2
MATERIALS	Polycarbonate lens and housing
VOLT/AMP	12.8VDC - 0.038A
WT/DIMS	.441 lb. / 15" x 1.375" x .625"
WARRANTY	Lifetime LED Warranty

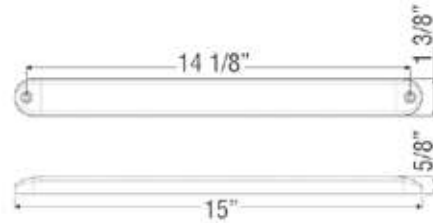

MCL78/88 SERIES

Sealed LED Identification Light Bars for Over 80" Applications

- Sonically sealed, waterproof
- Ultra thin – only 1" thick
- Design includes both lead and ground wire



MCL78RB

MCL88RCB

BULK P/N	POLYPACK P/N	DESCRIPTION	QTY
RED ID LIGHT BAR - 3 DIODES			
MCL78RB	MCL78RBP	ID light bar	10
MCL88RCB	MCL88RCBP	ID light bar, clear lens	10
ACCESSORIES			
A79CB	A79CBP	Chrome base/bezel	10

FMVSS	P2
MATERIALS	Polycarbonate lens and housing
VOLT/AMP	12.8VDC - 0.022A
WT/DIMS	.441 lb. / 17" x 1.375" x 1"
WARRANTY	Lifetime LED Warranty

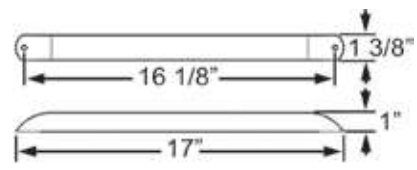



MCL83 SERIES

FLEET Count™ Sealed LED Identification Light Bar for Over 80" Applications

MCL83RB



MCL83RCB

- Sonically sealed, waterproof lights snap onto corrosion proof polycarbonate base
- Design includes both lead and ground wire

BULK P/N	POLYPACK P/N	DESCRIPTION	QTY
RED ID LIGHT BAR - 3 DIODES			
MCL83RB	MCL83RBP	3-LED ID light bar	10
MCL83RCB	MCL83RCBP	Clear lens, red diodes	10
AL90RB	AL90RBP	1-LED replacement light	50
RETAIL			
MCL83RK		3-LED ID light bar, slipover blister	6

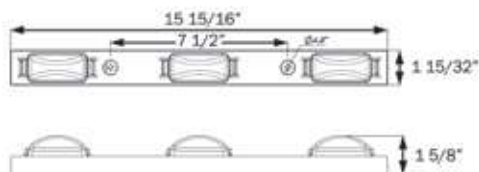

FMVSS	P2
MATERIALS	Polycarbonate lens and housing
VOLT/AMP	12.8VDC - .069A
WT/DIMS	.397 lb. / 15.938" x 1.469" x 1.625"
WARRANTY	Lifetime LED Warranty



MCL93 SERIES

Sealed LED Identification Light Bar for Over 80" Applications



MCL93RB

- Sonically sealed, waterproof lights snap onto corrosion proof polycarbonate base
- Design includes both lead and ground wire

BULK P/N	POLYPACK P/N	DESCRIPTION	QTY
RED ID LIGHT BAR - 9 DIODES			
MCL93RB	MCL93RBP	9-LED ID light bar	10
MCL93RPG	MCL93RPGP	9-LED ID light bar, .180 male bullet on power, eyelet on ground	10
AL91RB	AL91RBP	3-LED replacement light	50
RETAIL			
MCL93RK		9-LED ID light bar, slipover blister	6

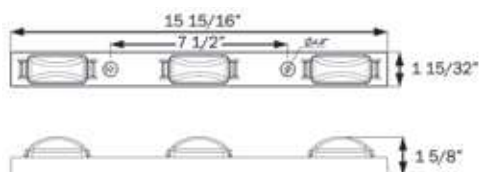

FMVSS	P2
MATERIALS	Polycarbonate lens and housing
VOLT/AMP	12.8VDC - 0.153A
WT/DIMS	.397 lb. / 15.938" x 1.469" x 1.625"
WARRANTY	Lifetime LED Warranty

MCL84 SERIES

Sealed LED Identification Light Bar for Over 80" Applications



- Sonically sealed, waterproof lights snap onto stainless steel base
- Design includes both lead and ground wire



MCL84RB

BULK P/N	POLYPACK P/N	DESCRIPTION	QTY
RED ID LIGHT BAR - 9 DIODES			
MCL84RB	MCL84RBP	9-LED ID light bar	10
AL91RB	AL91RBP	3-LED replacement light	50

FMVSS	P2
MATERIALS	Polycarbonate light, stainless steel housing
VOLT/AMP	12.8VDC - .153A
WT/DIMS	.397 lb. / 16.5" x 1.375" x 1.625"
WARRANTY	Lifetime LED Warranty

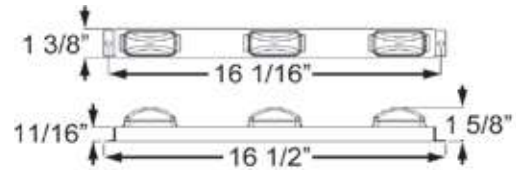

MCL97 SERIES

Sealed LED Identification Light Bar for Over 80" Applications



- Sealed, waterproof lights on stainless steel base
- Single wire, grounds through mounting hardware



MCL97RB

BULK P/N	POLYPACK P/N	DESCRIPTION	QTY
RED ID LIGHT BAR - 9 DIODES			
MCL97RB	MCL97RBP	9-LED ID light bar	10
MCL97RPG	MCL97RPGP	9-LED ID light bar, .180 male bullet	10

RETAIL			
MCL97RK		ID light bar, slipover blister	6

FMVSS	P2 P3
MATERIALS	Polycarbonate light, stainless steel base
VOLT/AMP	12.8VDC - .153A
WT/DIMS	.287 lb. / 14.25" x 1.188" x 1.313"
WARRANTY	Lifetime LED Warranty

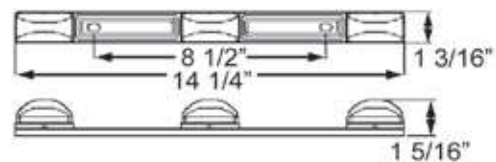



MCL98 SERIES

Sealed LED Identification Light Bar for Over 80" Applications



MCL98RB

- Sonically sealed, waterproof
- Compact – 14.25" x 1.125"
- Design includes both lead and ground wire

BULK P/N	POLYPACK P/N	DESCRIPTION	QTY
RED ID LIGHT BAR - 3 DIODES			
MCL98RB	MCL98RBP	ID light bar	10
RETAIL			
MCL98RK		Light bar, slipover blister	6

FMVSS	P2
MATERIALS	Polycarbonate lens and housing
VOLT/AMP	12.8VDC - 0.020A
WT/DIMS	.243 lb. / 14.25" x 1.125" x .875"
WARRANTY	Lifetime LED Warranty

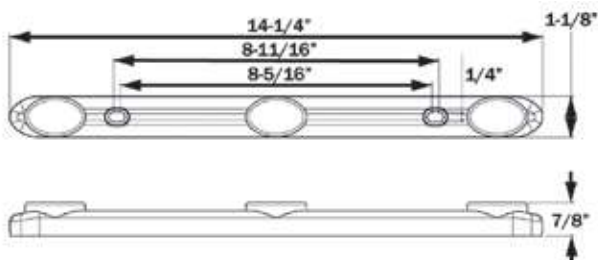

MCL1922 SERIES

GloLight® Sealed 3/4" LED Identification Lights for Over 80" Applications

GloLight®

PATENTED TECHNOLOGY

- Sonically sealed, waterproof
- Design includes both lead and ground wire



MCL1922RB

BULK P/N	POLYPACK P/N	DESCRIPTION	QTY
RED ID LIGHTS - 3 DIODES			
MCL1922RB	MCL1922RBP	ID light bar, molded black base	10
MCL112RB	MCL112RBP	GloLight® replacement light	50

FMVSS	P2
MATERIALS	Polycarbonate lens and housing
VOLT/AMP	12.8VDC - 0.022A
WT/DIMS	MCL922RB: .441 lb. / 14.875" x 1.25" x 1"
WARRANTY	Lifetime LED Warranty



MCL1922RB

LED IDENTIFICATION LIGHT BARS

MCL922 & MCL12/22 SERIES

Sealed 3/4" LED Identification Lights for Over 80" Applications

optronics LED

- Sonically sealed, waterproof
- Design includes both lead and ground wire



MCL922RB

BULK P/N	POLYPACK P/N	DESCRIPTION	QTY
RED ID LIGHTS - 3 DIODES			
MCL922RB	MCL922RBP	ID light bar, molded black base	10
MCL12RK3B	MCL12RK3BP	(3) red MCL12 lights, molded harness	20
MCL12RK3RMB	-	(3) red MCL12 lights, molded harness, weathertight plug	50
MCL22RK3B	-	(3) red MCL12 lights, molded harness, supplemental turn function	50
MCL22RK4B	-	(3) red MCL12 lights, supplemental turn function, amp connector	20
MCL12RB	MCL12RBP	Single diode replacement light	50



MCL12RK3B

FMVSS	P2
MATERIALS	Polycarbonate lens and housing
VOLT/AMP	12.8VDC - 0.022A
WT/DIMS	MCL922RB: .441 lb. / 14.875" x 1.25" x 1"
WARRANTY	Lifetime LED Warranty

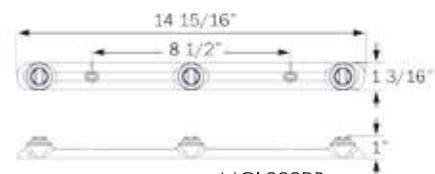

MCL922RB



LPL11 SERIES Snap-In LED Mini License Plate Light

- Chrome-plated brass construction
- Easy snap-in mounting
- Sonically sealed, waterproof
- Two-wire design includes both lead and ground wire



BULK P/N	POLYPACK P/N	DESCRIPTION	QTY
LICENSE LIGHT - 2 DIODES			
LPL11CB	LPL11CBP	Snap-in, license light	50

FMVSS	(2) L
MATERIALS	Polycarbonate lens and brass housing
VOLT/AMP	12.8VDC - 0.14A
WT/DIMS	.068lbs. / 1.5" x 1.5" x 1.125"
WARRANTY	Lifetime LED Warranty

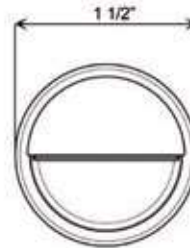

HOLE CUT-OUT: 1.25"

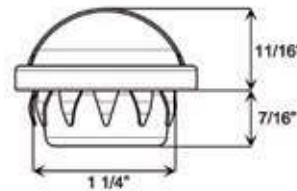

LPL12 SERIES 3/4" Sealed LED License Light

- Sealed, waterproof
- Meets SAE J587 when properly mounted using brackets listed below
- Design includes both lead and ground wire



LPL12CB

BULK P/N	POLYPACK P/N	DESCRIPTION	QTY
LICENSE LIGHT - 2 DIODES			
LPL12CB	LPL12CBP	Light with .180 female barrels	20
LPL12CPGB	LPL12CPGBP	Light with .180 male bullets	20
LPL12CKM2B	LPL12CKM2BP	Kit: LPL12CPGB, A12B2LPB surface mount bracket, A12GLPB grommet	50
LPL12CKMB	LPL12CKMBP	Kit: LPL12CPGB with A11BLPB bracket	20
LPL12CKF2B	LPL12CKF2BP	Kit: LPL12CB, A12B2LPB surface mount bracket, A12GLPB grommet	50
LPL12CKM5B	LPL12CKM5BP	Kit: LPL12CPGB, A12B2LPB surface mount bracket with gasket, A12GLPB grommet	50
ACCESSORIES			
A11BLPB	A11BLPBP	Black flush mount bracket	50
A11GLPB	A11GLPBP	Gray flush mount bracket	50
A12B2LPB	A12B2LPBP	Black vertical mount bracket	50
A12GLPB	A12GLPBP	Grommet for A12B2LPB	50



Kit with A12B2LPB bracket



LPL12CKMB

FMVSS	L
MATERIALS	Polycarbonate lens and housing
VOLT/AMP	12.8VDC - 0.11A
WT/DIMS	.022 lb. / 0.74" x 0.74" x .938"
WARRANTY	Lifetime LED Warranty

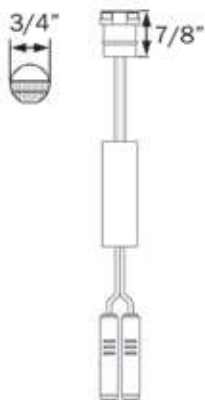

LPL12CB

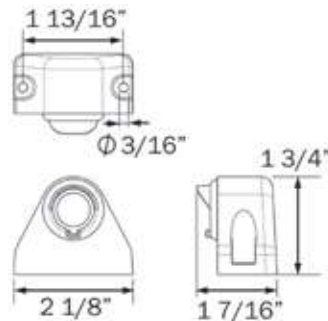

A12B2LPB

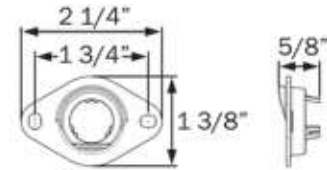

A11GLPB



LPL21CB

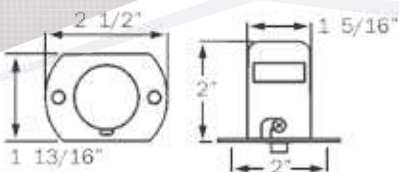

LPL21 SERIES LED Heavy Duty License Plate Light

- Armored light made of durable, chrome plated steel
- Surface mount on 2" centers
- Design includes both lead and ground wire

BULK P/N	POLYPACK P/N	DESCRIPTION	QTY
LICENSE LIGHT - 1 DIODE			
LPL21CB	LPL21CBP	Armored license light	20

FMVSS	L
MATERIALS	Steel, polycarbonate lens
VOLT/AMP	12.8VDC - 0.054A
WT/DIMS	.132 lb. / 2.5" x 1.813" x 2"
WARRANTY	Lifetime LED Warranty



LPL31CB



LPL31CSB

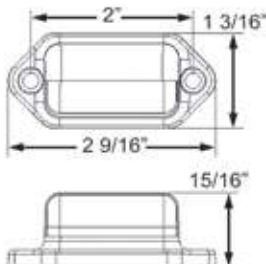

LPL31CB

LPL31 SERIES Mini LED License Light

- Polished, chrome plated housing
- Surface mount on 2" centers
- Design includes both lead and ground wire
- Two LPL31CB/CEZB required to meet DOT requirements, mounted on each side
- Single LPL31CSB required to meet DOT requirements, mounted at center

BULK P/N	POLYPACK P/N	DESCRIPTION	QTY
LICENSE LIGHT - 2 DIODES			
LPL31CB	LPL31CBP	License light	20
LPL31CEZB	LPL31CEZBP	License light, .180 female barrels	20
LPL31CPG	LP31CPGP	License light, .156 female barrels	20
LPL31CSB	LPL31CSBP	Light with spacer	50

RETAIL

LPL31CS		Light with mounting hardware, clam	12
---------	---	------------------------------------	----

FMVSS	(2) L
MATERIALS	Polycarbonate lens, chrome plated stainless steel bezel
VOLT/AMP	12.8VDC - 0.027A
WT/DIMS	.066 lb. / 2.563" x 1.188" x .938"
WARRANTY	Lifetime LED Warranty

LPL41/43 SERIES Surface Mount LED License Light

- Armored housing
- Surface mount using ears or studs
- Design includes both lead and ground wire

BULK P/N	POLYPACK P/N	DESCRIPTION	QTY
LICENSE LIGHT			
LPL41CB	LPL41CBP	5-LED ear mount license light, chrome finish housing	20
LPL42CBF	LPL42CBFP	5-LED stud mount license light, chrome finish housing	20
LPL43CB	LPL43CBP	3-LED ear mount license light, stainless steel housing	20

FMVSS	L
MATERIALS	Polycarbonate lens, chrome plated housing, stainless steel mounting ears (LPL43 has stainless steel housing)
VOLT/AMP	12.8VDC - 0.054A
WT/DIMS	.176 lb. / 4" x 1.75" x 2.188"
WARRANTY	Lifetime LED Warranty



LPL41CB



LPL42CBF

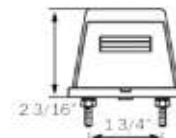

LPL55 SERIES LED License Light with Bracket

- Light attached to corrosion proof black bracket
- Surface mount on 3-1/4" centers
- Design includes both lead and ground wire



LPL55CB



BULK P/N	POLYPACK P/N	DESCRIPTION	QTY
LICENSE LIGHT - 5 DIODES			
LPL55CB	LPL55CBP	Light with ABS bracket	10
LPL55CPG	LPL55CPGP	Light with ABS bracket, female PL-10 plug	10
LPL55CKB	LPL55CKBP	Light/bracket, gasket and hardware	10
LPL56CB	LPL56CBP	Light with steel bracket and gasket	10

FMVSS	L
MATERIALS	Polycarbonate lens and housing, plastic bracket
VOLT/AMP	12.8VDC - 0.045A
WT/DIMS	.198 lb. / 8.625" x 3.25" x 2.375"
WARRANTY	Lifetime LED Warranty

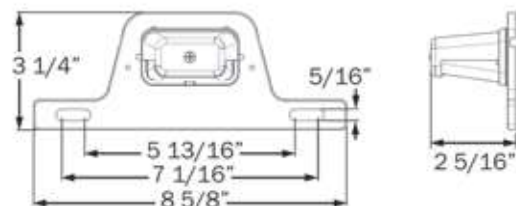



LPL61C24B

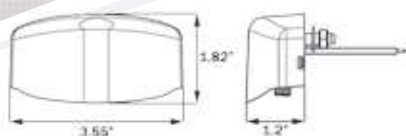

LPL61 SERIES LED License Light

- Sonically sealed, waterproof
- Design includes both lead and ground wire

BULK P/N	POLYPACK P/N	DESCRIPTION	QTY
LICENSE LIGHT - 6 DIODES			
LPL61C24B	LPL61C24BP	LED license light, black housing, 12-24V	50

FMVSS	L
MATERIALS	Polycarbonate
VOLT/AMP	12.8VDC - 0.02A
WT/DIMS	.132 lb. / 3.55" x 1.2" x 1.82"
WARRANTY	Lifetime LED Warranty



LPL65CB

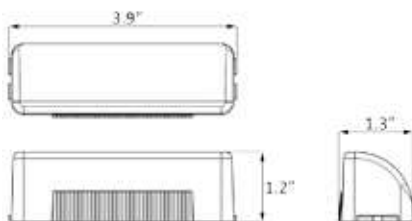

LPL65 SERIES LED License Light

- Sonically sealed, waterproof
- Accept standard 1- or 2-wire plugs
- Single wire design grounds through mounting hardware
- Two-wire design includes both lead and ground wire for mounting to all surfaces

BULK P/N	POLYPACK P/N	DESCRIPTION	QTY
LICENSE LIGHT - 3 DIODES			
LPL65CB	LPL65CBP	LED license light, gray housing	20

FMVSS	L
MATERIALS	Polycarbonate lens and housing
VOLT/AMP	12.8VDC - 0.052A
WT/DIMS	.089 lb. / 3.9" x 1.3" x 1.2"
WARRANTY	Lifetime LED Warranty

LPL91 SERIES Sealed LED License Light

- Sonically sealed, waterproof
- Use with LP25SB bracket and designated license plate brackets
- Design includes both lead and ground wire

BULK P/N	POLYPACK P/N	DESCRIPTION	QTY
LICENSE LIGHT - 2 DIODES			
LPL91CB	LPL91CBP	License light	50
LPL91CAB	LPL91CABP	License light, .156 female plugs	50
LPL91CPG	LPL91CPGP	License light, female PL-10 connector	50
LPL91CKB	LPL91CKBP	License light, A91OB chrome base	50
LPL91CBKB	LPL91CBKBP	License light, A91BOB black base	50
LPL91CKALPB	LPL91CKALPBP	License light, .150 female barrels, black light bracket, gasket	50
LPL26SKB	LPL26SKBP	License light, .180 male bullets, gray light bracket	50
LICENSE PLATE BRACKETS			
LP25SB	LP25SBP	Bracket, black coated	100
LP25SGGB	LP25SGGBP	Bracket, gray coated	
LP5SB	LP5SBP	Straight license plate bracket	100
LP15SB	LP15SBP	Zinc license plate bracket	12
LP35BB	LP35BBP	License plate holder	25
ACCESSORIES			
A91BB	A91BBP	Black base, self grounding	100
A91BOB	A91BOBP	Black base, open back	100
A91CB	A91CBP	Chrome base, self grounding	100
A91OB	A91OBP	Chrome base, open back	100
A91GB	A91GBP	Grommet	100

FMVSS	L
MATERIALS	Polycarbonate lens and housing
VOLT/AMP	12.8VDC - 0.027A
WT/DIMS	.066 lb. / 2.5" x 1.25" x 0.813"
WARRANTY	Lifetime LED Warranty



LPL91



LPL26SKB

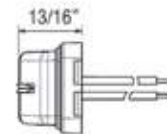
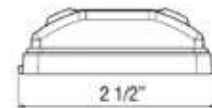

LPL91

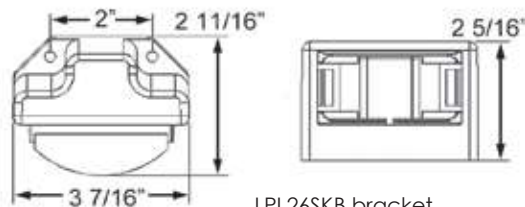

LPL26SKB bracket



BUL13CB

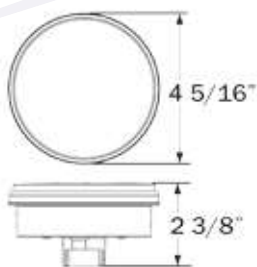

BUL13 SERIES 4" Round Sealed LED Utility Light

- Miro-Flex™ design with Crystal Clear™ lens
- Sonically sealed, waterproof
- Accepts standard two-pin plugs

BULK P/N	POLYPACK P/N	DESCRIPTION	QTY
UTILITY LIGHT - 12 DIODES			
BUL13CB	BUL13CBP	Utility light	10
ACCESSORIES			
A45GB	A45GBP	Grommet	50
A45CB	A45CBP	Pigtail, 2-wire	100
A49PB	A49PBP	Right angle pigtail, 2-wire	100
MATERIALS	Polycarbonate lens and housing		
VOLT/AMP	12.8VDC - 0.074A		
WT/DIMS	.331 lb. / 4.313" x 4.313" x 2.375"		
WARRANTY	Lifetime LED Warranty		



BUL43CB

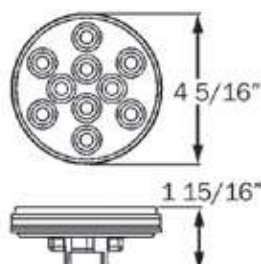

BUL43 SERIES 4" Round Sealed LED Utility Light

- Crystal Clear™ lens
- Sonically sealed, waterproof
- Accepts standard two-pin plugs

BULK P/N	POLYPACK P/N	DESCRIPTION	QTY
UTILITY LIGHT - 10 DIODES			
BUL43CB	BUL43CBP	Utility light	10
BUL43CBK	BUL43CBKP	Kit with A45GB grommet and A45CB pigtail	10
ACCESSORIES			
A45GB	A45GBP	Grommet	50
A45CB	A45CBP	Pigtail, 2-wire	100
A49PB	A49PBP	Right angle pigtail, 2-wire	100
MATERIALS	Polycarbonate lens and housing		
VOLT/AMP	12.8VDC - 0.275A		
WT/DIMS	.529 lb. / 4.313" x 4.313" x 1.938"		
WARRANTY	Lifetime LED Warranty		

BUL69 SERIES Sealed LED Thinline Utility Light



- Sonically sealed, waterproof
- Ultra thin – only 5/8" thick
- Design includes both lead and ground wire



BUL69CB

BULK P/N	POLYPACK P/N	DESCRIPTION	QTY
UTILITY LIGHT - 11 DIODES			
BUL69CB	BUL69CBP	Utility light	10
BUL69CPG	BUL69CPGP	Light with .180 male bullets	10
BUL69CBMCV2B	BUL69CBMCV2BP	Kit: 2-wire female PL-3, A69CB base	10
ACCESSORIES			
A69CB	A69CBP	Chrome base/bezel	10

MATERIALS	Polycarbonate lens and housing
VOLT/AMP	12.8VDC - 0.025A
WT/DIMS	.265 lb. / 15" x 1.375" x .625"
WARRANTY	Lifetime LED Warranty

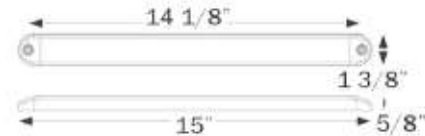

BUL72 SERIES 6" Oval Sealed LED Utility Lights



- Crystal Clear™ lens
- Sonically sealed, waterproof
- Accepts standard two-pin plugs



BUL72CB

BULK P/N	POLYPACK P/N	DESCRIPTION	QTY
UTILITY LIGHT - 10 DIODES			
BUL72CB	BUL72CBP	Utility light	10
BUL72CBGK	BUL72CBGKP	Utility light with A70GB grommet	50
BUL74CBK	BUL74CBKP	Utility light with A70GB & A49PB	50
ACCESSORIES			
A70GB	A70GBP	Grommet	50
A45CB	A45CBP	Pigtail, 2-wire	100
A49PB	A49PBP	Right angle pigtail, 2-wire	100

MATERIALS	Polycarbonate lens and housing
VOLT/AMP	12.8VDC - 0.080A
WT/DIMS	.529 lb. / 6.438" x 2.313" x 1.75"
WARRANTY	Lifetime LED Warranty

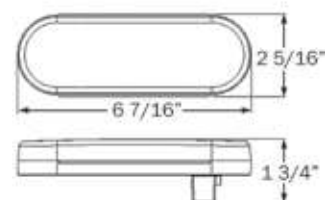



BUL73CB

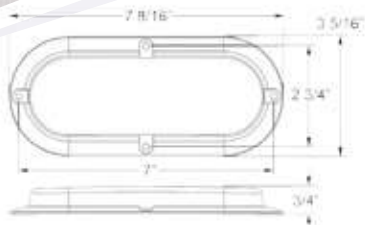

BUL73 SERIES

FLEET Count™ 6" Oval Sealed LED Utility Light for Surface Mount

- Sonically sealed, waterproof
- Surface flange mount – no panel cutout required
- Design includes both lead and ground wire

BULK P/N	POLYPACK P/N	DESCRIPTION	QTY
UTILITY LIGHT - 6 DIODES			
BUL73CB	BUL73CBP	Utility light	10
ACCESSORIES			
A78CB	A78CBP	Chrome trim ring	25
MATERIALS	Polycarbonate lens and housing		
VOLT/AMP	12.8VDC - 0.054A		
WT/DIMS	.265 lb. / 7.563" x 3.313" x .75"		
WARRANTY	Lifetime LED Warranty		



BUL78CB

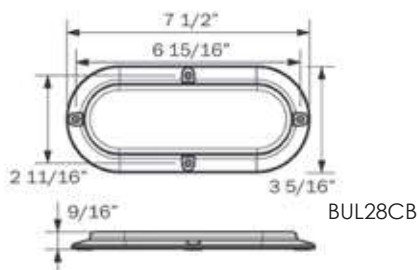
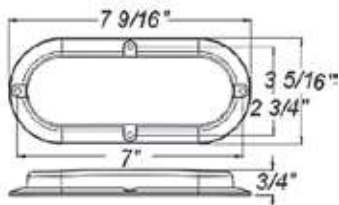

BUL28CB

BUL78 SERIES

6" Oval Sealed LED Utility Light for Surface Mount

- Sonically sealed, waterproof
- Surface flange mount – no panel cutout required
- Design includes both lead and ground wire

BULK P/N	POLYPACK P/N	DESCRIPTION	QTY
UTILITY LIGHT - 10 DIODES			
BUL78CB	BUL78CBP	Utility light	10
BUL78CEZB	BUL78CEZBP	Utility light with 2-way female PL-3	10
BUL78C3MB	BUL78C3MBP	Utility light with 2-way female PL-3 plug, adhesive back	10
BUL28CLPB	BUL28CLPBP	Low profile utility light with 2-way female PL-3 connector and gasket	10
ACCESSORIES			
A78CB	A78CBP	Chrome trim ring	25
MATERIALS	Polycarbonate lens and housing		
VOLT/AMP	12.8VDC - 0.054A		
WT/DIMS	BUL78: .265 lb. / 7.563" x 3.313" x .75" BUL28: .255 lb. / 7.50" x 3.313" x .5625"		
WARRANTY	Lifetime LED Warranty		

UCL178 SERIES

GloLight® 6" Oval Sealed LED Utility Light for Surface Mount

PATENTED TECHNOLOGY

- Sonically sealed, waterproof
- Surface flange mount – no panel cutout required
- Design includes both lead and ground wire

BULK P/N	POLYPACK P/N	DESCRIPTION	QTY
UTILITY LIGHT - 22 DIODES			
UCL178RFP2B	UCL178RFP2BP	Utility light	10
ACCESSORIES			
A7TRSSB	A7TRSSBP	Stainless steel trim ring	100
A78CB1	A78CB1P	Chrome trim ring	25

MATERIALS	Polycarbonate lens and housing
VOLT/AMP	12.8VDC - 0.050A
WT/DIMS	.265 lb. / 7.50" x 3.25" x 1.25"
WARRANTY	Lifetime LED Warranty

GloLight®



UCL178RFP2B

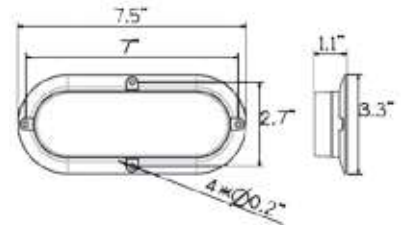

UCL09 SERIES

3" Sealed LED Utility/Hitch Light for Surface Mount

- Designed to illuminate hitch area of trailer
- Sonically sealed, waterproof
- Flange surface mount – no panel cutout required
- Design includes both lead and ground wire

BULK P/N	POLYPACK P/N	DESCRIPTION	QTY
UTILITY LIGHT - 9 DIODES			
UCL09CB	UCL09CBP	Utility light, 9 white LEDs	50
UCL09CBB	UCL09CBBP	Utility light, 6 white, 3 blue LEDs, 3-wire	50
ACCESSORIES			
A09BB	A09BBP	Black snap-on trim ring	50
A09CB	A09CBP	Chrome snap-on trim ring	50
A09WB	A09WBP	White snap-on trim ring	50

MATERIALS	Polycarbonate lens and housing
VOLT/AMP	UCL09CB: 12.8VDC - 0.074A UCL09CBB: 12.8VDC - 0.114A
WT/DIMS	.265 lb. / 3.25" x 3.25" x .813"
WARRANTY	Lifetime LED Warranty

Optronics LED



UCL09CB



UCL09CBB

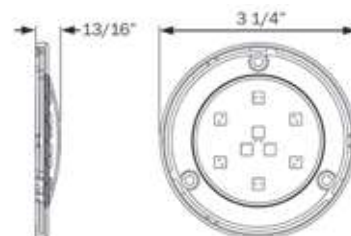



UCL11CKB



UCL11 SERIES 3/4" Sealed LED Utility Light

- Sealed, waterproof
- Compact – fits 3/4" hole
- Design includes both lead and ground wire

BULK P/N	POLYPACK P/N	DESCRIPTION	QTY
UTILITY LIGHT - 2 DIODES			
UCL11CB	UCL11CBP	Utility light	50
UCL11CKB	UCL11CKBP	Kit: UCL11CB & A11GB grommet	50
UCL11CKPG	UCL11CKPGP	Kit: UCL11CB with .180 male bullets & A14GB grommet	50

ACCESSORIES			
A11GB	A11GBP	Grommet	100
A14GB	A14GBP	Sealing grommet, .125-.250" material	100
A11PB	A11PBP	Snap-in mounting flange	100

MATERIALS	Polycarbonate lens and housing
VOLT/AMP	12.8VDC - 0.054A
WT/DIMS	.265 lb. / 0.74" x 0.74" x 0.938"
WARRANTY	Lifetime LED Warranty



UCL13C2PG



UCL13CB2B

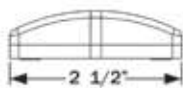
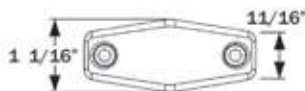

UCL13 SERIES Sealed LED Utility Light

- Sealed, waterproof
- Compact, surface mount design
- Design includes both lead and ground wire

BULK P/N	POLYPACK P/N	DESCRIPTION	QTY
WHITE UTILITY LIGHT - 2 DIODES			
UCL13C2PG	UCL13C2PGP	Utility light, .180 female barrels	20
UCL13CPG	UCL13CPGP	Utility light, .156 male bullets	20
BLUE - 2 DIODES			
UCL13CB2B	UCL13CB2BP	Blue LED utility light	20

ACCESSORIES			
A13C2B	A13C2BP	Chrome base/bezel	100
A13B2B	A13B2BP	Black base/bezel	100
A13G2B	A13G2BP	Gasket	200

MATERIALS	Polycarbonate lens and housing
VOLT/AMP	12.8VDC - 0.020A
WT/DIMS	.088 lb. / 2.5" x 1.063" x .688"
WARRANTY	Lifetime LED Warranty

UCL19 SERIES

Miro-Flex™ Sealed LED Utility Light

- Sealed, waterproof
- Surface mount, mounts on 4-5/8" centers
- Design includes both lead and ground wire

BULK P/N	POLYPACK P/N	DESCRIPTION	QTY
UTILITY LIGHT - 4 DIODES			
UCL19CB	UCL19CBP	Utility light	20

MATERIALS	Polycarbonate lens and housing
VOLT/AMP	12.8VDC - 0.051A
WT/DIMS	.132 lb. / 5.75" x 1.563" x .75"
WARRANTY	Lifetime LED Warranty



UCL19CB

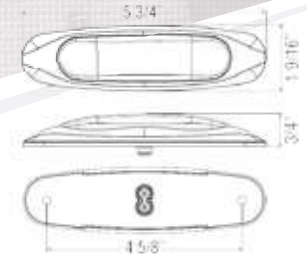

UCL50 SERIES

Miro-Flex™ 2" Sealed LED Utility Light

- Miro-Flex™ design with Crystal Clear™ lens
- Operating voltage 12-24VDC
- Sonically sealed, waterproof
- Accepts standard two-pin PL-10 plug

BULK P/N	POLYPACK P/N	DESCRIPTION	QTY
UTILITY LIGHT - 9 DIODES			
UCL50CB	UCL50CBP	12-24VDC Utility light	20

ACCESSORIES			
A46PB	A46PBP	Straight plug, 6" lead	100
A86PB	A86PBP	Straight plug, 18" lead	100
A54GB	A54GBP	2" Flush mount grommet	100
A54GK	A54GKP	2" Kit: A54GB and A46PB	100
A55CB	A55CBP	2" Chrome trim ring	20
BK5557GB	BK5557GBP	Cam-on mounting bracket	50

MATERIALS	Polycarbonate lens and housing
VOLT/AMP	12.8VDC - 0.013A
WT/DIMS	.088 lb. / 2" x 2" x 1.188"
WARRANTY	Lifetime LED Warranty



UCL50CB

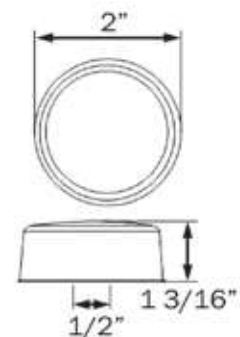



UCL55CB

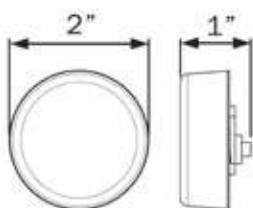

UCL55 SERIES 2" Sealed LED Utility Light

- Sonically sealed, waterproof
- Accepts standard two-pin PL-10 plug

BULK P/N	POLYPACK P/N	DESCRIPTION	QTY
UTILITY LIGHT - 3 DIODES			
UCL55CB	UCL55CBP	Utility light	20
ACCESSORIES			
A46PB	A46PBP	Straight plug, 6" lead	100
A86PB	A86PBP	Straight plug, 18" lead	100
A54GB	A54GBP	2" Flush mount grommet	100
A54GK	A54GKP	2" Kit: A54GB and A46PB	100
A55CB	A55CBP	2" Chrome trim ring	20
BK5557GB	BK5557GBP	Cam-on mounting bracket	50

MATERIALS	Polycarbonate lens and housing
VOLT/AMP	12.8VDC - 0.047A
WT/DIMS	.088 lb. / 2" x 2" x 1"
WARRANTY	Lifetime LED Warranty



UCL65CB



UCL65 SERIES Sealed LED Thinline Utility Light

- Sealed, waterproof
- Multiple mounting and wiring options available

BULK P/N	POLYPACK P/N	DESCRIPTION	QTY
UTILITY LIGHT - 6 DIODES			
UCL65CB	UCL65CBP	Utility light	20
ACCESSORIES			
A65B	A65BP	Black bracket	50
A65P	A65PP	Single wire plug, .156 male bullet	50
A65PB	A65PBP	Kit: A65B black bracket & A65P plug	50
A66PB	A66PBP	Kit: Gray bracket & A65P plug	50
A67CB	A67CBP	Kit: Chrome bracket & A65P plug	50
A68PB	A68PBP	Kit: Black bracket & 2-wire plug	50

For more details on mounting and wiring accessories, see Accessories section at back of catalog.

MATERIALS	Polycarbonate lens and housing
VOLT/AMP	12.8VDC - 0.048A
WT/DIMS	.066 lb. / 3.875" x 1.25" x 1.125"
WARRANTY	Lifetime LED Warranty

UCL60/160 SERIES Sealed LED Utility Light

- Sealed, waterproof
- Compact, surface mount design
- Design includes both lead and ground wire
- CSA certified for use in sleeping quarters
- Snap-on trim ring included, multiple finishes available

BULK P/N	POLYPACK P/N	DESCRIPTION	QTY
TOUCH SWITCH UTILITY LIGHT - 6 DIODES			
UCL60CSBB	UCL60CSBBP	Utility light, black trim ring	20
UCL60CSNB	UCL60CSNBP	Utility light, brushed nickel trim ring	20
UCL60CSWNB	UCL60CSWNBP	Utility light, warm white LED, brushed nickel trim ring	20
UTILITY LIGHT, NO SWITCH - 6 DIODES			
UCL60CB	UCL60CBP	Utility light, chrome trim ring	20
UCL60CSCB	-	Utility light, chrome trim ring, Delphi connector	20
UCL60CBB	UCL60CBBP	Utility light, black trim ring	20

Raw lumen output: 224 lm
Effective lumen output: 168 lm

BULK P/N	POLYPACK P/N	DESCRIPTION	QTY
GLOLIGHT™ UTILITY LIGHT - 6 DIODES			
UCL160CB	UCL160CBP	Utility light, chrome trim ring	20

Raw lumen output: 224 lm
Effective lumen output: 168 lm

MATERIALS	Polycarbonate lens and housing
VOLT/AMP	12.8VDC - 0.020A
WT/DIMS	.088 lb. / 3" x 3" x .375"
WARRANTY	Lifetime LED Warranty

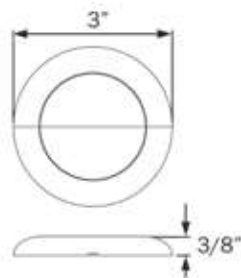



ILLO1 SERIES 3/4" LED Emergency Egress Light



- 3/4" recess mount light for use in transit vehicles
- Hard wired, includes lead and ground with female Staykon connectors
- Sealed, waterproof construction – maintenance free
- Snap-in design for quick and easy installation

BULK P/N	BOX/UPC P/N	DESCRIPTION	QTY
EGRESS LIGHT - 1 DIODE			
ILLO1RB	ILLO1RBP	3/4" egress light	50

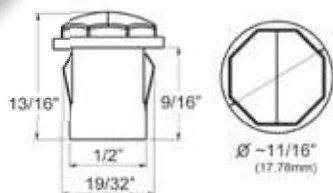

MATERIALS	Polycarbonate lens and housing
VOLT/AMP	12.8VDC - .1A
WT/DIMS	0.018 lb. / .695" x .695" x .81"
WARRANTY	Lifetime LED Warranty



ILLO6/07 SERIES Opti-Brite™ LED Mini Dome Light



ILL06COB

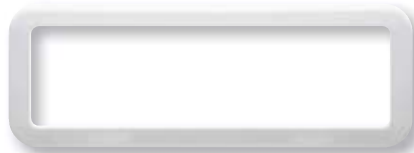

A06TR

- Compact 11-inch dome light fits many applications
- Design includes 6-inch, 16-gauge power and ground wires with tinned ends
- Available with neutral white or cool white LEDs

BULK P/N	POLYPACK P/N	DESCRIPTION	QTY
COOL WHITE - 16 DIODES			
ILL06COB	ILL06COBP	Dome light, white trim ring	12
ILL06COPG	ILL06COPGP	Dome light, .180 bullets, white trim ring	12
NEUTRAL WHITE - 16 DIODES			
ILL07COB	ILL07COBP	Neutral white LEDs	12
ACCESSORIES			
A06TR	A06TRP	White trim ring	50

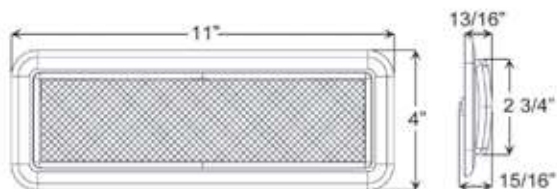

Raw lumen output: 643 lm
Effective lumen output: 354 lm

MATERIALS	Polycarbonate lens and housing
VOLT/AMP	12.8VDC - .48A
WT/DIMS	.05 lbs. / 11" x 4" x .94"
WARRANTY	Lifetime LED Warranty

ILLO8 SERIES

Opti-Brite™ LED Dome Lights

- Designed for use in extreme temperatures; ideal for refrigerated trucks and trailers (-40 to 140 degrees F)
- Operating voltage 7-30VDC; voltage cut-off at 7VDC prevents battery drain
- Use with both 12VDC and 24VDC systems; light output remains consistent at all operating voltages (no dimming), cutting off when voltage is outside range
- Design includes 16-inch, 16-gauge power and ground wires with tinned ends



ILL08COB



ILL28CMB



BULK P/N	BOX/UPC P/N	DESCRIPTION	QTY
DOMES LIGHT - 8 DIODES			
ILL08COB	ILL08COBP	Light	6
ILL08COPG	ILL08COPGP	Light, .180 male bullets,	6
MOTION SENSOR DOME LIGHT - 8 DIODES			
ILL28CMB	ILL28CMBP	Light with motion sensor	6
ILL28CMPG	ILL28CMPGP	Light with motion sensor, .180 male bullets	6

Raw lumen output: 1400 lm
Effective lumen output: 990 lm

MATERIALS	Polycarbonate lens and housing
VOLT/AMP	12.8VDC - 1.61A; 24VDC - 0.80A
WT/DIMS	1 lb. / 18.25" x 5.75" x 1.078"
WARRANTY	Lifetime LED Warranty

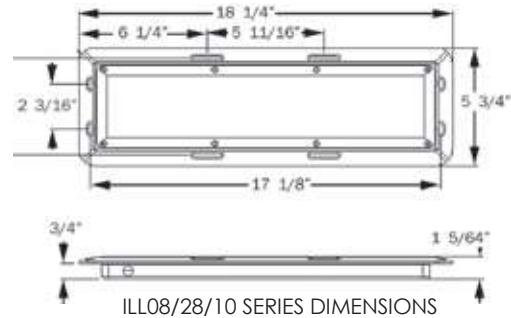

ILL10 SERIES

Opti-Brite™ LED Dome Light

For 12VDC systems, general applications

BULK P/N	BOX/UPC P/N	DESCRIPTION	QTY
DOMES LIGHT - 10 DIODES			
ILL10CCB	ILL10CCBP	11-16VDC Dome light	6

Raw lumen output: 1100 lm
Effective lumen output: 880 lm

MATERIALS	Polycarbonate lens and housing
VOLT/AMP	12.8VDC - 1.8A
WT/DIMS	1 lb. / 18.25" x 5.75" x 1.078"
WARRANTY	Lifetime LED Warranty



ILL10CCB

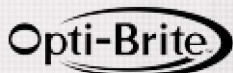

ILL21CB

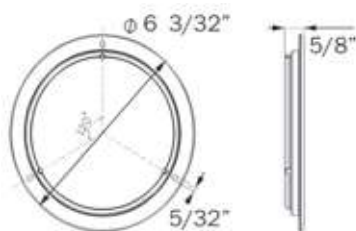

ILL21 SERIES Opti-Brite™ LED 6" Dome Light

- Low profile dome light – less than 5/8" thick
- Operating voltage 12-24VDC; use with both 12VDC and 24VDC systems
- Low voltage cut-off at 11VDC, prevents battery drain
- Sealed, waterproof

BULK P/N	POLYPACK P/N	DESCRIPTION	QTY
DOMELIGHT - 21 DIODES			
ILL21CB	ILL21CBP	Dome light, two-wire, .180 male bullets	10
ILL21CTPB	-	ILL21CB with adhesive mounting pad	10
A21CHB	-	Chrome trim ring	25

Raw lumen output: 250 lm
Effective lumen output: 214 lm

MATERIALS	Polycarbonate lens and housing
VOLT/AMP	12.8VDC - .408A; 24VDC - .385A
WT/DIMS	.250 lb. / 6.0938" x 6.0938" x .625"
WARRANTY	Lifetime LED Warranty



ILL39CB

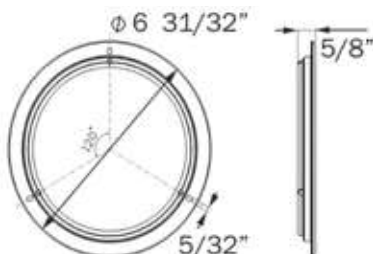

ILL39 SERIES Opti-Brite™ LED 7" Dome Light

- Low profile dome light – less than 5/8" thick
- Operating voltage 12-24VDC; use with both 12VDC and 24VDC systems
- Low voltage cut-off at 11VDC, prevents battery drain
- Hard wired design includes 16-gauge power and ground wires with .180 male bullets
- Sealed, waterproof

BULK P/N	POLYPACK P/N	DESCRIPTION	QTY
DOMELIGHT - 39 DIODES			
ILL39CB	ILL39CBP	Dome light	5/10

Raw lumen output: 460 lm
Effective lumen output: 390 lm

MATERIALS	Polycarbonate lens and housing
VOLT/AMP	12.8VDC - .669A; 24VDC - .217A
WT/DIMS	.350 lb. / 6.969" x 6.969" x .625"
WARRANTY	Lifetime LED Warranty

ILL25/26 SERIES LED Low Profile Interior Lights



PATENTED TECHNOLOGY

- Low profile dome lights
- Surface mount
- Hard wired design includes both lead and ground wire

BULK P/N	POLYPACK P/N	DESCRIPTION	QTY
DOMELIGHT - 12 DIODES			
ILL25CB	ILL25CBP	Interior light, 3.5"	20

Raw lumen output: 400 lm
Effective lumen output: 260 lm

BULK P/N	POLYPACK P/N	DESCRIPTION	QTY
DOMELIGHT - 18 DIODES			
ILL26CB	ILL26CBP	Interior light, 4.5"	10

Raw lumen output: 600 lm
Effective lumen output: 390 lm

MATERIALS	Polycarbonate lens and housing
VOLT/AMP	ILL25CB: 12.8VDC - .32A ILL26CB: 12.8VDC - .42A
WT/DIMS	ILL25CB: .097 lb. / 3.50" x 3.50" x .75" ILL26CB: .156 lb. / 4.50" x 4.50" x .875"
WARRANTY	Lifetime LED Warranty

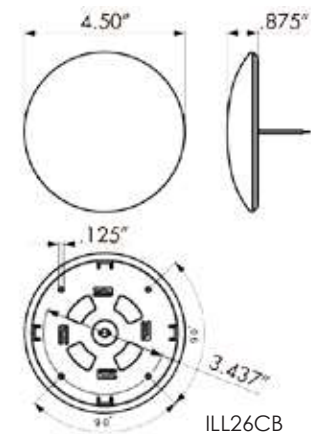
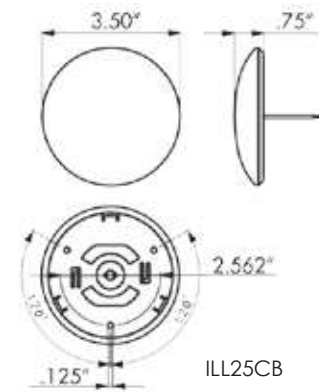

LED INTERIOR/UTILITY LIGHTS

ILL22 SERIES Sealed LED Dome Lights

- Low profile dome lights – only 1" thick
- Sealed, waterproof design
- Hard wired with 6" power and ground wires



ILL22CB

BULK P/N	POLYPACK P/N	DESCRIPTION	QTY
DOMELIGHT - 18 DIODES			
ILL22CB	ILL22CBP	Dome light, on/off switch	10
ILL22CHB	ILL22CHBP	Dome light, no switch	10

Raw lumen output: 1044 lm
Effective lumen output: 810 lm

MATERIALS	Polycarbonate lens and housing
VOLT/AMP	12.8VDC - .7A
WT/DIMS	.182 lb. / 4.5" x 2.875" x 1"
WARRANTY	Lifetime LED Warranty

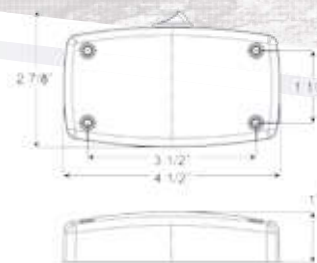

ILL24 SERIES Sealed LED 6" Dome Light

- Low profile dome light – only 7/8" thick
- Sealed, waterproof
- Hard wired design includes power and ground wires



ILL24CB

BULK P/N	POLYPACK P/N	DESCRIPTION	QTY
DOMELIGHT - 24 DIODES			
ILL24CB	ILL24CBP	Dome light	10

Raw lumen output: 585 lm
Effective lumen output: 453 lm

MATERIALS	Polycarbonate lens and housing
VOLT/AMP	12.8VDC - .127A
WT/DIMS	.353 lb. / 6.125" x 6.125" x 0.875"
WARRANTY	Lifetime LED Warranty

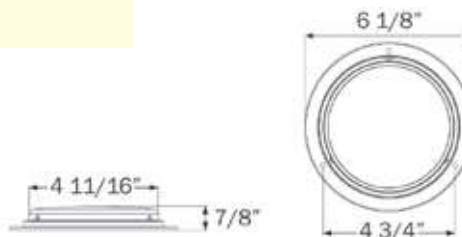

ILL30CBB SERIES Constellation™ LED Bullet Light



- Surface mount fixture; trim ring covers mounting hardware
- Ratchet motion design with on/off switch
- Lightly frosted lens
- Hard wired design includes power and ground wires



ILL30CBB

BULK P/N	POLYPACK P/N	DESCRIPTION	QTY
BULLET LIGHT - 1 DIODE			
ILL30CBB	ILL30CBBP	Bullet light	25

MATERIALS	Plastic housing
VOLT/AMP	12.8VDC - .288A
WT/DIMS	.250 lb. / 3.75" x 1.938" x 3.5"
WARRANTY	Lifetime LED Warranty

ILL31/32/35 SERIES LED Low Profile Dome Lights



- Low profile dome lights for semi-recess or surface mount
- Durable steel housing and replaceable polycarbonate lens
- Hard wired design includes power and ground wires
- Select from standard diode or SMD LED models



ILL31CB

BULK P/N	POLYPACK P/N	DESCRIPTION	QTY
RECESS MOUNT DOME LIGHT - 10 DIODES			
ILL31CB	ILL31CBP	Standard LED	10
ILL35CB	-	SMD LED	10
SURFACE MOUNT DOME LIGHT - 10 DIODES			
ILL32CB	ILL32CBP	SMD LED	10
ILL32CPG	-	SMD LED, .180 male bullets	10

Raw lumen output: 70 lm
Effective lumen output: 53 lm

MATERIALS	Polycarbonate lens, plated steel housing
VOLT/AMP	12.8VDC - .024A
WT/DIMS	ILL31/35: .243 lb. / 5.75" x 2.75" x .938" ILL32: .243 lb. / 5.75" x 2.75" x .75"
WARRANTY	Lifetime LED Warranty

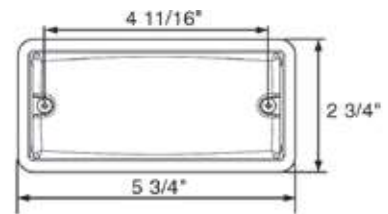

ILL31/32/35



ILL31/35 - recess mount



ILL32 - surface mount



ILL33CB

ILL33 SERIES Opti-Brite™ LED Sealed Dome Light

- Low profile surface mount design – less than 3/4" thick
- Hard wired design includes 18-gauge lead wires
- Sealed, waterproof

BULK P/N	POLYPACK P/N	DESCRIPTION	QTY
DOMELIGHT - 10 DIODES			
ILL33CB	ILL33CBP	Dome light	10

Raw lumen output: 210 lm
Effective lumen output: 160 lm

MATERIALS	Polycarbonate lens and housing
VOLT/AMP	12.8VDC - .147A
WT/DIMS	.154 lb. / 5.125" x 2.25" x .75"
WARRANTY	Lifetime LED Warranty

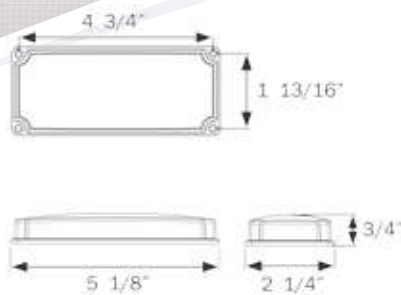

ILL36CB

ILL36 SERIES Opti-Brite™ LED Sealed Dome Light

- Low profile surface mount design – less than 3/4" thick
- Sealed, waterproof
- Durable polycarbonate construction

BULK P/N	POLYPACK P/N	DESCRIPTION	QTY
DOMELIGHT - 9 DIODES			
ILL36CB	ILL36CBP	Dome light	10
ILL36CPG	ILL36CPGP	Dome light, .180 male bullets	10

Raw lumen output: 400 lm
Effective lumen output: 227 lm

MATERIALS	Polycarbonate lens and housing
VOLT/AMP	12.8VDC - .33A
WT/DIMS	.154 lb. / 5.75" x 2.75" x .688"
WARRANTY	Lifetime LED Warranty

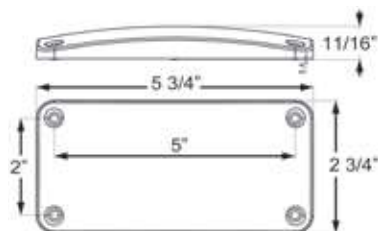

ILL45 SERIES Opti-Brite™ LED Interior Light



- Low profile surface mount design – less than 1" thick
- Durable polycarbonate construction



ILL45CB

BULK P/N	POLYPACK P/N	DESCRIPTION	QTY
INTERIOR LIGHT - 42 DIODES			
ILL45CB	ILL45CBP	Interior light	50

Raw lumen output: 300 lm
Effective lumen output: 260 lm

MATERIALS	Polycarbonate lens and housing
VOLT/AMP	12.8VDC - .37A
WT/DIMS	.206 lbs. / 4.625" x 4.625" x .79"
WARRANTY	Lifetime LED Warranty

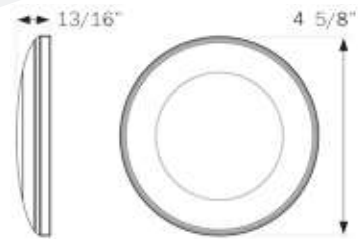

ILL46 SERIES Opti-Brite™ Sealed LED Dome Light

- Low profile surface mount design – less than 3/4" thick
- Sealed, waterproof
- Durable polycarbonate construction

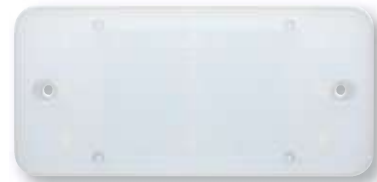

ILL46CB

BULK P/N	POLYPACK P/N	DESCRIPTION	QTY
DOMELIGHT - 9 DIODES			
ILL46CB	ILL46CBP	Dome light	10

Raw lumen output: 540 lm
Effective lumen output: 380 lm

MATERIALS	Polycarbonate lens and housing
VOLT/AMP	12.8VDC - .33A
WT/DIMS	.154 lbs. / 5.75" x 2.75" x .688"
WARRANTY	Lifetime LED Warranty

