

AN INTRODUCTION TO...

BODY SHOP FASTENERS

ATTACHES À CARROSSERIE

...UNE INTRODUCTION.

www.hpaulin.com

For a full listing of Papco® Body Shop Fasteners, please refer to our current catalogue or visit our website to download a PDF version.



SPEED CLIPS & NUTS

'PALNUTS'

RETAINERS

'PUSHNUT' METRIC FASTENERS

'U' NUTS (MULTI & SINGLE THREADS)

BODY BOLTS

BUMPER BAR BOLTS

'CONELOK' LOCKNUTS

LICENCE PLATE BOLTS

MOULDING BOLTS & CLIPS

RIVETS

GLASS SHOP FASTENERS

TRIM FASTENERS

WEATHERSTRIP FASTENERS

ANCHOR NUTS & CLIPS

PLUG BUTTONS

SHIMS

HINGE PINS & BUSHINGS

BLIND WELL NUTS

SERT-A-NUTS



FLAT TYPE SPEED NUTS
ÉCROUS TENIR TYPE FRAISÉE

240
 Series



Used with machine screws and sheet metal screws. One piece, heat treated spring steel self-locking fastener. The original equipment fastener used on headlights, radiators, moulding, trim, gravel deflectors, ornaments, emblems, name plates, etc.

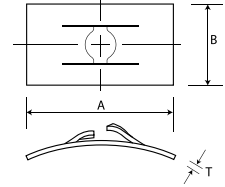

FLAT TYPE

ORDER BY STOCK NUMBER

Standard Package: Contains 100 Pieces



240-089
 240-100



240-091
 240-101



240-120
 240-159



240-108
 240-127

ILLUSTRATIONS ARE APPROXIMATE

| Stock No. | Screw Size | Dimensions | | | | | Other No. | Application |
|-----------|------------|------------|---|-------|---|------|-----------|---|
| | | A | x | B | x | T | | |
| 240-089 | 6-32 | 1/2 | x | 5/16 | x | .017 | 2089 | General Purpose. |
| 240-091 | 6-32 | 7/8 | x | 1/2 | x | .017 | 1898 | Chrysler products garnish moulding ornament. |
| 240-100 | 8-32 | 1/2 | x | 5/16 | x | .017 | 2091 | General Purpose. |
| 240-101 | 8-32 | 7/8 | x | 1/2 | x | .017 | 1899 | Chrysler products radiator and trunk medallion. |
| 240-120 | 10-24 | 3/4 | x | 7/16 | x | .022 | 2092 | General Purpose. |
| 240-159 | 1/4-20 | 1 | x | 9/16 | x | .027 | 1903 | General Purpose. |
| 240-108 | No. 8 | 5/8 | x | 11/32 | x | .031 | 3793 | For sheet metal screws. |
| 240-127 | No. 10 | 7/8 | x | 1/2 | x | .031 | 1900 | For sheet metal screws, and radiator grille. |

GARAGE ASSORTMENT

No. 020-015

Contains 8 sizes of Flat Type Speed Nuts, 160 pieces. Packed in handy, clear plastic box, with moulded compartments.



FORMED TYPE SPEED NUTS ÉCROUS TENIR TYPE FORME

240
Series

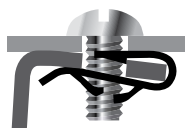

Used with machine screws and sheet metal screws. Two types, 'U' and 'J'. Press into locked on position over panel edge or in centre-panel location. Holds itself in screw receiving position.

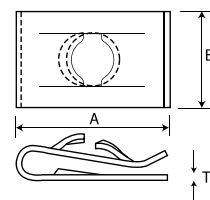

'J' Types

'U' Types



ILLUSTRATIONS ARE APPROXIMATE

ORDER BY STOCK NUMBER

Standard Package Contains 100 Pieces

| Stock No. | Screw Size | Type | Dimensions | | | | Other No. | Application | |
|-------------------------------|------------|------|------------|---|-------|---|-----------|-------------|---|
| | | | A | x | B | x | | | T |
| 240-243 | 10-24 | U | 41/64 | x | 7/16 | x | .020 | 5197 | General Purpose. |
| 240-263 | 1/4-20 | U | 63/64 | x | 1/2 | x | .025 | 2293 | Licence Plate attaching nut. |
| For Sheet Metal Screws | | | | | | | | | |
| 240-226 | No. 8 | U | 31/64 | x | 1/2 | x | .028 | 3796 | Chevrolet Headlamp adj. nut, radiator grille assembly. |
| 240-228 | No. 8 | U | 41/64 | x | 7/16 | x | .028 | 10666 | Ford quarter trim to panel. |
| 240-232 | No. 8 | U | 3/4 | x | 7/16 | x | .029 | 11292 | General purpose. |
| 240-242 | No. 10 | J | 1 | x | 1/2 | x | .035 | 8341 | General purpose. |
| 240-247 | No. 10 | J | 15/32 | x | 11/16 | x | .031 | 2303 | Chevrolet Headlamp to fender. |
| 240-250 | No. 10 | U | 3/4 | x | 1/2 | x | .031 | 2422 | Ford radiator grille. |
| 240-266 | No. 12 | U | 7/8 | x | 9/16 | x | .034 | 1910 | General purpose. |
| 240-267 | No. 14 | J | 7/8 | x | 9/16 | x | .034 | 2420 | Oldsmobile. front fender radiator to grille 3/32 panel. |
| 240-268 | No. 14 | J | 7/8 | x | 9/16 | x | .034 | 2057 | Oldsmobile. Pontiac, fender and radiator 3/64 panel. |
| 240-274 | 1/4-20 | J | 7/8 | x | 5/8 | x | .300 | 5586 | General purpose 'J' Type Cage Nut |
| 240-276 | 5/16-18 | J | 1-1/16 | x | 3/4 | x | .300 | 5589 | General purpose 'J' Type Cage Nut |
| 240-278 | 3/8-16 | J | 1-1/8 | x | 3/4 | x | .300 | 5170 | General purpose 'J' Type Cage Nut |

GARAGE ASSORTMENT

No. 020-016

Contains 8 sizes of 'U' and 'J' Formed Type Speed Nuts, 65 pieces. Packed in handy, clear plastic box with compartments.



**PUSH-ON TYPE SPEED NUTS
ÉCROUS TENIR TYPE POUSSÉE**

**240
Series**



For use on studs, rivets and other unthreaded parts. Teeth bite inward and arched shape provides secure spring grip.

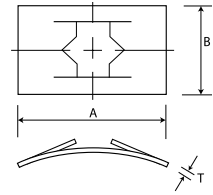

FLAT TYPE

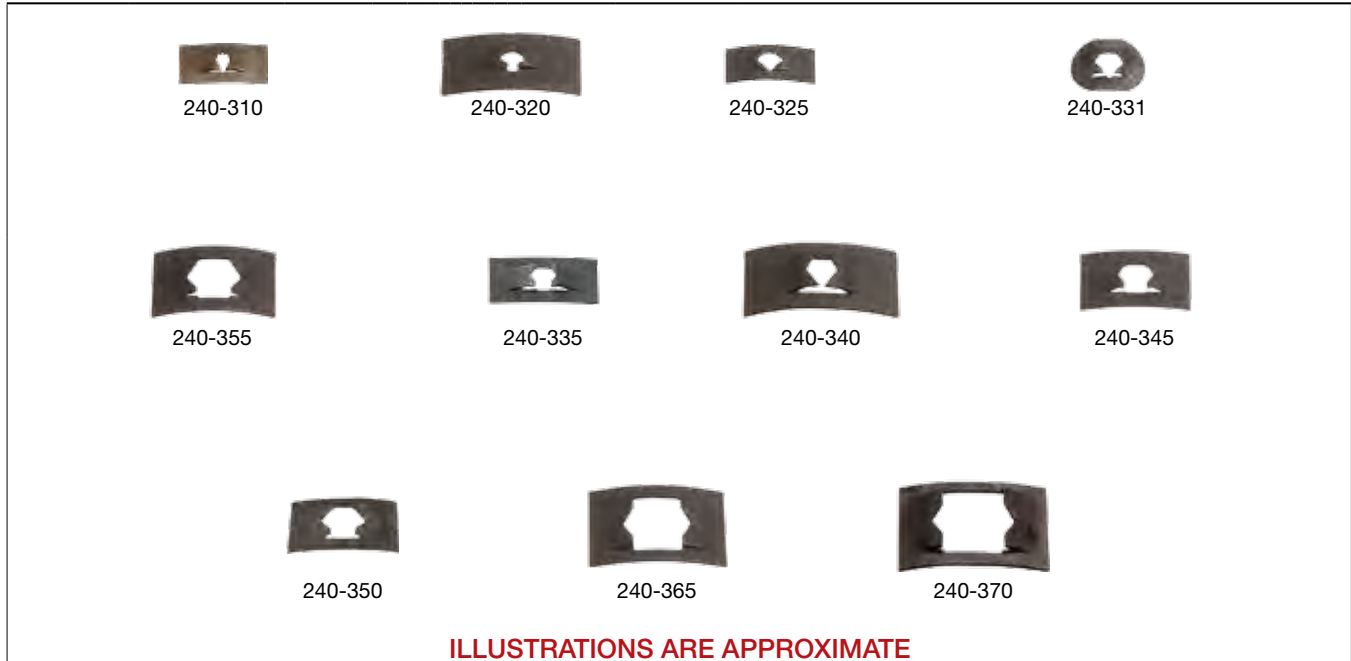

ORDER BY STOCK NUMBER

Standard Package Contains 100 Pieces

| Stock No. | Screw Size | Dimensions | | | | | Other No. | Application |
|-----------|------------|------------|---|-------|---|------|-----------|---|
| | | A | x | B | x | T | | |
| 240-310 | 1/16 | 25/64 | x | 7/32 | x | .012 | 2098 | Buick seat trim, Chrysler name plate. |
| 240-320 | 3/32 | 7/16 | x | 7/32 | x | .017 | 2100 | For Hardened Studs, Pontiac name plate. |
| 240-325 | .100 | 29/64 | x | 15/64 | x | .014 | 1906 | General Purpose. |
| 240-331 | 1/8 | 3/8 | x | 11/32 | x | .019 | 3559 | General Purpose. |
| 240-335 | 1/8 | 37/64 | x | 5/16 | x | .012 | 2099 | General Purpose. |
| 240-340 | 5/32 | 3/4 | x | 7/16 | x | .020 | 1905 | General Purpose. |
| 240-345 | 5/32 | 9/16 | x | 3/8 | x | .012 | 2102 | General Purpose. |
| 240-350 | 3/16 | 5/8 | x | 3/8 | x | .017 | 2103 | Ford products name plate, ornament. |
| 240-355 | 1/4 | 41/64 | x | 7/16 | x | .017 | 2105 | General Purpose. |
| 240-365 | 5/16 | 3/4 | x | 17/32 | x | .020 | 3138 | General Purpose. |
| 240-370 | 3/8 | 13/16 | x | 5/8 | x | .020 | 3139 | General Purpose. |

GARAGE ASSORTMENT

No. 020-017

Contains 7 sizes of Push-On Type Speed Nuts, 160 pieces. Packed in a rigid clear plastic container with handy compartments.



TUBULAR TYPE SPEED CLIPS ÉCROUS TENIR TYPE À TUBE

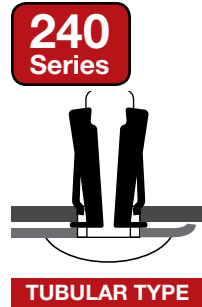

Used on unthreaded studs and rivets where there is access to only one side of the assembly. Insert speed clips into hole causing cam-like side prongs to snap and hold clip in proper position. Push rivet end into clip causing turned-in end of clip to bite rivet and lock it securely.

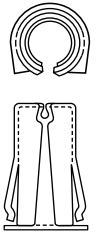

ORDER BY STOCK NUMBER

Standard Package: contains 100 Pieces



ILLUSTRATIONS ARE APPROXIMATE

| Stock No. | Stud Dia. | Panel Range | Fits Hole | Other No. | OEM No. |
|-----------|-----------|-------------|-----------|-----------|----------------------|
| 240-430 | 1/8 | .030 - .036 | 5/32 | 2611 | — |
| 240-431 | 1/8 | .040 - .045 | 3/16 | 2595 | — |
| 240-432 | 1/8 | .036 - .046 | 1/4 | 5195 | 375480-S100, 3783794 |
| 240-471 | 3/16 | .038 - .044 | 7/32 | 10073 | 6000558 |

GARAGE ASSORTMENT

No. 020-018

Contains 4 sizes of Tubular Speed Clips, for studs, 70 pieces. Packed in clear plastic container with easy to use compartments.

020-018



UTILITY ASSORTMENTS

No. 020-315

FLAT TYPE

8 sizes for Machine and Sheet Metal Screws, 325 pieces.



020-315

No. 020-316

FORMED TYPE

10 sizes, 'U' and 'J' types for Machine and Sheet Metal Screws, 110 pieces.



020-316

No. 020-317

PUSH-ON & TUBULAR

14 sizes for unthreaded Studs, 275 pieces.



020-317

All Papco[®] Utility Assortments are packed in sturdy fibreboard metal-edged boxes with individual compartments and with illustrated labels showing parts and prices.

**SPEED NUT MASTER ASSORTMENTS
ASSORTIMENTS D'ÉCROUS TENIR**

No. 020-643

For unthreaded studs. Contains 3 Sizes Tubular Speed Clips. 14 Sizes Push-On Speed Nuts. 477 pieces selected according to popularity. Name plates, emblems, moulding clips are held with Tubular Speed Clips and Push-on Speed Nuts. These kits will service every need that will come up in your shop.

020-643



No. 020-644

For machine and sheet metal screws. Contains 8 Sizes Flat Type Speed Nuts, 11 Sizes Formed Type Speed Nuts 421 pieces balanced for popularity. Every year more and more Speed Nuts are used for Original Equipment attachments. These handy kits contain the Speed Nuts that are most frequently replaced on all makes of cars. Size: 9-34" W x 13-3/4" L x 2" D.

020-644



**SPEED NUT 'SUPER-SERVICE' ASSORTMENT
ASSORTIMENT DE 'SUPER-SERVICE' D'ÉCROUS TENIR**

No. 020-810

Ideal for Dealers, Jobbers and large users. This popular assortment contains a wide range of Flat Push-on and Formed Type Speed Nuts carefully selected in balanced quantities.

Size: 12" W x 18" L x 3" D.

- Contains 685 Speed Nuts in Flat, Push-on and Formed Types – 32 sizes.
- Large size, rigid metal box with high-strength plastic compartments.
- Convenient, safety snap carrying handle.
- Actual size illustrations and retail codes of every item shown on grease-resistant lid label.
- Refills available in standard packages.

020-810



'PALNUT' LOCK NUTS ÉCROUS À BLOCAGE 'PALNUT'

242
Inch

243
Metric

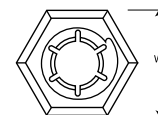

Regular Type, Bright Zinc Plated

Spring steel, single thread lock nuts. May be used alone or on top of ordinary nuts.

ORDER BY STOCK NUMBER

Standard Package: 50 Pieces

| Stock No. | Size & Thread | Across Flats 'W' | Stock No. | Size | Across Flats 'W' |
|-----------|---------------|------------------|-----------|------|------------------|
| Inch | | | Metric | | |
| 242-016 | 5/16-24 | 1/2 | 243-004 | M4 | 9 mm |
| 242-018 | 3/8-24 | 9/16 | 243-005 | M5 | 13 mm |
| 242-020 | 7/16-20 | 5/8 | | | |
| 242-022 | 1/2-20 | 3/4 | | | |

Hex Washer Type, Bright Zinc Plated

Integral washers on these lock nuts span slots or clearance holes. This spring locking action of the washer provides a secure assembly.

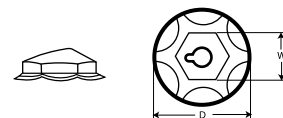

ORDER BY STOCK NUMBER

Standard Package: 50 Pieces

| Stock No. | Size & Thread | 'W' x 'D' | Stock No. | Size | 'W' x 'D' |
|-----------|---------------|--------------|-----------|------|---------------|
| Inch | | | Metric | | |
| 242-108 | 8-32 | 11/32 x 5/8 | 243-105 | M5 | 10 mm x 13 mm |
| 242-110 | 10-24 | 3/8 x 3/4 | 243-106 | M6 | 11 mm x 18 mm |
| 242-114 | 1/4-20 | 7/16 x 11/16 | | | |
| 242-116 | 5/16-18 | 1/2 x 13/16 | | | |

GARAGE ASSORTMENT

No. 020-074

Contains 100 pieces of all Inch sizes of 'Palnut' Lock Nuts in both regular and washer types. Packed in a clear, plastic box.

No. 020-075

Contains 100 pieces of all Metric size 'Palnut' Lock Nuts in both regular and washer types. Packed in a clear, plastic box.

020-075



SELF-THREADING 'PALNUTS' 'PALNUTS' À FILETAGE COUPANT

These washer base, heat treated nuts cut their own threads on plain studs, nameplates, ornaments and mouldings.

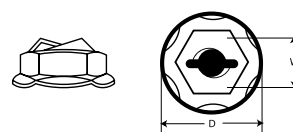

ORDER BY STOCK NUMBER

Standard Package: 50 Pieces

| Stock No. | Stud Size | Type | 'W' x 'D' | Stock No. | Stud Size | Type | 'W' x 'D' |
|--------------------|-----------|---------|--------------|--------------------|-----------|---------|--------------|
| Bright Zinc plated | | | | Bright Zinc plated | | | |
| 242-206 | 1/8 | Regular | 5/16 x 7/16 | 242-214 | 1/4 | Regular | 7/16 x 11/16 |
| 242-208 | 5/32 | Regular | 11/32 x 9/16 | 242-216 | 5/16 | Regular | 1/2 x 7/8 |
| 242-210 | 3/16 | Regular | 3/8 x 1/2 | | | | |

METRIC SELF-THREADING 'PALNUTS' 'PALNUTS' À FILETAGE COUPANT MÉTRIQUE

ORDER BY STOCK NUMBER

Standard Package: 50 Pieces

| Stock No. | Stud Size | Type | W x D | Stock No. | Stud Size | Type | W x D |
|--------------------|-----------|---------|--------------|-----------|-----------|---------|---------------|
| Bright Zinc plated | | | | | | | |
| 243-204 | 4 mm | Regular | 9 mm x 15 mm | 243-205 | 5 mm | Regular | 10 mm x 15 mm |

GARAGE ASSORTMENT

No. 020-052

Contains 100 nuts of 1/8", 5/32", 3/16", 1/4" and 5/16" Self-Threading 'Palnuts'. Packed in a clear, plastic box.

020-052



**BOLT RETAINERS
RETENUES DE BOULON**

242
Inch

243
Metric

Black Phosphate Finish

These fasteners are pushed onto a screw or bolt of either coarse or fine thread to hold it in place during assembly. When the regular nut is tightened the retainer is left in place.

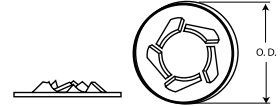

ORDER BY STOCK NUMBER

Standard Package: 100 Pieces

| Stock No. | Screw or Bolt Dia. | Outside Diameter |
|-----------|--------------------|------------------|
| Inch | | |
| 242-308 | 5/32 | 3/8" |
| 242-310 | 3/16 | 7/16" |
| 242-314 | 1/4 | 1/2" |
| 242-316 | 5/16 | 5/8" |
| 242-318 | 3/8 | 25/32" |
| 242-320 | 7/16 | 27/32" |
| 242-322 | 1/2 | 15/16" |

| Stock No. | Screw or Bolt Dia. | Outside Diameter |
|-----------|--------------------|------------------|
| Metric | | |
| 243-305 | M5 | 11.0 mm |
| 243-306 | M6 | 17.0 mm |
| 243-307 | M6.3 | 14.3 mm |
| 243-308 | M8 | 25.0 mm |
| 243-310 | M10 | 24.0 mm |
| 243-312 | M12 | 21.4 mm |

GARAGE ASSORTMENT

No. 020-076

Contains 100 inch retainers in 1/4", 5/16", 3/8", 7/16" and 1/2". Packed in a sturdy, transparent plastic box.

No. 020-077

Contains 100 metric retainers in M6, M8, M10 and M12. Packed in a clear, plastic, compartmentalized box.



020-077

**'PUSHNUT' FASTENERS
ATTACHES 'PUSHNUT'**

Bright Zinc Plated

These flat, round type, spring steel fasteners are pushed on unthreaded rods, studs, etc. Used on nameplates, moulding studs and shafts.

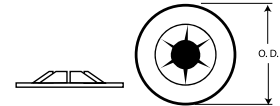

ORDER BY STOCK NUMBER

Standard Package: 100 Pieces

| Stock No. | Stud Size | Outside Diameter | Stock No. | Stud Size | Outside Diameter |
|-----------|-----------|------------------|-----------|-----------|------------------|
| 242-401 | 1/16 | .195 | 242-413 | .240 | 17/32 |
| 242-403 | 3/32 | .195 | 242-414 | 1/4 | 17/32 |
| 242-406 | 1/8 | 3/8 | 242-416 | 5/16 | 5/8 |
| 242-408 | 5/32 | 7/16 | 242-418 | 3/8 | 3/4 |
| 242-410 | 3/16 | 7/16 | 242-422 | 1/2 | 1 |

**METRIC 'PUSHNUT' FASTENERS
ATTACHES 'PUSHNUT' MÉTRIQUE**

ORDER BY STOCK NUMBER

Standard Package: 100 Pieces

| Stock No. | Stud Size | Outside Diameter | Stock No. | Stud Size | Outside Diameter |
|-----------|-----------|------------------|-----------|-----------|------------------|
| 243-403 | 3.2 mm | 9.5 mm | 243-405 | 5.0 mm | 11.0 mm |
| 243-404 | 4.0 mm | 11.0 mm | | | |

GARAGE ASSORTMENT

No. 020-084

Contains 100 'Pushnut' Fasteners in both inch and metric - 10 sizes in all. Packed in a transparent plastic box with hinged lid.

020-084



MASTER ASSORTMENT

No. 020-674

Contains 325 pieces - 20 popular sizes of Regular and Self-Threading Palnuts plus Bolt Retainers and 'Pushnuts'. Packed in a Metal box with moulded plastic compartments.

020-674

9-3/4" W x 13-3/4" L x 2" D.



'SUPER-SERVICE' ASSORTMENT

No. 020-811

Contains 500 Regular and Self Threading Palnuts plus Bolt Retainers and 'Pushnuts' - 32 items. Large size, rigid metal box with high-strength plastic compartments.

020-811

18" L x 3" D.



**MULTI-THREAD 'U' NUTS
ÉCROUS 'U' FILET MULTIPLE**

240
Inch

241
Metric

Phosphate Coated
Spring Steel nut fastens two panels, is retained in one panel. Used for sheet metal and front end assembly on GM, Ford or Chrysler fenders, shrouds and radiators, etc.

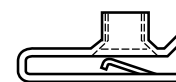
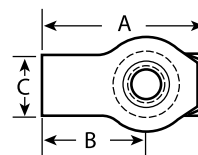

ORDER BY STOCK NUMBER

Standard Package: 25 Pieces (*10 Pieces)

| Stock No. | Bolt or Screw Size | Length 'A' | Throat Depth 'B' | Width 'C' | Panel Thickness | OEM No. | Stock No. | Bolt or Screw Size | Length 'A' | Throat Depth 'B' | Width 'C' | Panel Thickness | OEM No. |
|-----------|--------------------|------------|------------------|-----------|-----------------|-----------------------------|-----------|--------------------|------------|------------------|-----------|-----------------|--|
| | | | | | | | | | | | | | |
| 240-615 | 1/4-20 | 1.250 | 0.8125 | 0.520 | 0.150 | 45267, 1494257 | 241-605 | M4 x .7 | 22.0 | 14.5 | 10.0 | 3.8 | 11500655 |
| 240-616 | 5/16-18 | 0.980 | 0.580 | 0.580 | 0.150 | 6023171-45264 | 241-606 | M6 x 1.0 | 24.0 | 13.7 | 13.0 | 4.0 | 11503957, 1016937, N623332-S2, N623332-S53, N623332-S100 |
| 240-617 | 5/16-18 | 1.250 | 0.875 | 0.580 | 0.150 | 379831-S, 1494258 | 241-607 | M6 x 1.0 | 30.0 | 20.0 | 13.0 | 4.0 | 11503715, 11508241, 11609385 |
| 240-618 | 3/8-16 | 1.670 | 1.100 | 0.720 | 0.200 | 45269 | 241-608 | M8 x 1.25 | 32.0 | 21.5 | 14.7 | 4.0 | 11500661, 11503317, 11516150, N623343-S2, N623343-S100 |
| 240-619 | 3/8-16 | 1.3125 | 0.750 | 0.9375 | 0.200 | 1494254, 45265-S2, 12337873 | 241-609 | M8 x 1.25 | 25.5 | 15.0 | 14.7 | 4.0 | 11500660, 11502617, N623333-S2, 6101283 |
| 240-614 | 1/4-20 | 0.920 | 0.540 | 0.520 | 0.150 | 1480627, 1494252 | 241-610* | M10 x 1.5 | 33.0 | 19.0 | 18.0 | 6.0 | 11500662, 22531616 |
| 241-604 | M4 x .7 | 21.5 | 10.5 | 11.0 | 3.8 | N623330-S2, 11500654 | 241-612 | M6.3 x 1.0 | 24.0 | 20.0 | 13.5 | 4.0 | 11500658, 9433043 |

For Body Bolts see page 142.

GARAGE ASSORTMENT

No. 020-078

Contains 65 Inch Multi-Thread 'U' Nuts. 4 sizes each in its own compartment. Packed in a sturdy, transparent plastic box with hinged lid.

No. 020-079

Contains 50 Metric Multi-Thread 'U' Nuts. 7 sizes packed in a clear plastic box with hinged lid.



020-079

**SINGLE THREAD 'U' NUTS
ÉCROUS 'U' FILET-UNE**

240
Inch

Phosphate Coated

ORDER BY STOCK NUMBER

Standard Package: 25 Pieces

| Stock No. | Screw Size | Length 'A' | Throat Depth 'B' | Width 'C' | Panel Thickness | OEM No. | Stock No. | Screw Size | Length 'A' | Throat Depth 'B' | Width 'C' | Panel Thickness | OEM No. |
|-----------|------------|------------|------------------|-----------|-----------------|------------------------------|-----------|------------|------------|------------------|-----------|-----------------|----------|
| | | | | | | | | | | | | | |
| 240-706 | No. 6 | 0.890 | 0.375 | 0.575 | 0.125 | — | 240-714 | No. 14 | 0.785 | 0.344 | 0.650 | 0.156 | 45258 |
| 240-708 | No. 8 | 0.785 | 0.375 | 0.550 | 0.125 | 9424837, 9431530; 381818-S2 | 240-715 | No. 14 | 1.000 | 0.563 | 0.650 | 0.156 | 45261 |
| 240-709 | No. 8 | 1.000 | 0.625 | 0.550 | 0.125 | 9440178, 11504531, 381863-S2 | 240-717 | No. 8 | 0.430 | 0.219 | 0.325 | 0.109 | 25527289 |
| 240-710 | No. 10 | 0.785 | 0.344 | 0.650 | 0.125 | 152492 | 240-726 | M6.3 | 0.988 | 0.845 | 0.640 | 0.340 | — |

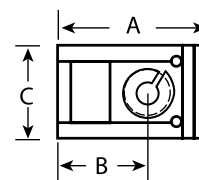

GARAGE ASSORTMENT

No. 020-080

Contains 65 Single Thread 'U' Nuts. 5 sizes packed in a transparent plastic box with hinged lid.



020-080

MASTER ASSORTMENT

No. 020-692

Contains 100 'U' Nuts in both Multi-Thread and Single Thread types. Packed in a metal box with high-strength plastic compartments. Total of 20 sizes inch, metric for complete coverage.



020-692

**BODY BOLTS
BOULONS DE CARROSSERIE**

**245
Series**

Special Indented Hexagon Head Bolts with aligning points for pre-drilled panels. Phosphate finish.



TYPE 1
Conical Washer
Head Dog-Point



TYPE 2
Conical
Washer Head



TYPE 3
Hex Washer
Head



TYPE 4
Hex Head
Sems

ORDER BY STOCK NUMBER

Standard Package: 25 Pieces (*15 Pieces)

| Stock No. | Size | Type | Washer O.D. | OEM No. | Stock No. | Size | Type | Washer O.D. | OEM No. |
|-----------|------------------|------|-------------|-----------------------------|-----------|--------------------|------|-------------|--------------------------|
| 245-310 | M4.2-1.41 x 20mm | 4 | 12mm | 11504056, 11513801 | 245-441 | M8-1.25 x 30mm | 3 | 17mm | 11500971 |
| 245-315 | M6-1.0 x 28mm | 1 | 8mm | N606677-S43B | 245-450* | M10-1.5 x 40mm | 2 | 29mm | 11501193 |
| 245-322 | M6-1.0 x 22mm | 1 | 8mm | N606676-S2, N606676-S100 | 245-505 | M6-1.0 x 20mm | 3 | 13mm | 11503800 |
| 245-323 | M6-1.0 x 28mm | 1 | 19mm | N606677-S36 | 245-507 | M6-1.0 x 25mm | 3 | 13mm | 11503958 |
| 245-324 | M6-1.0 x 30mm | 2 | 24mm | 11503825 | 245-510 | M6-1.0 x 35mm | 3 | 17mm | 11505044 |
| 245-325 | M6-1.0 x 30mm | 1 | 19mm | 6100568 | 245-525 | M8-1.25 x 25mm | 3 | 17mm | 11503632 |
| 245-326 | M5-0.8 x 20mm | 1 | 12mm | 6100539 | 245-526 | M8-1.25 x 25mm | 2 | 24mm | 11503619 |
| 245-400 | M4.2-1.41 x 20mm | 2 | 16mm | 11500434, 11503892, 1640810 | 245-527 | M8-1.25 x 30mm | 3 | 17mm | 11500971 |
| 245-405 | M6-1.0 x 20mm | 2 | 17mm | 11502941, 11506174 | 245-321 | 1/4-20 x 7/8" | 1 | 3/4" | 57030-S2 |
| 245-407 | M6-1.0 x 25mm | 2 | 17mm | 11503834, 20351035 | 245-610 | 1/4-20 x 1-1/4 S/S | 3 | 5/8" | 14007511, 367291, 474821 |
| 245-408 | M6-1.0 x 25mm | 2 | 24mm | 11503982 | 245-614 | 5/16-18x13/16" | 1 | 41/64" | 3960314 |
| 245-420 | M6.3-1.0 x 20mm | 2 | 17mm | 11501105 | 245-615 | 5/16-18 x 7/8" | 2 | 3/4" | 3846202 |
| 245-421 | M6.3-1.81 x 20mm | 4 | 18mm | — | 245-616 | 5/16-18 x 1" | 2 | 7/8" | 3968521 |
| 245-424 | M6.3-1.0 x 25mm | 2 | 18mm | 11500754 | 245-617 | 5/16-18 x 1" | 1 | 13/16" | — |
| 245-425 | M6.3-1.0 x 25mm | 2 | 24mm | 365718 | 245-620 | 3/8-16 x 1" | 2 | 1" | 3986997, 14011722 |
| 245-439 | M8-1.25 x 25mm | 2 | 24mm | 1503619 | 245-621 | 1/4-20 x 1" | 1 | 5/8" | 6025329 |
| 245-440 | M8-1.25 x 30mm | 2 | 24mm | 11501188 | 245-630 | 3/8-16 x 1-1/2" | 2 | 1-1/8" | 407217, 1564180 |

For Body Bolt 'U' Nuts see page 141.

MASTER ASSORTMENT

No. 020-691

Contains 150 Body Bolts - 20 sizes. Packed in a metal box with high-strength plastic compartments. Every item is fully illustrated on a grease resistant lid label.

For Body Bolt & Nuts 'Super-Service' Assortment No. 020-834 see page 11.

020-691

9-3/4" W x 13-3/4" L x 2" D.



BUMPER BAR BOLTS BOULONS DE PARE-CHOC

245
Series

Stainless Steel Capped

Papco® Bumper Bar Bolts are capped with 18.8 Stainless Steel, carefully polished and buffed to a high lustre. All bolts are bright plated to resist rust.



Type 1
Semi-Round
Head



Type 2
Round
Head

Standard Package: contains 12 Bumper Bar Bolts and 12 Self-Locking Nuts * 6 Bumper Bar Bolts and 6 Self-Locking Nuts

ORDER BY STOCK NUMBER

| Stock No. | Bolt Size | Type | Stock No. | Bolt Size | Type |
|-----------|----------------|------|-----------|-----------------|------|
| 245-146 | 1/4-20 x 3/4 | 1 | 245-172 | 7/16-14 x 1-1/4 | 1 |
| 245-150 | 5/16-18 x 7/8 | 1 | 245-173 | 7/16-14 x 1-1/2 | 1 |
| 245-153 | 5/16-18 x 1 | 1 | 245-175 | 7/16-14 x 2 | 1 |
| 245-160 | 3/8-16 x 3/4 | 1 | 245-177 | 7/16-14 x 2-1/2 | 1 |
| 245-161 | 3/8-16 x 3/4 | 2 | 245-179 | 7/16-14 x 3-1/2 | 1 |
| 245-164 | 3/8-16 x 1 | 1 | 245-182 | 1/2-13 x 1-1/4 | 1 |
| 245-165 | 3/8-16 x 1 | 2 | 245-183* | 1/2-13 x 1-1/2 | 1 |
| 245-167 | 3/8-16 x 1-1/4 | 1 | 245-184 | 1/2-13 x 1-3/4 | 1 |
| 245-170 | 7/16-14 x 7/8 | 1 | 245-185 | 1/2-13 x 2 | 1 |
| 245-171 | 7/16-14 x 1 | 1 | 245-190 | 9/16-12 x 1-1/2 | 1 |

GRADE B 'CONELOK' LOCKNUTS ÉCROUS À BLOCAGE 'CONELOK'

061
Series

Cadmium plated and waxed

These nuts lock in position when tightened with a wrench.



ORDER BY STOCK NUMBER

| Stock No. | Bolt Size | Standard Package | Stock No. | Bolt Size | Standard Package |
|-----------|-----------|------------------|-----------|-----------|------------------|
| 061-516 | 5/16-18 | 100 | 061-520 | 7/16-14 | 50 |
| 061-518 | 3/8-16 | 100 | 061-522 | 1/2-13 | 50 |

METRIC BUMPER BAR BOLTS BOULONS DE PARE-CHOC MÉTRIQUE

245
Series

Button Head Blue Zinc Plated



Type 1
Capped



Type 2
Uncapped

Standard Package: 10 Bolts and 10 Metric Pozi-Lok® Nuts.

ORDER BY STOCK NUMBER

| Stock No. | Bolt Size | Description | Type | Stock No. | Bolt Size | Description | Type |
|-----------|-------------------|---------------------|------|-----------|--------------------|---------------------|------|
| 245-220 | M8 x 1.25 x 25 mm | Chrome plated Cap | 1 | 245-223 | M8 x 1.25 x 27 mm | Uncapped | 2 |
| 245-221 | M8 x 1.25 x 20 mm | Uncapped | 1 | 245-233 | M10 x 1.5 x 33 mm | Stainless Steel Cap | 2 |
| 245-222 | M8 x 1.25 x 27 mm | Stainless Steel Cap | 2 | 245-238 | M12 x 1.75 x 40 mm | Stainless Steel Cap | 2 |

MASTER ASSORTMENT

No. 020-611

This assortment contains 68 Bumper Bar Bolts and 68 Self-Locking Nuts in 15 sizes selected according to popularity. Packed in a metal box with moulded plastic compartments. Descriptive lid label shows retail price codes. Will service all popular replacement needs including Metric.

For Metric Pozi-Lok® Nuts see page 36.



020-611











Size: 9-3/4" W x 13-3/4" L x 2" D.

**LICENCE PLATE BOLTS
BOULONS DE PLAQUE**

- 213**
Series
- 230**
Series
- 245**
Series
- 247**
Series

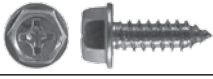
NOW - Service Stations, Garages, Dealers can turn licence plate installations into a profitable sale. Papco[®] Licence Plate Bolts are made of either heavily Electroplated Steel or UV Stabilized Nylon.

ORDER BY STOCK NUMBER Standard Package: as indicated

| Stock No. | Description | |
|-----------|--|---|
| 213-278 | No. 14 x 3/4" Indented Slotted Hex Washer Head Screw. Electro-plated to resist rust. Can be used with 247-840 Nylon Nuts. Standard package contains 100 screws. |  |
| 230-616 | M6-1.0x20mm Slotted Hex Washer Head Licence Plate Screw 13mm Washer O.D., Hex Size: 10mm, Zinc. Standard package 50 screws. |  |
| 245-900 | No. 14 x 3/4" Slotted Hex Washer Head Licence Plate Screw. 1/2" Washer O.D., Hex Size: 3/8". Standard package contains 25 screws. |  |
| 245-903 | For most compact Fords. No. 14 x 5/8" Indented Hex Slotted Oversize Washer Head Screws. Black Zinc to resist rust. Standard package 100 screws. Can be used with 247-840 Nylon Nut. |  |
| 245-906 | Universal Nylon Licence Plate nut with screws Fits all Ford, G.M. and Chrysler products having a 3/8" Square Hole. Assembly consists of a 14 x 5/8" Screw and No. 14 Square Nylon Nut. Standard package contains 50 assemblies. |  |
| 245-910 | No. 14 x 5/8" Special Truss Slot Head, Type 'B' Licence Plate Screw. Electroplated to resist rust. Standard package contains 100 screws. |  |
| 245-911 | M6-1.81x20mm Phillips Hex Washer Head Licence Plate Screw. Standard package contains 25 screws. |  |
| 245-912 | M6-1.0x16mm Slotted Round Washer Head Licence Plate Screw. Standard package contains 25 screws. |  |
| 245-914 | No. 14 x 3/4" Slotted Truss Head Licence Plate Screw. 9/16" Head Dia. Standard package contains 100 screws. |  |
| 245-915 | No. 14 x 3/4" Slotted Hex Washer Head Licence Plate Screws. Standard package 50 Screws. |  |
| 247-840 | No. 14 Licence Plate Nut. Standard package contains 25 pieces. |  |

**NYLON LICENCE PLATE BOLTS
BOULONS DE PLAQUE NYLON**

245 Series Papco[®] Nylon Licence Plate Bolts are made of stabilized Nylon. Self-locking - Can't rust - Long Lasting.

No. 245-909

Assembly consists of 1/4-20 x 1/2" Nylon Bolt and a 1/4-20 Self Locking rectangular Nut. Standard package contains 100 assemblies.



1/4-20 x 1/2

No. 245-908

Assembly consists of M6 x 20 Nylon Bolt and an M6 Nylon Hex Nut. Standard package contains 100 assemblies.



M6 x 20 mm

For **SUPER-SERVICE ASSORTMENT** No. **020-865** of Licence Plate Bolts please refer to page 11.

For **SUPER-SERVICE ASSORTMENT** No. **020-867** of Nylon Licence Plate Bolts please refer to page 11.

**MOULDING BOLTS
BOULONS DE MOULURE**

246
Series



ORDER BY STOCK NUMBER

Standard Package: 25 Pieces, * 50 Pieces

| Stock No. | OEM No. | Application |
|-----------|------------------------------------|--|
| 246-112* | 6010093, 1624705 | "Universal 'T' Bolt Clip 10-24 x 3/4" |
| 246-116* | 3792051 | "Chevrolet Front Fender 10-24 x 5/8" |
| 246-120* | 10-24 x 1/2" Universal | Universal 'T' Bolt Clip |
| 246-122* | 1758099, 6000720, 6010046, 3744999 | Universal 'T' Bolt Clip 10-24 x 1/2" |
| 246-124* | 3722635, 6013029, 6000705 | Universal 'T' Bolt Clip 10-24 x 3/4" |
| 246-210 | 4759145, 4761842, 4779348 | GM Front and Rear Fender and Door Peak - All |
| 246-212 | 3944866 | GM General Purpose |
| 246-214 | 9645350 | GM Door and Door Belt |
| 246-216 | 1484570 | GM General Purpose |
| 246-218 | 1484569, 6002356 | General Purpose Bolt Moulding |
| 246-222 | D5AB-60423B06-AA, D5DB-66423B06-CA | Ford Moulding |
| 246-226 | D5DB-66423-B06 | Ford Bolt Moulding |
| 246-228 | D8KB-5420908AA, 4003695 | Ford Moulding |

'SUPER-SERVICE' ASSORTMENT

No. 020-822

Contains 195 Moulding Bolts.
Complete coverage.
For more detail, see page 10.



**MOULDING CLIPS
PINCES DE MOULURE**

246
Series

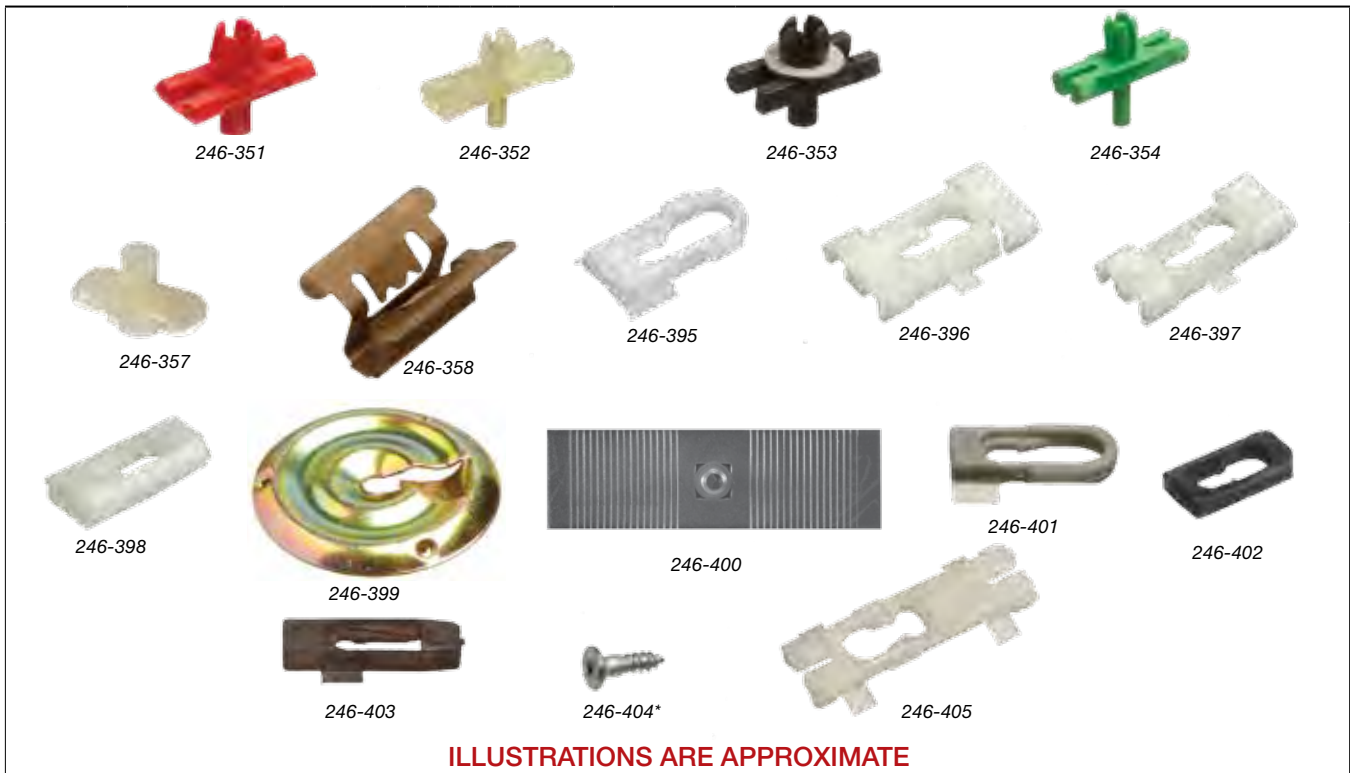

ILLUSTRATIONS ARE APPROXIMATE

ORDER BY STOCK NUMBER

Standard Package: 25 Pieces, * 100 Pieces

| Stock No. | OEM No. | Application |
|-----------|---------------------------------------|--|
| 246-351 | 803-853-139C | VW Moulding Clip Red |
| 246-352 | 825-853-139 | Audi Moulding Clip |
| 246-353 | 5113-1-804-205 | BMW Moulding Clip With Sealer |
| 246-354 | 1202-997 | Volvo Moulding Clip Green |
| 246-357 | 1-247-708 | Volvo Side Moulding |
| 246-358 | 90183-03001 | Toyota Front Bumper, Cushion Clip |
| 246-395 | 8799350 | GM Rear End and Quarter Panel Moulding |
| 246-396 | 20175051 | GM Quarter Belt Reveal Moulding |
| 246-397 | 20199675 | GM Quarter Belt Reveal Moulding |
| 246-398 | 1688094 | GM Vinyl Top Moulding |
| 246-399 | 3986976 | GM Rocker Panel Moulding - Metal |
| 246-400 | 10-24 x 3/4 Universal | Scored Type Moulding Bolt fits up to 2-1/2" wide |
| 246-401 | 9838109 | GM Body Side Moulding |
| 246-402 | 4492962 | GM Body Side and Wheel Opening Moulding |
| 246-403 | D1MY 65402488 | Ford Roof Cover and Body Side Mouldings |
| 246-404* | 4-24 x 3/8 Special Phillips Flat Head | Screw (replaces Welded Studs) |
| 246-405 | 6003133 | Chrysler Door and Fender |

**WINDOW REGULATOR RIVETS
RIVET RÉGULATEUR DE FENÊTRE**

Aluminum Body/Steel Mandrel



ORDER BY STOCK NUMBER

Standard Package: 25 Pieces

| Stock No. | OEM No. | Dia. | Flange | Grip Range | Application |
|-----------|-------------------------------|------|--------|---------------|--|
| 246-600 | 9436175, 385189-S100, 6031115 | 1/4 | 1/2 | 1/32-9/64 | GM, Ford, Chry, Window Regulator |
| 246-605 | 20184399, 389268-S100 | 1/4 | 1/2 | 11/16-3/4 | GM, Ford, Window Regulator |
| 246-610 | 385323-S100, 6031091 | 1/4 | 1/2 | 33/64"-19/32" | Ford, Chrysler, GM Window Regulator |
| 246-612 | 388047-S100 | 1/4 | 1/2 | 5/64"-7/64" | Ford Door Handle Assembly, GM Heat Shield Attach |
| 246-614 | 388442-S100 | 1/4 | 3/4 | 1/8"-1/4" | Steel Mandrel Bumper Assembly |
| 246-616 | 388047-S100 | 1/4 | 1/2 | 3/32"-1/8" | Steel Mandrel Bumper Assembly |

**GLASS SHOP FASTENERS
ATTACHES A PARE-BRISE**

**246
Series**

ORDER BY STOCK NUMBER

Standard Package: 25 Pieces, *10 Pieces



ILLUSTRATIONS ARE APPROXIMATE

| Stock No. | OEM No. | Application |
|-----------|---------------------------------|---|
| 246-356 | 1-255-553 | Volvo Windshield Moulding White |
| 246-359 | 75546-32010, 75548-32010 | Toyota Windshield Moulding with Adhesive Pad |
| 246-360* | 90674-692-0030 | Honda Windshield Moulding with Adhesive Pad |
| 246-409 | 9895598 | GM Windshield Reveal Moulding |
| 246-410 | 1654047 (Nylon) | GM Windshield and Rear Window Reveal Moulding |
| 246-411 | 8717859, 9854717 | GM Rear Window Reveal Moulding |
| 246-412 | C8AZ-63642413-A, D1AZ-6542413-B | Ford Rear Window and Windshield Moulding |
| 246-413 | 6003049, 6003752 | Chrysler Windshield and Rear Window Reveal Moulding |
| 246-415 | E3SB-6342413-AB | Ford Windshield and Backlight Moulding |
| 246-416 | 6003878 (Nylon/Metal) | Chrysler Windshield Backlight Moulding |
| 246-417 | 9662950, 9606232, 20603072 | GM Windshield and Rear Window Reveal Moulding |
| 246-418 | 9731301 (Nylon), AMC #4005540 | GM Windshield to Panel Lower Side |
| 246-419 | 20169887 (Nylon) | GM Windshield Reveal Moulding |
| 246-420 | 9808241 | GM Windshield and Rear Window Reveal Moulding |
| 246-425 | 4234830, 12337868 | GM Door Lock Rod Clip |
| 246-436 | 6003752 | Chrysler Windshield and Backlight Reveal Moulding |

**TRIM FASTENERS
ATTACHES FINITION**

**247
Series**

Christmas Tree Clips

The flexible ribs of these nylon fasteners deflect as the clip is pushed into a panel hole and hold securely anywhere along their ribbed shank. The Cut-Out-Type can be twisted into a small panel hole for retention. Used on inner door panels to hold covering or trim.

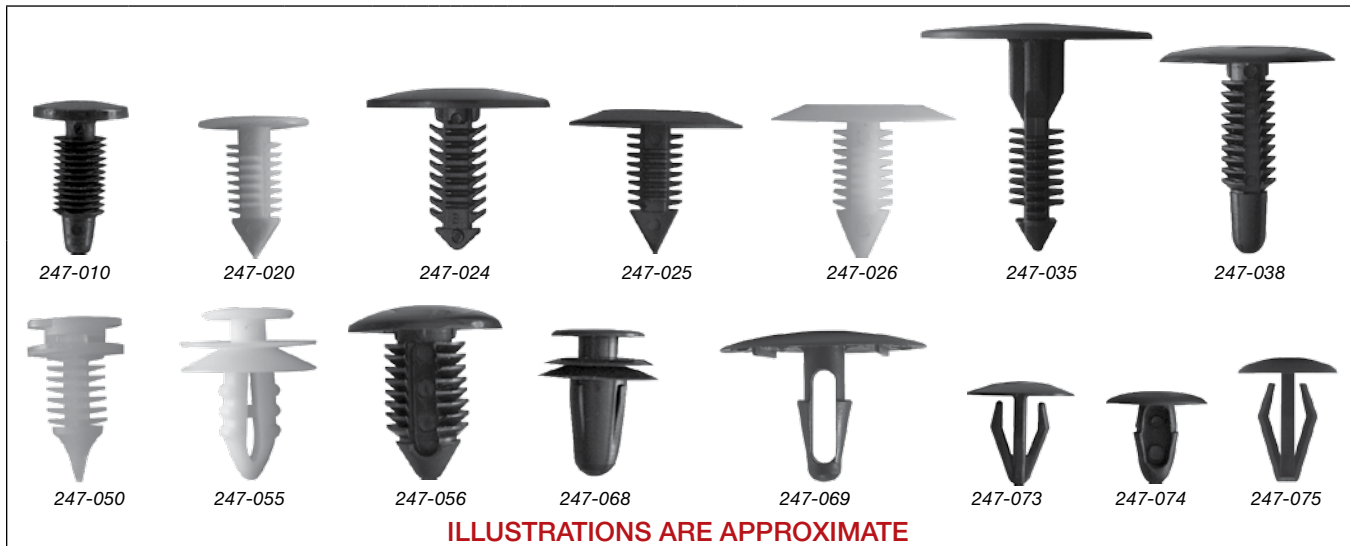

ILLUSTRATIONS ARE APPROXIMATE

ORDER BY STOCK NUMBER

Standard Package: 25 Pieces

| Stock No. | OEM No. | Application | Stock No. | OEM No. | Application |
|-----------|-------------------------------------|------------------------------------|-----------|-----------------------|------------------------------|
| 247-010 | 411700 | GM - Trim Panel Retainer | 247-055 | 387477-S | Ford - Interior Trim Panel |
| 247-020 | 6003587, 25514221 | GM, Chrysler - Roof Headliner | 247-056 | 22512276 | GM - Panel Retainer |
| 247-024 | 389443-S | Ford - Fascia To Bumper | 247-068 | 95005064, 67771-01010 | GM, Toyota - Door Trim Panel |
| 247-025 | 6003349, 6032363, 385661-S, N989022 | Ford, Chrysler - Trim Panel | 247-069 | 90467-09008 | Toyota - Retaining Clip |
| 247-026 | 6003423, 2048248 | GM, Chrysler - Interior Trim Panel | 247-073 | 38529-689A-6300 | Honda - Retaining Clip |
| 247-035 | N-800387-S | Ford - Dashboard | 247-074 | 90467-06161-01 | Toyota - Retaining Clip |
| 247-038 | 388930-S | Ford - Trim Panel Retainer | 247-075 | 76906-T3000 | Nissan - Retaining Clip |
| 247-050 | 6013122, 20298365 | GM, Chrysler - Trim Panel Ret. | | | |

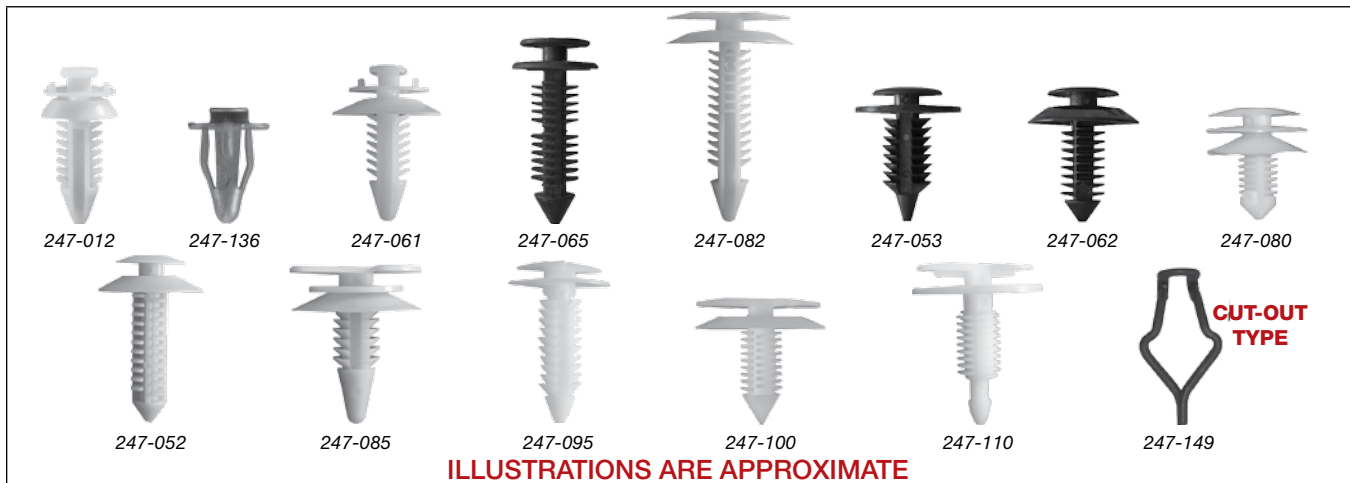

ILLUSTRATIONS ARE APPROXIMATE

ORDER BY STOCK NUMBER

Standard Package: 25 Pieces

| Stock No. | OEM No. | Application | Stock No. | OEM No. | Application |
|-----------|--|--------------------------------------|-----------|--------------------------------------|----------------------------------|
| 247-012 | 15545202, 15612948, 15607165, 15953247 | GM - Door Trim Panel | 247-082 | 10126901 | GM - Trim Panel |
| 247-052 | 8934-202-599, 10143422, N805612-S100 | Ford, GM, Jeep Eagle Door Trim Panel | 247-085 | 3065575 | GM - Door Trim Panel |
| 247-053 | N805155-S | Ford - Door Trim Panel | 247-095 | 363137 | Chev. Truck, GMC - Trim Panel |
| 247-061 | 10073833, 15600382, 20421800 | GM - Door Trim Panel | 247-100 | 9685057, N98905101, 4005470, 6003349 | GM, Chrysler, VW-Door Trim Panel |
| 247-062 | N801925-S | Ford - Door Trim Panel | 247-110 | 387496-S | Ford - Trim Panel Retainer |
| 247-065 | 387182-S | Ford - Seat Back | 247-136 | 4114785 | Chrysler - Trim Panel |
| 247-080 | 2064891, 9818648, 9883583 | GM - Door Trim Panel & Headliner | 247-149 | 383033-S101, 358470, 1900654 | Ford - Door Trim Panel |

**PLASTIC SHIELD RETAINERS
RETENUES DE PROTÉGER PLASTIQUE**

**247
Series**

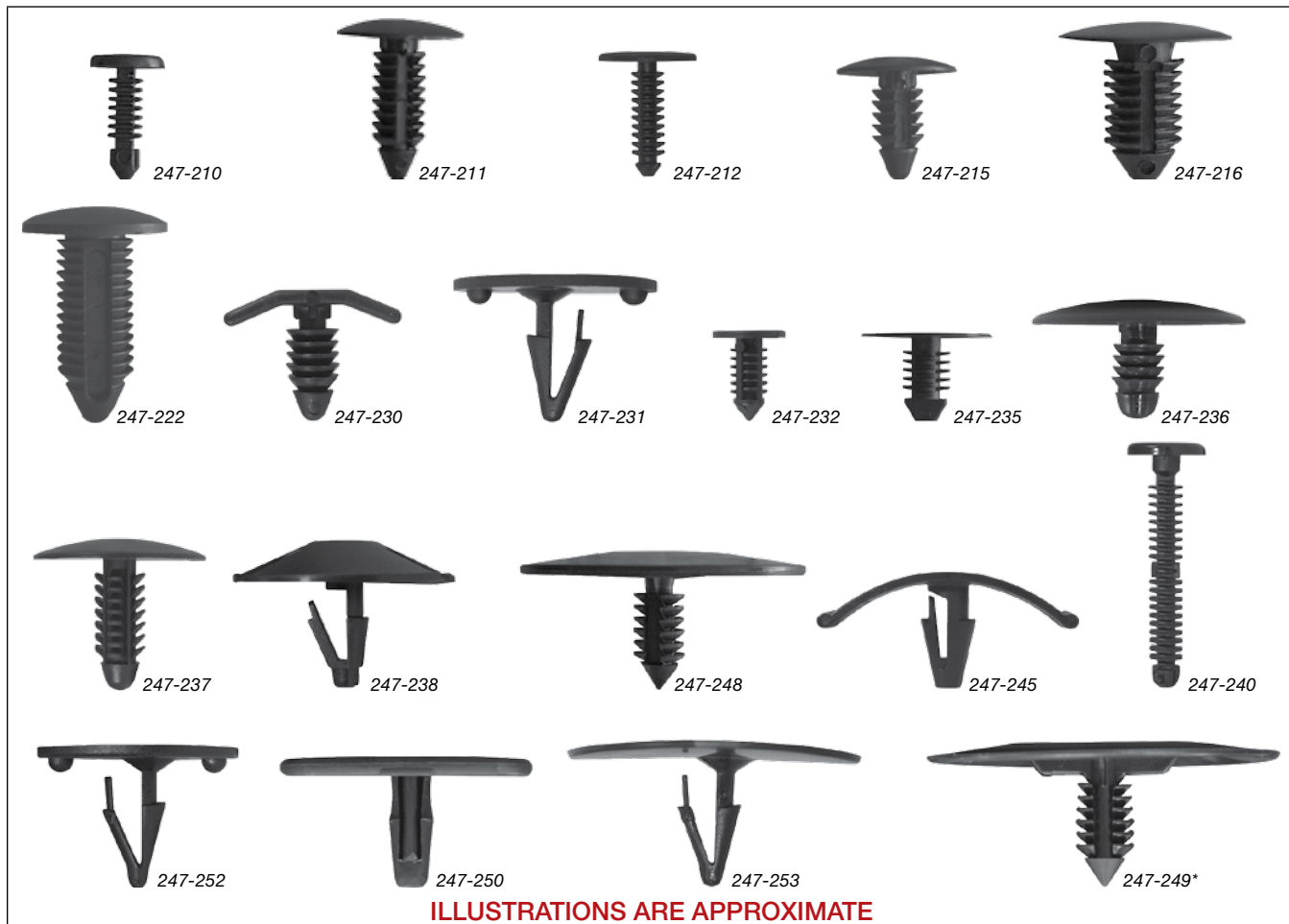

ILLUSTRATIONS ARE APPROXIMATE

ORDER BY STOCK NUMBER

Standard Package: 25 Pieces

| Stock No. | OEM No. | Application | Stock No. | OEM No. | Application |
|-----------|---|-------------------------------|-----------|---------------------------------|----------------------------|
| 247-210 | 25016383 | GM Dash Panel | 247-236 | 2998430 | Chrysler, Radiator Grille |
| 247-211 | 6030441, 388577S, 1595864, 1605396, 705589-S300 | GM, Ford, Chrysler, Radiator | 247-237 | 6501067 | Chrysler Fascia |
| 247-212 | 20514862 | GM Screen Shroud | 247-238 | 4341060 | Chrysler Hood Insulated |
| 247-215 | 4004569, 3691590, 6031321, 389358, 332364, 14093311, 20732399 | GM, Ford, Chrysler Fender | 247-240 | N-800505-S | Ford Radiator Attaching |
| 247-216 | 1619321 | GM Radiator Apron | 247-245 | 6003351, 385330-S, D30Z-16776-A | Ford Grille, Chrysler Hood |
| 247-222 | N804379S, 1631564 | GM, Ford Bumper | 247-248 | 20064875 | GM Hood Insulation |
| 247-230 | 384051-S, 480534 | GM, Ford, Cowl Insulation | 247-249 | 3977775, 3078511 | GM Hood Insulation |
| 247-231 | 385595-S, 386553-S | Ford Hood Insulation | 247-250 | 389809 | GM Hood Insulation |
| 247-232 | N803170-S | Ford Fascia | 247-252 | 386553-S | Ford Hood Insulation |
| 247-235 | 387258-S, 20032850, 3861577 | GM, Ford, Chrysler Mud Shield | 247-253 | 388908-S | Ford Hood Insulation |

TRIM PAD RELEASE TOOL

No. 247-299

Made of heat-treated, high carbon steel with bevelled front edges for easy insertion - plus a machined gripping slot for positive contact. Designed to remove plastic trim pad fasteners without damaging the fastener or backboard. Works well on metal trim pad fasteners. Individually carded.



247-299

**WEATHERSTRIP FASTENERS
ATTACHES POUR BANDE MÉTÉOROLOGIQUE**

**247
Series**

ORDER BY STOCK NUMBER

Standard Package: 25 Pieces



ILLUSTRATIONS ARE APPROXIMATE

| Stock No. | OEM No. | Application | Stock No. | OEM No. | Application |
|-----------|----------------|-----------------------------------|-----------|----------------|------------------------|
| 247-077 | 90664-671-0030 | Honda Weatherstrip Fits 5 mm Hole | 247-160 | 2964547 | Chrysler Weatherstrip |
| 247-150 | 8731909 | GM Door Weatherstrip | 247-165 | C5AB-6220586-A | Ford Door Weatherstrip |
| 247-155 | 4876498 | GM Door and Body Weatherstrip | | | |

**ANCHOR NUTS AND CLIPS
ÉCROUS ET PINCES D'ANCRAGE**

**247
Series**

ORDER BY STOCK NUMBER

Standard Package: 25 Pieces *50 Pieces **10 Pieces

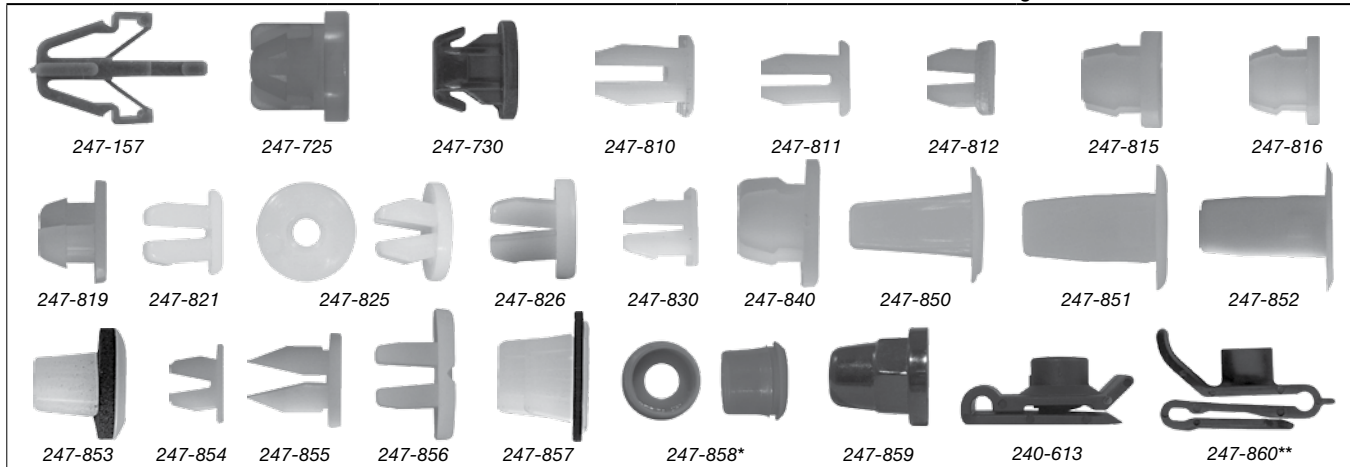

| Stock No. | OEM No. | Application | Stock No. | OEM No. | Application |
|-----------|------------------|--|-----------|--------------------------|-----------------------------------|
| 240-613 | 53879-22010 | Toyota "U" Nut No. 14 Screw | 247-851 | 90661-SC7-0030 | Honda No. 8 Screw Grommet |
| 247-157 | - | Plymouth Laser Grille Clip | | H001-50-841 | Mazda No. 8 Screw Grommet |
| | - | Ford Escort Grille Clip | | MS-480012 | Mitsubishi No. 8 Screw Grommet |
| | - | Honda Grille Clip | | 01651-00481, 74798-S9000 | Nissan No. 8 Screw Grommet |
| | 8942180270 | Isuzu Grille Clip | 247-852 | MB-098145 | Mitsubishi No. 10 Screw Grommet |
| | - | Mitsubishi & Plymouth Laser Grille Clip | | 01281-00023 | Nissan No. 10 Screw Grommet |
| 247-725 | 6031234 | Chrysler Radiator Grille Nut No. 8 Screw | | 90189-06001 | Toyota No. 10 Screw Grommet |
| 247-730 | N800503-S | Ford Grille Attachment Nut No. 6 Screw | 247-853 | 90189-04066 | Toyota No. 6 Screw Grommet |
| 247-810 | 379830-S | Ford Headlight Door No.8 or 10 Screw | | 90662-693-0030 | Honda No. 6 Screw Grommet |
| 247-811 | 1254815 | GM General Purpose No. 6 Screw | 247-854 | 90655-SA0-0030 | Honda No. 6 Screw Grommet |
| 247-812 | 9669486 | GM Side Marker No. 8 Screw | 247-855 | 90189-05013 | Toyota No. 10 Screw Grommet |
| 247-815 | 3893980 (Black) | GM Grille to Front End No. 8 Screw | | MS-480002 | Mitsubishi No. 10 Screw Grommet |
| 247-816 | 3919773 | GM Headlamp Bezel No. 8 Screw | 247-856 | 90662-671-0030 | Honda No. 10 Screw Grommet |
| 247-819 | 14013246 | GM No. 8 Screw | | 9991-00-503 | Mazda No. 10 Screw Natural Nylon |
| 247-821 | 8934-201-263 | Chrysler Radiator Grille No. 8 Screw | | 68425-H5000, | Nissan No. 10 Screw Grommet |
| 247-825 | 2524525 | Chrysler No. 8 or 10 Screw | | 62698-V7000 | |
| 247-826 | 1355003 | GM Headlight Door No. 6 or 8 Screw | 247-857 | 90668-688-0030 | Honda No.6 Screw Grommet w/sealer |
| 247-830 | 380382 | GM Headlight Bezel No. 6 or 8 Screw | 247-858* | 000-988-15-81 | Mercedes Benz Moulding Insert Red |
| 247-840 | 3907444, 4755299 | Licence Plate Nut No. 14 Screw | 247-859 | 4133-5-480-120 | BMW Plastic Nut 4mm Thread |
| 247-850 | 90672-671-8110M1 | Honda No. 6 Screw Grommet | 247-860** | 94841226 | GM "U" Nut No. 10 Screw |
| | 90189-04013 | Toyota No. 6 Screw Grommet | | 53879-14020, | Toyota "U" Nut No. 10 Screw |
| | | | | 53879-22030 | |
| | | | | 53879-14010-A | |

ANCHOR NUTS UTILITY ASSORTMENT

No. 020-358

Contains 150 Nuts of 247-810, to 247-840.
Complete coverage.

020-358



SPECIALTY RETAINERS ASSORTMENT

No. 020-450

Contains 190 pieces of the 20 most popular SKUs in specialty retainers, constructed from high-quality materials. Push-in and Screw-in types. Various diameters and lengths to fit various applications. Matching visual reference guide on the inside cover to identify parts. All items available for reorder.

020-450



ANCHOR GROMMETS AND NUTS MASTER ASSORTMENT

No. 020-678

Contains 295 Anchor Grommets and Nuts. Packed in a metal container with high-strength plastic compartments.

020-678



TRIM FASTENERS MASTER ASSORTMENT

No. 020-679

Contains 150 Fasteners – General Motors. For more details, see page 8.

020-679



TRIM FASTENERS MASTER ASSORTMENT

No. 020-680

Contains 150 Fasteners – Chrysler and Ford. For more details, see page 8.

020-680



TRIM FASTENERS 'SUPER-SERVICE' ASSORTMENT

No. 020-813

Contains 300 Trim and Weather-strip Fasteners, plus shield retainers. For more details, see page 10.

ANCHOR GROMMETS AND NUTS 'SUPER-SERVICE' ASSORTMENT

No. 020-814

Contains 465 Anchor Grommets and Nuts - 32 items. Large size, rigid metal box with high-strength plastic compartments. Size: 12" W x 18" L x 3" D. For more details see page 10.

020-814



**SCREW-IN RETAINERS
ATTACHE DE SOUTIEN AVEC VIS**

**247
Series**

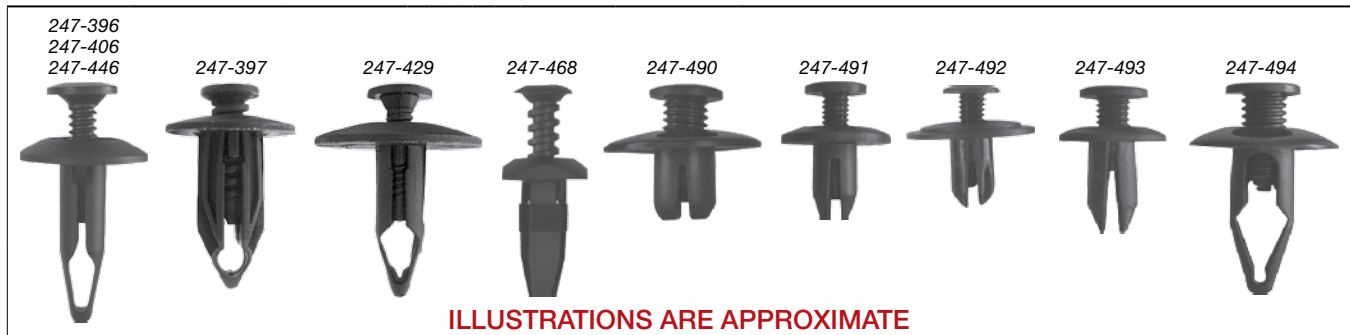

ILLUSTRATIONS ARE APPROXIMATE

ORDER BY STOCK NUMBER

Standard Package: 25 pieces

| Stock No. | OEM No. | Application | Stock No. | OEM No. | Application |
|-----------|-----------|----------------------------------|-----------|----------------|---------------------------------------|
| 247-396 | N803946-S | Ford Push-Type Exterior Retainer | 247-468 | N803494-S | Ford Aerostar Fascia, Trim and Grille |
| | 6502871 | Chrysler | | 1579091 | GM Blazer and Jimmy Door handle Bezel |
| 247-397 | 15672330 | GM Push-Type Exterior Retainer | 247-490 | 90675-SB3-003 | Honda Screw Retainer |
| | 15956470 | GM | | FB01-56-964 | Mazda |
| 247-406 | N804570-S | Ford Trim Retainer | | 63876-95596 | Nissan |
| | 20664092 | GM Exterior Body | 247-491 | 90684-SA5-0030 | Honda Screw Retainer |
| 247-429 | N804837-S | Ford Push-Type Exterior Retainer | | 10998-30880 | Nissan |
| 247-446 | N808147-S | Ford Push-Type Exterior Retainer | 247-492 | 90668-SB0-0030 | Honda Screw Retainer |
| | 10139822 | GM | 247-493 | 90467-06017-20 | Toyota Screw Retainer |
| | 25680782 | GM | 247-494 | 63844-01A00 | Nissan Screw Retainer |

PLASTIC-RIVETS

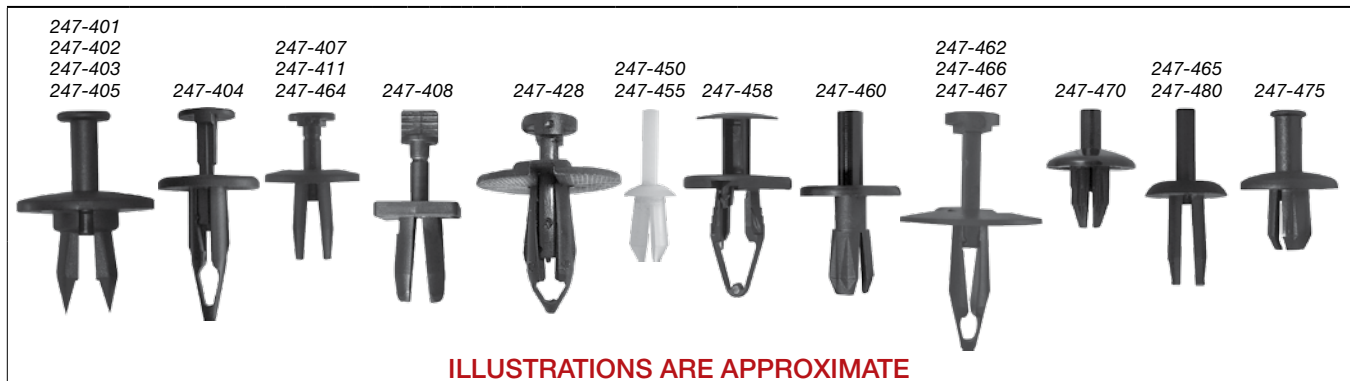

ILLUSTRATIONS ARE APPROXIMATE

ORDER BY STOCK NUMBER

Standard Package: 25 pieces, *15 pieces

| Stock No. | OEM No. | Application | Stock No. | OEM No. | Application |
|-----------|--------------|------------------------------|-----------|-----------|-----------------------------------|
| 247-401* | 5973400 | GM Fascia | 247-460 | 387944-S | Ford Grille to Metal Stamping |
| 247-402 | 5973823 | GM Fascia (Blue) | 247-462 | N802781-S | Ford Splash Shield and Fascia |
| 247-403 | 5973996 | GM Fascia (Brown) | | 14093088 | GM |
| 247-404 | 20590899 | GM Exterior Body | 247-464 | N805231-S | Ford Grille Opening Reinforcement |
| 247-405 | 14045480 | GM Fascia | 247-465 | 387843-S | Ford Fender Shield |
| 247-407 | 14019206 | GM Fender Line | 247-466 | N803362-S | Ford Body |
| 247-408 | 14032200 | GM Grille Attachment | | 20510029 | GM |
| 247-411 | 14019226 | GM Rad Overflow and | 247-467 | 6501590 | Chrysler Splash Shield and Fascia |
| | 14071289 | Windshield washer Reservoir | | N803421-S | Ford |
| 247-428 | 20547865 | GM Exterior Body Retainer | 247-470 | 383142-S | Ford Grille to Headlamp Bracket |
| 247-450 | 14005089 | GM A/C Vents General Purpose | 247-475 | 6031383 | Chrysler Grille |
| 247-455 | 10017619 | GM Front Bumper Grille bar | 247-480 | 6031390 | Chrysler Plastic Inner Fender |
| 247-458 | W712665-S300 | Ford Exterior Body Retainer | | | |
| | 11589295 | GM | | | |

**UTILITY SCISSORS
CISEAUX FONCTIONNELS**

249
Series

No. 249-120

Professional quality features stainless steel blades with long-lasting ground edges and high-impact, man-size A.B.S. plastic handles. Individually packaged on 'try-me' blister card.



**UTILITY SHEARS
CISAILLES FONCTIONNELS**

No. 249-130

Professional quality, stainless steel blades with long-lasting edges. High-impact handles with safety lock. For wire, thin sheet metal, shim stock, vinyl, fiberglass and more. Individually carded.



**UTILITY SCRAPERS
GRATTOIRS FONCTIONNELS**

Papco[®] Utility Scrapers are ideal for trimming, cutting, splicing, scraping paint or stickers. Choose from the retractable, pocket size or standard, angled head for hard-to-reach places - both use either steel or plastic razor blades.

No. 249-124 Angled Head for hard-to-reach places

No. 249-125 Retractable, pocket size

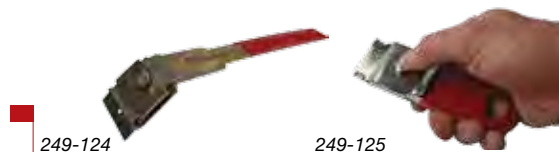

**REPLACEMENT BLADES
LAMES DE RECHANGE**

Steel Razor Blades

No. 249-126

Single edge, industrial duty steel replacement blades for No. 249-124 and 249-125 utility scrapers. Skin packed card contains 10 blades in a recloseable box.



Plastic Razor Blades

No. 249-127

For cleaning sun film or laminated glass without cutting or nicking. Fits both Papco[®] Utility Scrapers. Skin packed card contains 100 blades in a recloseable box.



**TOOLS
OUTILS**

246
Series

Windshield Moulding Release Tool

No. 246-500

Windshield Moulding Release Tool for removing all windshield mouldings. Features angled shaft and bevelled front edges for easy entry.



Window Handle Removing Tool

No. 246-895

Window Handle Removing Tool for removing inside door and window handles.



**PLUG BUTTONS
BOUCHONS**





**314
Series**

Black Vinyl or Metal

Papco[®] Plug Buttons are used for plugging unsightly body holes after removing accessories, rust-proofing or body repair.

ORDER BY STOCK NUMBER

Standard Package: 100 Pieces

| Stock No. | Description | |
|-------------|--|---|
| Black Vinyl | | |
| 314-314 | 3/8 Diameter, Flush Sheet Metal Plug Head Dia. 3/4" |  |
| 314-316 | 1/2 Diameter, Flush Sheet Metal Plug Head Dia. 7/8" |  |
| Black Vinyl | | |
| 314-322 | 1/2 Diameter, Plastic Plug Button Head Dia. 7/8" |  |
| 314-326 | 3/4 Diameter, Plastic Plug Button Head Dia. 1-5/32" |  |
| 314-328 | 7/8 Diameter, Plastic Plug Button Head Dia. 1-7/32" |  |
| 314-330 | 1" Diameter, Plastic Plug Button Head Dia. 1-11/32" |  |

**CASTER AND CAMBER SHIMS
CALES POUR CHASSE DIRECTION**

**250
Series**

Papco[®] Shims are used to adjust caster on knee-action and ball-joint suspensions.

All Papco[®] shims are plated to resist rust and stamped with thickness or degree.

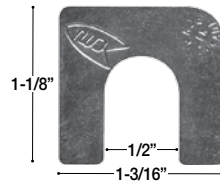

| General Motors 1971-up | | |
|------------------------|-----------|------|
| Stock No. | Thickness | Slot |
| 250-082 | 1/6" | 1/2" |
| 250-083 | 1/8" | 1/2" |

1-3/16"W x 1-1/8" H.

**BODY SHIMS
CALES DE CARROSSERIE**

**250
Series**

- Used for alignment of Hoods, Fenders, Cowls and Starter Motors
- Plated Steel, Standard Package Contains 25 Shims

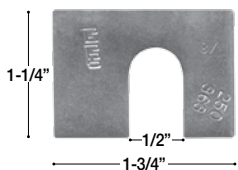

| Body Shim | |
|-----------|-----------|
| Stock No. | Thickness |
| 250-362 | 1/16" |
| 250-363 | 1/8" |

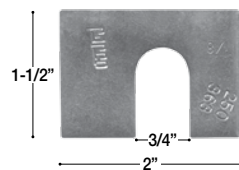

| Body Shim | |
|-----------|-----------|
| Stock No. | Thickness |
| 250-368 | 1/8" |

Ford

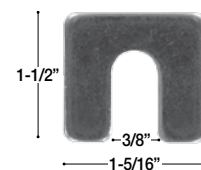

| Hood Shim | |
|-----------|-----------|
| Stock No. | Thickness |
| 250-371 | 1/16" |
| 250-372 | 1/8" |

Chevrolet

DOOR HINGE PINS AND BUSHINGS GOUPILLES ET BAGUES DE CHARNIÈRE – PORTES

Papco® Door Hinge Pins and Bushings are replacements for original equipment hardware that has worn, been broken or damaged - causing misalignment, sagging or sticking.

ILLUSTRATIONS ARE APPROXIMATE



250-545 Std. Pkg. 25 pcs.
O.D. 1/2", I.D. 11/32"
 • GM C-K Models 1988-on
 Height: 23/64", Flange O.D. 43/64"
 Splined O.D. Side Door Upper Hinge
Door Hinge Bushing
 #12338074, 15691493, 15964971, 16632193
 CL Part No: 910-1615, Pieces: 2



250-546 Std. Pkg. 25 pcs.
O.D. 17/32", I.D. 25/64"
 • GM C-K Models 1988-on
 Height: 23/64", Flange O.D. 11/16"
 Splined O.D. Side Door Lower Hinge
Door Hinge Bushing
 #15562609, 15964972, 16632192
 CL Part No: 910-1616, Pieces: 2



250-549 Std. Pkg. 25 pcs.
O.D. 1/2", I.D. 11/32"
 • Buick 1976-on • Cadillac 1980-on
 • Chevrolet All 1976-on, Corvette 1982-73
 • Olds Exc. Starfire: 1980-on
 • Pontiac Exc. Astre & Sunbird 1980-on
 Height: 3/8", Flange O.D. 19/32"
Door Hinge Bushing
 #9716926, 20345137
 CL Part No: 910-1600, Pieces: 3



250-550 Std. Pkg. 25 pcs.
O.D. 27/64", I.D. 11/32"
 • Buick (Exc. Skyhawk) 1967-on • Cadillac 1946-on
 • Chevrolet (Exc. Monza & Vega) 1962-on, Corvette 1956-on
 • GM C&K Truck 1993-79 • Olds (Exc. Starfire) 1949-on
 • Pontiac (Exc. Astre & Sunbird) 1932-on
 Height: 19/64", Flange O.D. 19/32"
Door Hinge Bushing
 GM #9721917, FORD #D1AZ-6522841A
 CL Part No: 910-1601, Pieces: 2



250-551 Std. Pkg. 25 pcs.
O.D. 31/64", I.D. 11/32"
 • Ford 1973-on
 Head Dia. 20mm, Stem Length: 9mm
 Flange O.D. 19/32
Door Hinge Bushing
 #D90Z-6522841A
 CL Part No: 910-1602, Pieces: 2



250-552 Std. Pkg. 25 pcs.
O.D. 5/16", I.D. 17/64"
 • Dodge & Chrysler 1970-on
 Length: 23/64", Flange O.D. 33/64"
Door Hinge Bushing
 #4033711
 CL Part No: 910-1603, Pieces: 3

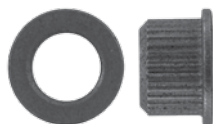

250-553 Std. Pkg. 25 pcs.
O.D. 31/64", I.D. 11/32"
 • GM (Including Pick-Ups & Vans) 1968-on
 Length: 23/64", Flange O.D. 19/32"
 Splined O.D.
Door Hinge Bushing
 #20429500
 CL Part No: 910-1610, Pieces: 2



250-559
Pin Dia. 11/32", Length: 4-1/16"
 • Buick, Cadillac, Chevrolet, Oldsmobile, Pontiac 1992-1973
 Overall Head Dia. 9/16"
Door Hinge Pin
 #6271989, 20046147
 CL Part No: 910-1620, Pieces: 1



250-560
Pin Dia. 11/32", Length: 4"
 • Buick, Chevrolet, Oldsmobile, Pontiac 1995-1978
 Overall Head Dia. 7/16"
Door Hinge Pin
 #20043351
 CL Part No: 910-1625, Pieces: 1

**DOOR HINGE PINS AND BUSHINGS
GOUPILLES ET BAGUES DE CHARNIÈRE – PORTES**

ILLUSTRATIONS ARE APPROXIMATE



250-561

Dia. 11/32", Length: 5-1/4"

• **GM C & K Trucks 1988-2000**
Shoulder O.D. 3/8", Head O.D. 9/16"
Stainless Steel Door Hinge Pin
#15591860; 15691595; 15967691; 88891731
CL Part No: 910-1630, Pieces: 1



250-562

Pin Dia. 17/64", Length: 2-3/4"

• **Dodge & Plymouth** vans, Ramcharger & Trailduster 1970-on
Head O. D. 9/16"
Door Hinge Pin
Cargo doors, lift gates, rear doors and fold-up rear seat floor hinges
#6028993, 6032975



250-563

Dia. 9/16", Length: 5-1/2"

• **GM C & K Trucks 1988-2000**
Knurl Dia. 19/32", Roller Overall Dia. 3/4",
Door Roller Pin Assembly
Roller Groove Dia. 5/8"
Not Available through O.E.M.



250-564

Dia. 25/64", Length: 5-1/16"

• **GM S & T Trucks 1994-on**
Door Roller Pin Assembly
Roller Overall Dia. 3/4",
Roller Groove Dia. 5/8"
#15672183

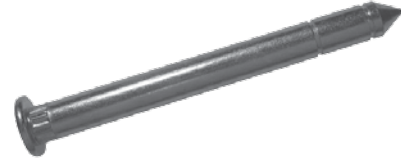

250-566

Dia. 11/32", Length: 3-1/2"

• **Ranger F150, F250, F350 1998-80**
Knurl Dia. .358", Overall Head Dia. 9/16"
Door Hinge Pin



250-567

Door Hinge Repair Kit

• **Chevrolet** Suburban 1500/2500 & Tahoe 2006-2000 • **GMC** Yukon 2006-2001
• **Cadillac** Escalade 2006-2000
• **Chevrolet** Silverado & **GMC** Sierra 1500/2500, HD/3500, HD 2007-1999
Door Hinge Repair Kit
#89025539

BLIND RIVETS RIVETS OBTURATEURS

239
Series



Fasten joints without access to reverse side. Insert rivets - the retracting jaws in the setting tool pull the mandrel head into the rivet body on the reverse side until the mandrel breaks. The high clinch action pulls the parts together for a tight, vibration-proof fastening.

Standard Package: 1/8" and 5/32" Dia. 500 rivets; 3/16" Dia. 250 rivets; Stainless Steel 100 rivets. Most popular sizes available in 50 Rivets per convenient hang-up boxes. *25 per hang-up box.

| Rivet Diameter | | Drill | | How to measure rivets: | |
|----------------|--------|--------|-------------|------------------------|--|
| Inch | Metric | Number | Size | | |
| 3/32 | 2.4 mm | No. 41 | .096 - .100 | | |
| 1/8 | 3.2 mm | No. 30 | .129 - .133 | | |
| 5/32 | 4.0 mm | No. 20 | .160 - .164 | | |
| 3/16 | 4.8 mm | No. 11 | .192 - .196 | | |

ORDER BY STOCK NUMBER

| Stock No. | Other No. | Hang-up Box No. | Rivet Dia. | Grip Range | Head Type | Rivet Length | |
|--|-----------|-----------------|--|--|--------------|--------------|------|
| Aluminum Rivet - Aluminum Mandrel | | | | | | | |
| 239-011 | AA42D | 239-611 | 1/8 (.125) ↓ 5/32 (.156) ↓ 3/16 (.188) ↓ 3/16 (.188) ↓ 3/16 (.188) ↓ 3/16 (.188) ↓ 3/16 (.188) ↓ 3/16 (.188) ↓ 3/16 (.188) | 1/16 - 1/8 | Domed Head | .232 | |
| 239-014 | AA43D | 239-614 | | 1/8 - 3/16 | Domed Head | .294 | |
| 239-017 | AA44D | 239-617 | | 3/16 - 1/4 | Domed Head | .357 | |
| 239-018 | AA44LF | - | | 3/16 - 1/4 | Large Flange | .357 | |
| 239-023 | AA46D | - | | 5/16 - 3/8 | Domed Head | .481 | |
| 239-026 | AA48D | - | | 3/8 - 1/2 | Domed Head | .625 | |
| 239-038 | AA56D | - | | 1/4 - 3/8 | Domed Head | .504 | |
| 239-047 | AA62D | 239-647* | | 1/16 - 1/8 | Domed Head | .277 | |
| 239-053 | AA64D | 239-653* | | 1/8 - 1/4 | Domed Head | .402 | |
| 239-056 | AA66D | - | | 1/4 - 3/8 | Domed Head | .527 | |
| 239-057 | AA66LF | - | | 1/4 - 3/8 | Large Flange | .527 | |
| 239-059 | AA68D | - | | 3/8 - 1/2 | Domed Head | .652 | |
| 239-060 | AA68LF | - | | 3/8 - 1/2 | Large Flange | .652 | |
| Aluminum Rivet - Steel Mandrel | | | | | | | |
| 239-111 | AS42D | 239-711 | 1/8 (.125) ↓ 3/16 (.188) ↓ 3/16 (.188) ↓ 3/16 (.188) ↓ 3/16 (.188) ↓ 3/16 (.188) | 1/16 - 1/8 | Domed Head | .232 | |
| 239-114 | AS43D | 239-714 | | 1/8 - 3/16 | Domed Head | .294 | |
| 239-117 | AS44D | 239-717 | | 3/16 - 1/4 | Domed Head | .357 | |
| 239-150 | AS62D | 239-750* | | 1/16 - 1/8 | Domed Head | .277 | |
| 239-153 | AS64D | 239-753* | | 1/8 - 1/4 | Domed Head | .402 | |
| 239-156 | AS66D | - | | 1/4 - 3/8 | Domed Head | .527 | |
| 239-159 | AS68D | - | | 3/8 - 1/2 | Domed Head | .652 | |
| 239-160 | AS68LF | - | | 3/8 - 1/2 | Large Flange | .652 | |
| Steel Rivet - Steel Mandrel | | | | | | | |
| 239-210 | SS42C | 239-810 | | 1/8 (.125) ↓ 5/32 (.156) ↓ 3/16 (.188) ↓ 3/16 (.188) ↓ 3/16 (.188) ↓ 3/16 (.188) ↓ 3/16 (.188) ↓ 3/16 (.188) ↓ 3/16 (.188) ↓ 3/16 (.188) ↓ 3/16 (.188) ↓ 3/16 (.188) ↓ 3/16 (.188) ↓ 3/16 (.188) | 1/16 - 1/8 | Countersunk | .276 |
| 239-211 | SS42D | 239-811 | 1/16 - 1/8 | | Domed Head | .232 | |
| 239-213 | SS43C | 239-813 | 1/8 - 3/16 | | Countersunk | .316 | |
| 239-214 | SS43D | 239-814 | 1/8 - 3/16 | | Domed Head | .294 | |
| 239-216 | SS44C | 239-816 | 3/16 - 1/4 | | Countersunk | .362 | |
| 239-217 | SS44D | 239-817 | 3/16 - 1/4 | | Domed Head | .357 | |
| 239-218 | SS44LF | - | 3/16 - 1/4 | | Large Flange | .357 | |
| 239-223 | SS46D | - | 5/16 - 3/8 | | Domed Head | .481 | |
| 239-226 | SS48D | - | 3/8 - 1/2 | | Domed Head | .625 | |
| 239-229 | SS52D | - | 1/16 - 1/8 | | Domed Head | .254 | |
| 239-235 | SS54D | - | 3/16 - 1/4 | | Domed Head | .397 | |
| 239-238 | SS56D | - | 1/4 - 3/8 | | Domed Head | .504 | |
| 239-250 | SS62D | 239-850* | 1/16 - 1/8 | | Domed Head | .277 | |
| 239-253 | SS64D | 239-853* | 1/8 - 1/4 | | Domed Head | .402 | |
| 239-256 | SS66D | - | 1/4 - 3/8 | | Domed Head | .527 | |
| 239-257 | SS66LF | - | 1/4 - 3/8 | | Large Flange | .527 | |
| 239-259 | SS68D | - | 3/8 - 1/2 | | Domed Head | .652 | |
| 239-260 | SS68LF | - | 3/8 - 1/2 | | Large Flange | .652 | |
| 239-262 | SS610D | - | 1/2 - 5/8 | | Domed Head | .777 | |
| 239-263 | SS610LF | - | 1/2 - 5/8 | | Large Flange | .777 | |
| 239-265 | SS612D | - | 5/8 - 3/4 | | Domed Head | .902 | |
| 239-266 | SS612LF | - | 5/8 - 3/4 | | Large Flange | .902 | |
| Stainless Rivet - Steel Mandrel | | | | | | | |
| 5195-111 | STS42D | - | 1/8 (.125) ↓ 3/16 (.188) ↓ 3/16 (.188) ↓ 3/16 (.188) ↓ 3/16 (.188) ↓ 3/16 (.188) | | 1/16 - 1/8 | Domed Head | .232 |
| 5195-114 | STS43D | - | | | 1/8 - 3/16 | Domed Head | .294 |
| 5195-117 | STS44D | - | | | 3/16 - 1/4 | Domed Head | .357 |
| 5195-123 | STS46D | - | | 5/16 - 3/8 | Domed Head | .481 | |
| 5195-126 | STS48D | - | | 3/8 - 1/2 | Domed Head | .625 | |
| 5195-150 | STS62D | - | | 1/16 - 1/8 | Domed Head | .277 | |
| 5195-153 | STS64D | - | | 1/8 - 1/4 | Domed Head | .402 | |
| 5195-156 | STS66D | - | | 1/4 - 3/8 | Domed Head | .527 | |
| 5195-159 | STS68D | - | | 3/8 - 1/2 | Domed Head | .652 | |
| Stainless Rivet - Stainless Mandrel | | | | | | | |
| 5195-211 | STST42D | - | 1/8 (.125) ↓ 3/16 (.188) ↓ 3/16 (.188) ↓ 3/16 (.188) ↓ 3/16 (.188) ↓ 3/16 (.188) | 1/16 - 1/8 | Domed Head | .232 | |
| 5195-214 | STST43D | - | | 1/8 - 3/16 | Domed Head | .294 | |
| 5195-217 | STST44D | - | | 3/16 - 1/4 | Domed Head | .357 | |
| 5195-223 | STST46D | - | | 5/16 - 3/8 | Domed Head | .481 | |
| 5195-226 | STST48D | - | | 3/8 - 1/2 | Domed Head | .625 | |
| 5195-250 | STST62D | - | | 1/16 - 1/8 | Domed Head | .277 | |
| 5195-253 | STST64D | - | | 1/8 - 1/4 | Domed Head | .402 | |
| 5195-256 | STST66D | - | | 1/4 - 3/8 | Domed Head | .527 | |
| 5195-259 | STST68D | - | | 3/8 - 1/2 | Domed Head | .652 | |

**HAND RIVETERS
RIVETEUSE MANUELLE**

239
Series

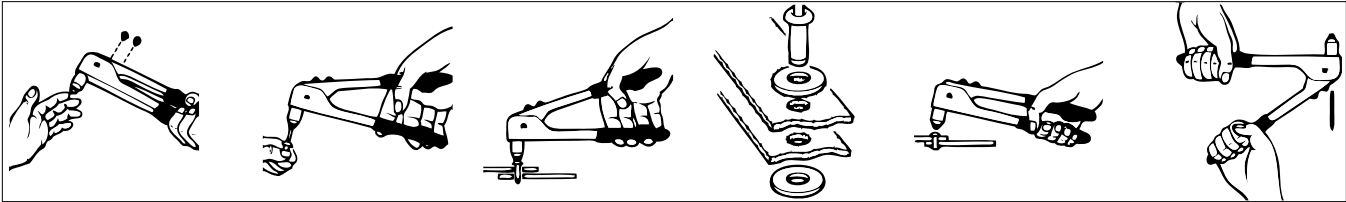

1. Drill a hole of the recommended size in each of the parts to be riveted and select correct nose-piece.
2. Fully open handles. Insert rivet until head touches nose-piece.
3. Insert rivet in the hole.
4. For soft materials or oversize holes use back-up plates to eliminate rivet pull-through.
5. Squeeze handles together. If mandrel does not break, open handles, push rivet head back to nose-piece and repeat until mandrel breaks.
6. Hold riveter with nose-piece up. Fully open handles and snapped off stem will fall out.

MEDIUM DUTY BLIND RIVETER

No. 239-500

An economical tool for medium duty. Vinyl grips on stamped long handles for extra leverage with milled steel nose. Sets 3/32", 1/8", 5/32" and 3/16" Dia. aluminum rivets. Individually packaged.



239-500

PROFESSIONAL SERVICE BLIND RIVETER

No. 239-501

Sturdy, fast acting tool. Will set 3/32", 1/8", 5/32" and 3/16" Dia. rivets. Capacity 3/16" aluminum. Moulded contour hand grips and long forged handles for extra leverage. Complete with four nose-pieces. Heavy Duty Individually packaged.



239-501

BLIND RIVET MASTER ASSORTMENT

No. 020-667

Contains 1200 pieces - 10 popular sizes of Aluminum and Steel Domed Head Rivets and 3 sizes of Back-up Plates. Packed in a sturdy metal container with handy moulded compartments and an actual size illustrated grease-resistant lid label. Size: 9-3/4" W x 13-3/4" L x 2" D.



020-667

**MULTI-GRIP BLIND RIVETS
RIVETS OBTURATEURS MULTI-GRIP**

239
Series

These blind rivets cover the grip range of three standard rivets. Excellent where a combination of hard and soft materials needs fastening. Compensates for hole size and alignment variations. Aluminum body and steel mandrel. Domed head.

ORDER BY STOCK NUMBER

Standard Package: 100 Rivets.

| Stock No. | Other No. | Rivet Dia. | Grip Range | Rivet Length |
|-----------|-----------|-------------|------------|--------------|
| 239-314 | AD41-43 | 1/8 (.125) | .031-.185 | .315 |
| 239-320 | AD43-45 | 1/8 (.125) | .157-.335 | .480 |
| 239-335 | AD52-54 | 5/32 (.156) | .047-.248 | .425 |
| 239-353 | AD62-64 | 3/16 (.187) | .063-.252 | .414 |

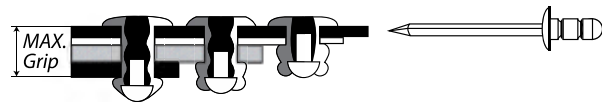

**BACK-UP PLATES
PLAQUES DE RENFORT**

239
Series

- 239-493 Back-up plates for 1/8" Dia. Rivets (9/64 x 3/8 x 1/32) Plated Steel, 100 per box.
- 239-494 Back-up plates for 3/16" Dia. Rivets (13/64 x 1/2 x 3/64) Plated Steel, 100 per box.
- 239-492 Back-up plates for 3/16" Dia. Rivets (13/64 x 1/2 x 3/64) Aluminum, 100 per box.



239-493

**PLASTIC RIVETS
RIVETS EN PLASTIQUE**

247
Series

Papco[®] Plastic Expansion Rivets are used to fasten panels, fascia strips, inner fenders, grilles, shields etc. Moulded of nylon, the three leg design draws panels tightly together as the mandrel breaks off.

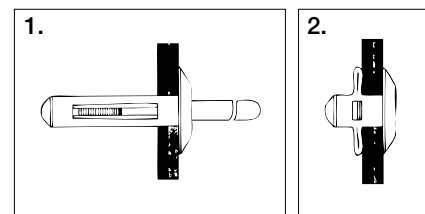

ORDER BY STOCK NUMBER

Standard Package: 25 Pieces

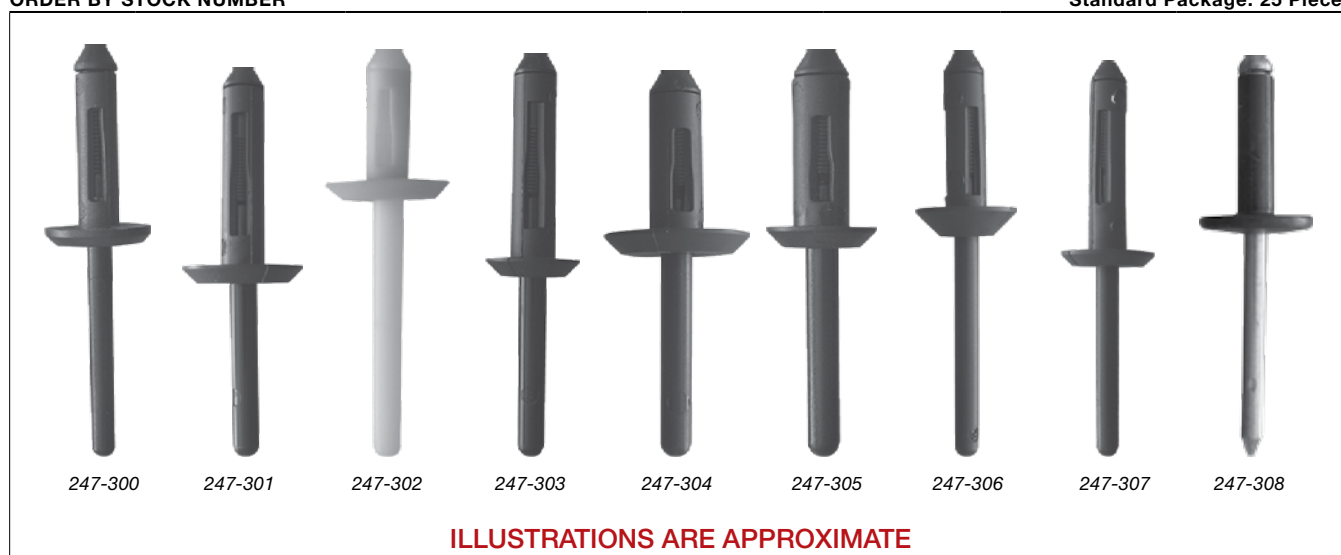

ILLUSTRATIONS ARE APPROXIMATE

| Stock No. | OEM No. | Rivet Dia. | Max . Grip | Head Flange Dia. | Drill Size |
|-----------|--|------------|------------|------------------|------------|
| 247-300 | Chrysler: 6500899, GM: 20432975 VW: 175-853-57701C | 5 mm | 6 mm | 12 mm | 7/32 |
| 247-301 | Chrysler: 6500911 Ford: N803043-S GM: 14063981 | 6.3 | 10 | 17 | 1/4 |
| 247-302 | GM: 14070914 (White) | 6.3 | 6 | 17 | 1/4 |
| 247-303 | Ford: N803862-S GM: 20452072 | 6.3 | 10 | 13 | |
| 247-304 | GM: 20433026 VW: 175-853-577A | 6.6 | 5 | 17 | 9/32 |
| 247-305 | GM: 20421672 | 6.6 | 5 | 13 | 9/32 |
| 247-306 | Ford: N804189S, GM: 2042367 | 5 | 4.5 | 12 | 7/32 |
| 247-307 | Chrysler: 6500898 | 5 | 10 | 12 | 7/32 |
| 247-308 | 388664-S100 (Black) Ford Fascia & Bumper (Aluminum) | 3/16" | 1/2" | 9/16" | — |

For Papco[®] Plastic Rivets Master Assortment No. 020-693 see page 8.

PLASTIC RIVET SETTING TOOL

No. 247-330

This sturdy steel tool sets all sizes of plastic rivets. The long reach gets into tight areas and the extra leverage allows fast, one-stroke setting. Used with Plastic Rivets above. Order by stock number. Individually packaged.



247-330

**BLIND WELL NUTS
ÉCROUS PUIITS OBTURATEURS**

**239
Series**

Consists of a flanged neoprene bushing with a captive brass insert nut. As the screw is tightened the bushing expands making a secure fastening in thin sheet metal or blind holes. Use to mount accessories on cars, vans, trucks, snowmobiles, fibreglass boats etc.

ORDER BY STOCK NUMBER

Standard Package: 10 Nuts

| Stock No. | Thread Size | Hole Size | Panel Thick. Max. | Flange Dia. | Shank Length |
|-----------|-------------|-----------|-------------------|-------------|--------------|
| 239-974 | 6-32 | 5/16 | .156 | .462 | .437 |
| 239-976 | 8-32 | 5/16 | .156 | .438 | .447 |
| 239-985 | 10-32 | 3/8 | .227 | .750 | .620 |
| 239-991 | 1/4-20 | 1/2 | .187 | .625 | .642 |

BLIND WELL NUT GARAGE ASSORTMENT

No. 020-081

Contains 20 nuts in 6-32, 8-32, 10-32, and 1/4-20. Packed in a clear plastic box.

020-081



MIRROR MOUNTING 'JACK' NUT

No. 239-960

Made of 1010 Zinc Plated Steel this 1/4-20 Jack Nut with sealer has been designed for mounting outside mirrors to body panels. Legs of nut expand as screw is driven providing a positive, water-tight connection. Used with Papco® Body Bolt No. 245-610 on page 142. May also be used to attach licence plates. Standard package 25 Pieces.

239-960



**'SERT-A-NUTS'
ÉCROUS D'ANCRAGE**

**222
Series**

Papco® Aluminum 'Sert-a-Nuts' may be used in sheet metal, plastic, castings, fibreglass, or any rigid material. 'Sert-a-Nut' has an unlimited grip range and no thickness barrier. Eliminates the need for tapping, welding or brazing. Kits include Setting Tool, Socket Screw and Hex Key.

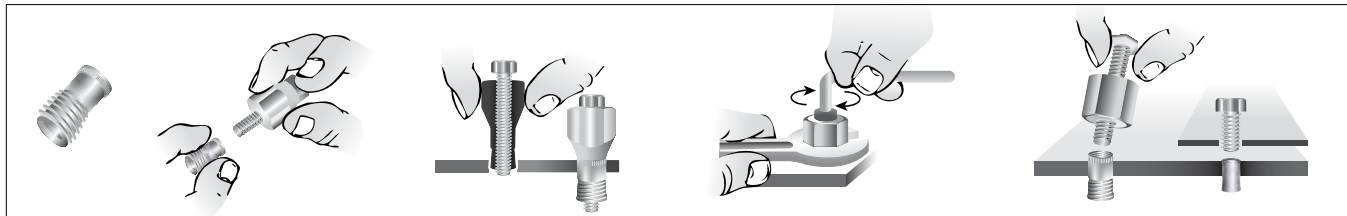

1. Place screw through tool and thread into 'Sert-a-Nut' flange side up.
2. Insert 'Sert-a-Nut' into pre-drilled hole.
3. Hold tool with wrench, turn screw with key until tight.
4. 'Sert-a-Nut' is now anchored solidly into hole.

ORDER BY STOCK NUMBER

| Stock No. | Size | Drill | Standard Package | Stock No. | Size | Drill | Inserts Per Kit |
|----------------------|--------|-------|------------------|--------------------------|--------|-------|-----------------|
| 'SERT-A-NUTS' | | | | 'SERT-A-NUT' KITS | | | |
| 222-304 | 6-32 | 7/32 | 25 | 222-314 | 6-32 | 7/32 | 5 |
| 222-306 | 8-32 | 1/4 | 25 | 222-316 | 8-32 | 1/4 | 5 |
| 222-308 | 10-24 | 9/32 | 25 | 222-318 | 10-24 | 9/32 | 5 |
| 222-310 | 1/4-20 | 3/8 | 25 | 222-320 | 1/4-20 | 3/8 | 5 |

'SERT-A-NUT' GARAGE ASSORTMENT

No. 020-090

Contains 4 complete kits for 6-32, 8-32, 10-24 and 1/4-20 'Sert-a-Nuts'. Four sizes in a clear plastic box.

020-090



AN INTRODUCTION TO...

EXPANSION PLUGS

BOUCHONS D'EXPANSION

...UNE INTRODUCTION.

www.hpaulin.com

For a full listing of Papco® Expansion Plugs and application guide, please refer to our current catalogue or visit our website to download a PDF version.



EXPANSION PLUG KITS

- BRASS
- STEEL

EXPANSION PLUGS (IMPERIAL AND METRIC)

- CUP TYPE
- SHALLOW CUP TYPE
- STANDARD CUP TYPE

'E-Z SEAL' EXPANSION PLUGS



**EXPANSION PLUG KITS
TROUSSES DE BOUCHONS D'EXPANSION**

**260
Series**

- **DOMESTIC - IMPORT - TRUCKS - MARINE**
A time-saving kit for machine shops, engine rebuilders and Jobbers. Expansion plugs for each engine skin-packed in one convenient package. Coverage for Domestic and Import engines.



BRASS / MARINE

| Year | Cyl. | Application | Kit No. |
|-------------------------|------|-----------------|---------|
| GM, MERCURY, OMC | | | |
| All | (V8) | 4.6L (283 C.I.) | 260-488 |
| All | (V8) | 5.0L (305 C.I.) | 260-488 |

STEEL

| Year | Cyl. | Application | Kit No. |
|------------|------|-------------|---------|
| AMC | | | |
| 1997-87 | (V6) | 4.0L (244) | 260-401 |
| 1988-71 | (V6) | 4.2L (258) | 260-402 |

| BUICK | | | |
|--------------|------|--|---------|
| 1992-80 | (4) | 2.5L (151) | 260-400 |
| 1989-80 | (V6) | 2.8L (173) W, X, Y, Z | 260-407 |
| 2010-85 | (V6) | 3.0L (181) E, L 3.8L (231) A, B, G, 2, 3, 7, 8, 9 | 260-406 |
| 1992-77 | (V8) | 5.0L (305) | 260-425 |
| 1990-80 | (V8) | 4.3L (260) Diesel; 5.0L (307) Y 5.7L (350) N Diesel | 260-413 |

| CADILLAC | | | |
|-----------------|------|-------------------------------------|---------|
| 1992-88 | (V6) | 4.5L (273) | 260-415 |
| 1993-86 | (V8) | 5.0L (307) Y 5.7L (350) N Diesel | 260-413 |

| CHEVROLET | | | |
|------------------|------|---|---------|
| 2002-90 | (4) | 2.2L (134) | 260-425 |
| 1992-78 | (4) | 2.5L (151) | 260-400 |
| 1989-80 | (V6) | 2.8L (173) W, X, Z, I | 260-407 |
| 2005-88 | (V6) | 3.8L (231) I, K, L | 260-410 |
| 1990-85 | (V6) | 4.3L (262) | 260-413 |
| 1993-91 | (V6) | 4.3L (262) Z | 260-412 |
| 2010-57 | (V8) | 265, 267, 283, 302, 305, 307, 327, 350 to 1996 | 260-425 |

| CHEVY/GMC | | | |
|------------------|------|---------------------------------|---------|
| 1993-82 | (V6) | 2.8L (173) | 260-407 |
| 2012-85 | (V6) | 4.3L (262) N, Z | 260-412 |
| 1990-63 | (V6) | 4.8L (292) | 260-415 |
| 2005-76 | (V8) | 5.0L (305), (307); 5.4L (327) | 260-425 |
| 2002-73 | (V8) | 5.7L (350) | 260-425 |
| 2000-70 | (V8) | 6.0L (366); 7.4L (454) | 260-426 |
| 2002-82 | (V8) | 6.2L (379) Diesel, (395) Diesel | 260-421 |

| Year | Cyl. | Application | Kit No. |
|-----------------------|------|------------------------------------|---------|
| CHRYSLER/DODGE | | | |
| 2000-82 | (4) | 2.2L (135) OHC 2.5L (153) OHC | 260-434 |
| 2003-88 | (V6) | 3.0L (181) | 260-430 |
| 2010-94 | (V6) | 3.3L (201) | 260-436 |
| 2010-90 | (V6) | 3.3L (201); 3.5L (215); 3.8L (230) | 260-432 |

| FORD/FORD TRUCK | | | |
|------------------------|------|--|---------|
| 2011-84 | (4) | 2.3L (140) OHC | 260-446 |
| 2009-86 | (V6) | 3.0L (182) exc. SHO engine | 260-448 |
| 2004-82 | (V6) | 3.8L (232) | 260-442 |
| 1996-65 | (V6) | 4.9L (300, 300) LD | 260-450 |
| 2012-97 | (V8) | 4.6L (281) | 260-457 |
| 2001-68 | (V8) | 4.7L (289); 5.0L (302) 5.8L (351) W | 260-451 |
| 1997-73 | (V8) | 6.1L (370); 7.0L (429) 7.5L (460) | 260-455 |

| OLDSMOBILE | | | |
|-------------------|------|---|---------|
| 1995-89 | (4) | 2.3L (138) | 260-418 |
| 1992-78 | (4) | 2.5L (151) 1, 5, 9, R, V | 260-400 |
| 1989-79 | (V6) | 2.8L (173) W, X, Z | 260-407 |
| 2000-88 | (V6) | 3.0L (181) E, L 3.8L (231) A, B, C, 2, 3 4.1L (252) | 260-410 |
| 2001-91 | (V8) | 4.3L (260) F, 8, (260) Diesel 5.0L (307) Y 5.7L (350) R, (350) N Diesel | 260-413 |
| 1992-77 | (V8) | 4.4L (267) J 5.0L (305), (350) G, L | 260-425 |

| PONTIAC | | | |
|----------------|------|--|---------|
| 1991-87 | (4) | 1.8L (112) J, O, OHC, 112G 2.0L (122) B, K, M, P | 260-418 |
| 1991-77 | (4) | 2.5L (151) F, R, U, V, 1, 2, 5, 9 | 260-400 |
| 1989-79 | (V6) | 2.8L (173) L, S, W, X, Z, 1, 7, 9 | 260-407 |
| 2008-85 | (V6) | 3.0L (181) E, L, 3.8L (231) A, B, C, 2, 3 4.1L (252) | 260-410 |
| 1992-77 | (V8) | 5.0L (305); 5.7L (350L) | 260-425 |
| 2004-87 | (V8) | 5.7L (350R), (350N) Diesel 6.6L (403) | 260-413 |

EXPANSION PLUGS BOUCHONS D'EXPANSION

**260
Series**

- Also known as Frost Plugs, Welsh Plugs or Freeze-Out Plugs. Papco® Expansion Plugs are made of heavy gauge plated steel or solid brass to resist rust.

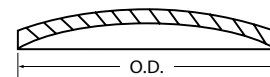

STANDARD TYPE TYPE REGULIER Standard Package / Contenant Régulier : $\frac{3}{8} - 1 \frac{5}{8} = 25$ pcs. $1 \frac{47}{64} - 3 = 12$ pcs.

| Stock No. STEEL | Stock No. BRASS | Nominal Plug Size | Reference O.D. +/- .005 |
|-----------------|-----------------|-------------------|-------------------------|
| 260-006 | 260-506 | 3/8 | .375 |
| 260-008 | | 7/16 | .437 |
| 260-010 | 260-510 | 1/2 | .500 |
| 260-012 | | 9/16 | .563 |
| 260-014 | | 5/8 | .625 |
| 260-016 | | 1-11/16 | .687 |
| 260-018 | 260-518 | 3/4 | .750 |
| 260-020 | | 13/16 | .812 |
| 260-022 | | 27/32 | .844 |
| 260-024 | 260-524 | 7/8 | .875 |
| 260-026 | 260-526 | 15/16 | .936 |
| 260-028 | 260-528 | 1 | 1.000 |
| 260-030 | 260-530 | 1-1/32 | 1.031 |
| 260-032 | 260-532 | 1-1/16 | 1.063 |
| 260-034 | 260-534 | 1-1/8 | 1.125 |
| 260-036 | 260-536 | 1-3/16 | 1.188 |

| Stock No. STEEL | Stock No. BRASS | Nominal Plug Size | Reference O.D. +/- .005 |
|-----------------|-----------------|-------------------|-------------------------|
| 260-039 | 260-539 | 1-1/4 | 1.250 |
| 260-042 | | 1-5/16 | 1.313 |
| 260-045 | 260-545 | 1-3/8 | 1.375 |
| 260-048 | 260-548 | 1-7/16 | 1.437 |
| 260-051 | 260-551 | 1-31/64 | 1.484 |
| 260-054 | | 1-1/2 | 1.500 |
| 260-057 | 260-557 | 1-5/8 | 1.625 |
| 260-060 | | 1-47/64 | 1.734 |
| 260-063 | 260-563 | 1-3/4 | 1.750 |
| 260-066 | 260-566 | 1-7/8 | 1.875 |
| 260-069 | 260-569 | 2 | 2.000 |
| 260-072 | | 2-1/16 | 2.063 |
| 260-075 | 260-575 | 2-7/64 | 2.105 |
| 260-078 | 260-578 | 2-1/4 | 2.250 |
| 260-081 | | 2-1/2 | 2.500 |
| 260-084 | | 2-3/4 | 2.750 |

CUP TYPE TYPE D'ASSIETTE Standard Package / Contenant Régulier = 12 pcs.

Plated Steel or Solid Brass / Acier Plaqué ou laiton massif

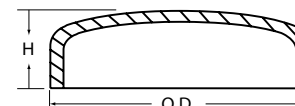

| Stock No. STEEL | Stock No. BRASS | Nominal Plug Size | Reference O.D. +/- .005 | H-Overall Height |
|-----------------|-----------------|-------------------|-------------------------|------------------|
| 260-100 | | 1/4 | .260 | .135 |
| 260-103 | | 5/16 | .3135 | .296 |
| 260-105 | | 3/8 | .385 | .240 |
| 260-108 | | 7/16 | .450 | .210 |
| 260-110 | 260-610 | 7/16 | .4445 | .156 |
| 260-111 | | 25/64 | .404 | .265 |
| 260-112 | | 29/64 | .460 | .270 |
| 260-113 | | 15/32 | .475 | .200 |
| 260-114 | | 1/2 | .527 | .312 |
| 260-115 | | 1/2 | .511 | .258 |
| 260-116 | | 35/64 | .5425 | .250 |
| 260-117 | | 33/64 | .512 | .248 |
| 260-118 | | 9/16 | .583 | .250 |
| 260-120 | | 19/32 | .594 | .281 |
| 260-121 | | 9/16 | .571 | .250 |
| 260-125 | | 21/32 | .658 | .266 |
| 260-126 | 260-626 | 5/8 | .6325 | .250 |
| 260-127 | | 43/64 | .662 | .235 |
| 260-128 | | 11/16 | .700 | .250 |
| 260-129 | | 41/64 | .635 | .233 |
| 260-130 | 260-630 | 3/4 | .7525 | .250 |
| 260-133 | | 51/64 | .789 | .312 |
| 260-134 | | 13/16 | .812 | .312 |
| 260-136 | | 7/8 | .888 | .312 |
| 260-138 | 260-638 | 29/32 | .912 | .390 |
| 260-140 | 260-640 | 59/64 | .925 | .335 |
| 260-141 | | 7/8 | .869 | .312 |
| 260-142 | | 15/16 | .945 | .375 |
| 260-143 | | 61/64 | .951 | .272 |
| 260-144 | 260-644 | 1 | 1.014 | .281 |
| 260-145 | | 1 | 1.009 | .295 |
| 260-146 | | 1-1/16 | 1.073 | .280 |
| 260-147 | | 1-5/64 | 1.072 | .280 |
| 260-150 | 260-650 | 1-1/8 | 1.133 | .437 |
| 260-153 | | 1-13/64 | 1.200 | .420 |
| 260-156 | | 1-7/32 | 1.228 | .531 |

| Stock No. STEEL | Stock No. BRASS | Nominal Plug Size | Reference O.D. +/- .005 | H-Overall Height |
|-----------------|-----------------|-------------------|-------------------------|------------------|
| 260-162* | | 1-1/4 | 1.2575 | .343 |
| 260-165 | | 1-1/4 | 1.258 | .437 |
| 260-168 | | 1-3/8 | 1.3875 | .500 |
| 260-171 | | 1-7/16 | 1.438 | .431 |
| 260-174 | | 1-1/2 | 1.522 | .375 |
| 260-177 | | 1-1/2 | 1.506 | .325 |
| 260-180 | 260-680 | 1-1/2 | 1.5075 | .625 |
| 260-183 | | 1-9/16 | 1.576 | .600 |
| 260-186 | 260-686 | 1-5/8 | 1.6375 | .593 |
| 260-189 | | 1-41/64 | 1.642 | .350 |
| 260-192* | | 1-45/64 | 1.7075 | .812 |
| 260-193 | | 1-45/64 | 1.638 | .350 |
| 260-194 | 260-694 | 1-3/4 | 1.7625 | .363 |
| 260-198 | 260-698 | 1-3/4 | 1.7625 | .593 |
| 260-204 | | 1-3/4 | 1.750 | .356 |
| 260-207 | 260-707 | 1-49/64 | 1.7655 | .406 |
| 260-210 | 260-710 | 1-7/8 | 1.8925 | .447 |
| 260-213 | | 1-57/64 | 1.883 | .266 |
| 260-216 | | 1-29/32 | 1.902 | .600 |
| 260-219 | 260-719 | 1-15/16 | 1.9475 | .800 |
| 260-222 | 260-722 | 1-61/64 | 1.9555 | .718 |
| 260-224 | | 1-61/64 | 1.956 | .295 |
| 260-225 | | 1-63/64 | 2.000 | .800 |
| 260-228 | 260-728 | 2 | 2.009 | .635 |
| 260-231 | | 2 | 2.008 | .415 |
| 260-234 | 260-734 | 2-1/64 | 2.0175 | .590 |
| 260-237 | 260-737 | 2-1/16 | 2.0675 | .510 |
| 260-240 | | 2-3/32 | 2.0975 | .610 |
| 260-243 | 260-743 | 2-1/8 | 2.145 | .430 |
| 260-246 | | 2-9/64 | 2.1485 | .600 |
| 260-249 | | 2-3/16 | 2.199 | .360 |
| 260-252 | 260-752 | 2-1/4 | 2.265 | .812 |
| 260-255 | | 2-17/64 | 2.264 | .355 |
| 260-260 | | 2-1/2 | 2.504 | .350 |
| 260-262 | | 2-1/2 | 2.500 | .340 |

**EXPANSION PLUGS
BOUCHON D'EXPANSION**

**260
Series**

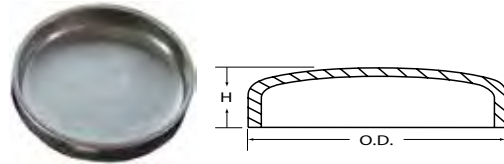

SHALLOW CUP TYPE TYPE D'ASSIETTE PEU PROFOND Standard Package / Contenant Régulier =12 pcs.

Plated Steel or Solid Brass / Acier Plaqué ou laiton massif

| Stock No. STEEL | Stock No. BRASS | Nominal Plug Size | Reference O.D. +/- .005 | H-Overall Height |
|-----------------|-----------------|-------------------|-------------------------|------------------|
| 260-303 | | 7/16 | .440 | .170 |
| 260-305 | | 29/64 | .450 | .203 |
| 260-307 | | 1/2 | .505 | .250 |
| 260-308 | | 17/32 | .541 | .187 |
| 260-309 | | 35/64 | .5425 | .187 |
| 260-311 | | 5/8 | .631 | .190 |
| 260-312 | | 45/64 | .700 | .205 |
| 260-313 | | 53/64 | .8235 | .250 |
| 260-315 | 260-815 | 1 | 1.010 | .290 |
| 260-318 | 260-818 | 1-1/4 | 1.2625 | .312 |
| 260-321 | | 1-21/64 | 1.3225 | .281 |
| 260-324 | 260-824 | 1-3/8 | 1.385 | .340 |
| 260-327 | 260-827 | 1-1/2 | 1.505 | .300 |
| 260-330 | | 1-9/16 | 1.570 | .315 |
| 260-333 | 260-833 | 1-5/8 | 1.640 | .345 |
| 260-336 | | 1-45/64 | 1.703 | .281 |
| 260-339 | 260-839 | 1-3/4 | 1.762 | .232 |
| 260-342 | | 1-51/64 | 1.8025 | .250 |

| Stock No. STEEL | Stock No. BRASS | Nominal Plug Size | Reference O.D. +/- .005 | H-Overall Height |
|-----------------|-----------------|-------------------|-------------------------|------------------|
| 260-345 | | 1-53/64 | 1.825 | .350 |
| 260-348 | | 1-29/32 | 1.915 | .265 |
| 260-351 | | 1-59/64 | 1.922 | .235 |
| 260-354 | | 1-31/32 | 1.9775 | .218 |
| 260-357 | | 2 | 2.025 | .406 |
| 260-359 | 260-859 | 2 | 2.010 | .310 |
| 260-362 | | 2-1/64 | 2.0175 | .240 |
| 260-365 | 260-865 | 2-1/16 | 2.0725 | .343 |
| 260-366 | | 2-1/16 | 2.062 | .343 |
| 260-372 | | 2-7/64 | 2.109 | .310 |
| 260-375 | | 2-9/64 | 2.135 | .360 |
| 260-378 | | 2-5/32 | 2.1535 | .328 |
| 260-381 | 260-881 | 2-3/16 | 2.200 | .355 |
| 260-383 | | 2-3/16 | 2.192 | .343 |
| 260-385 | | 2-7/32 | 2.2205 | .305 |
| 260-388 | | 2-1/4 | 2.262 | .350 |
| 260-391 | | 2-3/8 | 2.385 | .312 |
| 260-394* | | 2-9/16 | 2.575 | .301 |

* With reverse taper

GARAGE ASSORTMENT

No. 020-048

Contains 50 Standard and Cup Type expansion plugs.
For more details see page 3.



MASTER ASSORTMENTS

No. 020-633

Contains 110 Cup & Shallow Cup Types.
For more details see page 8.

020-633



No. 020-640

Contains 140 Standard & Cup Types.
For more details see page 8.

020-640



020-800

'SUPER SERVICE' ASSORTMENTS

No. 020-800

Contains 200 Standard & Cup Types.
See page 10 for more details.

No. 020-801

Contains 170 Cup & Shallow Cup Types.
See page 10 for more details.

METRIC EXPANSION PLUGS BOUCHON D'EXPANSION MÉTRIQUE

**261
Series**

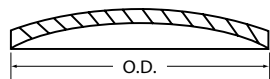

STANDARD TYPE

TYPE RÉGULIER Plated Steel / Acier Plaqué

Standard Package / Contenant Régulier = 10 pcs.

| Stock No. | Nominal O.D. | Stock No. | Nominal O.D. |
|-----------|--------------|-----------|--------------|
| 261-011 | 16 mm | 261-064 | 40 mm |
| 261-014 | 18 mm | 261-069 | 42 mm |
| 261-024 | 24 mm | 261-077 | 45 mm |
| 261-026 | 25 mm | 261-090 | 52 mm |
| 261-046 | 35 mm | 261-096 | 55 mm |

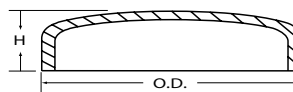

SHALLOW CUP TYPE

TYPE D'ASSIETTE PEU PROFOND

Plated Steel / Acier Plaqué

Standard Package / Contenant Régulier = 10 pcs.

| Stock No. | Nominal O.D. | Stock No. | Nominal O.D. |
|-----------|--------------|-----------|--------------|
| 261-326 | 25 mm | 261-367 | 42 mm |
| 261-347 | 35 mm | 261-377 | 45 mm |
| 261-364 | 40 mm | | |

CUP TYPE TYPE D'ASSIETTE

Standard Package /
Contenant Régulier = 10 pcs.

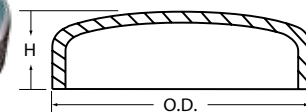

| Stock No. | Nominal O.D. | H - Nominal Height (mm) |
|-----------|--------------|-------------------------|
| 261-103 | 11 mm | 4.85 |
| 261-105 | 12 mm | 5.3 |
| 261-107 | 14 mm | 5.0 |
| 261-108 | 14.4 mm | 5.5 |
| 261-109 | 15 mm | 5.5 |
| 261-111 | 16 mm | 9.1 |
| 261-114 | 18 mm | 5.9 |
| 261-117 | 20 mm | 7.0 |
| 261-118 | 20 mm | 6.0 |
| 261-121 | 22 mm | 7.5 |
| 261-124 | 24 mm | 6.9 |
| 261-126 | 25 mm | 8.3 |
| 261-129 | 27 mm | 8.4 |
| 261-132 | 28 mm | 8.7 |
| 261-135 | 29 mm | 11.4 |
| 261-138 | 30 mm | 8.1 |
| 261-140 | 31.5 mm | 8.5 |
| 261-142 | 32 mm | 9.5 |
| 261-145 | 34 mm | 12.7 |

| Stock No. | Nominal O.D. | H - Nominal Height (mm) |
|-----------|--------------|-------------------------|
| 261-146 | 35 mm | 10.6 |
| 261-149 | 36 mm | 8.5 |
| 261-150 | 36.5 mm | 9.0 |
| 261-155 | 38 mm | 7.9 |
| 261-158 | 39 mm | 9.5 |
| 261-161 | 40 mm | 11.7 |
| 261-162 | 40 mm | 12.8 |
| 261-165 | 41 mm | 11.9 |
| 261-170 | 42.3 mm | 10.0 |
| 261-171 | 42.6 mm | 10.0 |
| 261-173 | 44 mm | 11.9 |
| 261-177 | 45 mm | 11.9 |
| 261-178 | 45 mm | 13.5 |
| 261-181 | 47 mm | 7.4 |
| 261-184 | 49.5 mm | 11.0 |
| 261-185 | 50 mm | 12.0 |
| 261-186 | 50 mm | 14.8 |
| 261-188 | 51 mm | 5.55 |

MASTER ASSORTMENTS



020-666

No. 020-666

Contains 120 Metric Standard & Cup Types.
See page 8 for more details.

'SUPER SERVICE' ASSORTMENTS



020-840

No. 020-840

Contains 180 Metric Standard & Cup Types.
See page 10 for more details.

No. 020-841

Contains 150 Metric Cup & Shallow Cup Types.
See page 10 for more details.

'E-Z SEAL' EXPANSION PLUGS
BOUCHONS D'EXPANSION 'E-Z SEAL'

263 Series

An Expansion Plug designed to save mechanic's time... will save hours of repair time in replacing core hole plugs, by simply tightening, even when Starter, Generator, Distributor, Manifold, Steering Linkage or Air Conditioner Components interfere.

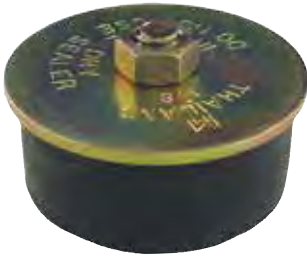

- Slips in easily.
- Can be finger-tightened.
- Permanently set with open end wrench.
- No metal comes in contact with the coolant.
- Body of plug is specially compounded Neoprene, resistant to heat, antifreeze, and rust inhibitors.
- Expands as much as 1/8" to seal tightly against irregularities.

EXPANSION PLUGS

Order by Stock Number

| Stock No. | Size | Metric Equiv. |
|-----------|-------|---------------|
| 263-548 | 3/4 | 19 mm |
| 263-556 | 7/8 | 22 mm |
| 263-564 | 1 | 25 mm |
| 263-572 | 1-1/8 | 29 mm |

| Stock No. | Size | Metric Equiv. |
|-----------|-------|---------------|
| 263-580 | 1-1/4 | 32 mm |
| 263-588 | 1-3/8 | 35 mm |
| 263-596 | 1-1/2 | 38 mm |
| 263-604 | 1-5/8 | 41 mm |

| Stock No. | Size | Metric Equiv. |
|-----------|-------|---------------|
| 263-612 | 1-3/4 | 45 mm |
| 263-628 | 2 | 51 mm |
| 263-636 | 2-1/8 | 54 mm |
| 263-644 | 2-1/4 | 57 mm |

OIL DRAIN PLUGS

| Stock No. | Size | Metric Equiv. |
|-----------------------------------|------|---------------|
| 'E-Z SEAL' OIL DRAIN PLUGS | | |
| 263-290 | 7/16 | 12 mm |
| 263-320 | 1/2 | 13 mm |
| 263-322 | 9/16 | 14 mm |
| 263-400 | 5/8 | 16 mm |

- Install dry.
- Do not use sealer.
- Do not use where petroleum products contact rubber.
- Do not overtighten.
- *Installez à sec.*
- *N'employez pas de l'adhésif.*
- *N'employez pas où des produits de pétrole viendront en contact avec le néoprène.*
- *Ne pas trop serrer.*

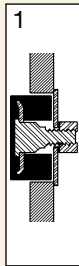

- Make sure washer and nut are loose.
- Washer must be flush with side of wall before and after plug is installed.
- Plug must extend 1/4" beyond inside wall to allow a ridge to form.
- Turn the nut clockwise 2 or 3 turns to form a ridge and properly set plug.
- When properly installed, plug will hold pressure to 50 P. S. I.
- *Assurez-vous que la rondelle et l'écrou ne sont pas lâches.*
- *La rondelle doit être égale avec le côté du mur avant d'être installée.*
- *Le tampon doit dépasser le mur intérieure d'aux moins 1/4 de pouce pour permettre la formation d'un coussin.*
- *Pour bien placer le tampon, serrez l'écrou de 2 ou 3 tours.*
- *Quand bien installé, le tampon soutiendra une pression de 50 P. S. I.*

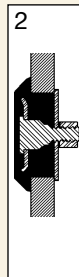

MERCHANDISER No. 022-123

Includes Rack, Header Sign, Inventory Control, Planogram and a 20 card stock of 'E-Z Seal Plugs' listed above.



ASSORTMENT No. 020-318

Contains 13 'E-Z Seal' Expansion Plugs - one of each size. Have every size on hand - repair leaking metal frost plugs in all locations - whether hard or easy to get to.

Contient 13 bouchons d'expansion 'E-Z Seal' - un de chaque format. Ayez tous les formats en main. Réparez les bouchons en métal protégeant contre la gelée à tous les endroits - difficiles ou faciles à rejoindre.



AN INTRODUCTION TO...

DRAIN PLUGS

BOUCHONS DE VIDANGE

...UNE INTRODUCTION.

www.hpaulin.com

For a full listing of Papco® Oil Drain Plugs and application guide, please refer to our current catalogue or visit our website to download a PDF version.



DRAIN AND FILLER PLUGS

DRAIN PLUGS GASKET

OIL DRAIN PLUG REPAIR

DUO-DRAIN OIL PLUG

**CARDED MAGNETIC DRAIN
with GASKET**

**MAGNETIC DRAIN PLUG
with GASKET**



**DRAIN AND FILLER PLUGS
BOUCHONS DE VIDANGE ET REMPLISSAGE**

263 Series

Papco[®] Drain Plugs are manufactured in nine types and are available in Inch and Metric sizes. Type 2 oversized plugs are tapered, hardened and cut their own thread where the original has been stripped. To use an oversized plug, hold in a straight position and tighten with a socket wrench. Plug is then removed to clear metal particles and then reinstalled. Each Drain Plug is supplied with a gasket, as indicated in the gasket chart, with an asterisk (*) unless otherwise indicated.

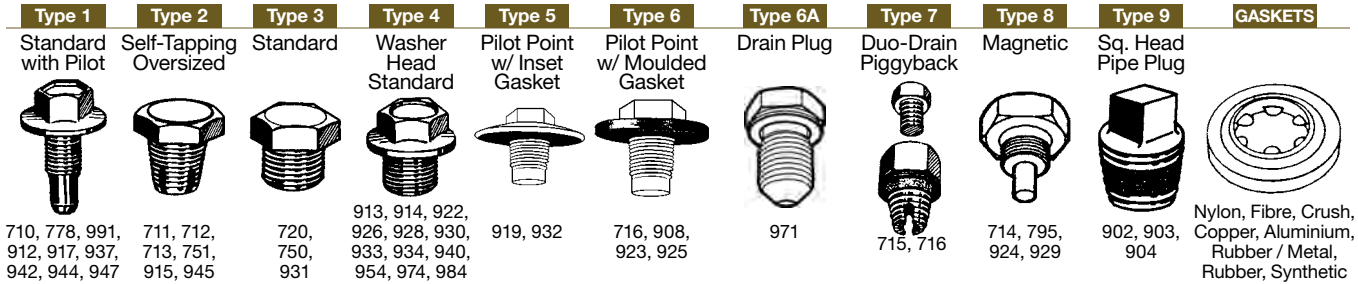

| DRAIN PLUGS | | | | GASKETS | | | | All Gasket Standard Packages 25 Pieces | | | |
|-------------|---|------|-----------|----------|----------|----------|----------|--|----------------|---------|-----------|
| Stock No. | Size & Thread | Type | Std. Pkg. | Nylon | Fibre | Copper | Crush | Aluminum | Rubber / Metal | Rubber | Synthetic |
| 263-710 | 1/2-20 Std. | 1 | 5 | 263-816* | 263-800 | 263-856 | | 263-869 | 263-875 | | 263-885 |
| 263-711 | 1/2-20 S.O. Self-Tap | 2 | 12 | 263-816* | 263-801 | 263-856 | 263-844 | | 263-875 | | |
| 263-712 | 1/2-20 D.O. Self-Tap | 2 | 12 | 263-817* | 263-801 | 263-857 | | 263-870 | | | |
| 263-713 | 1/2-20 T.O. Self-Tap | 2 | 12 | 263-817* | 263-802 | 263-860 | | | | | |
| 263-714 | 1/2-20 Magnetic | 8 | 5 | 263-816* | 263-800 | 263-856 | | | 263-875 | | |
| 263-715 | 1/2-20 D.O. Duo-Drain | 7 | 5 | 263-817* | 263-801 | 263-857 | | 263-870 | | | |
| 263-716 | 1/2-20 Std. Duo-Drain | 7 | 5 | 263-816* | 263-800 | 263-856 | | | 263-875 | | |
| 263-718 | 1/2-20 Pilot Pt. w/ Molded Gasket | 6 | 5 | N/R | N/R | N/R | N/R | N/R | N/R | N/R | N/R |
| 263-720 | 5/8-18 Std. | 3 | 5 | 263-820* | | 263-857 | | | | | |
| 263-750 | 3/4-16 Std. | 3 | 5 | 260-824* | 263-804 | | 263-851 | | | | |
| 263-751 | 3/4-16 S.O. Self-Tap | 2 | 5 | 263-824* | 263-805 | | 263-851 | | | | |
| 263-778 | 1/2-20 Std. | 1 | 5 | 263-816 | 263-800 | 263-856 | | 263-869 | 263-875* | | 263-885 |
| 263-795 | 1/2-20 Magnetic | 8 | 5 | 263-816 | 263-800 | 263-856 | | 263-869 | 263-875* | | 263-885 |
| 263-908 | M12 x 1.75 Pilot Pt. w/ Moulded Gasket | 6 | 5 | N/R | N/R | N/R | N/R | N/R | N/R | N/R | N/R |
| 263-911 | M12 x 1.75 Std. with Pilot Pt. | 1 | 5 | 263-815* | 263-808 | 263-855 | | 263-869 | 263-875 | 263-874 | |
| 263-912 | M12 x 1.25 Std. with Pilot Pt. | 1 | 5 | 263-815* | 263-808 | 263-855 | | 263-869 | 263-875 | 263-874 | |
| 263-913 | M12 x 1.25 Std. | 4 | 5 | 263-815* | 263-808 | 263-855 | | 263-869 | 263-875 | 263-874 | |
| 263-914 | M14 x 1.5 Std. | 4 | 5 | 263-817* | 263-801 | 263-856 | 263-844 | 263-870 | 263-876 | | |
| 263-915 | M14 x 1.5 S.O. Self-Tap | 2 | 5 | 263-817* | | 263-860 | | | | | |
| 263-917 | M14 x 1.5 Std. with Pilot | 1 | 5 | 263-817* | 263-801 | 263-856 | 263-844 | 263-870 | 263-876 | | |
| 263-919 | M12 x 1.75 Pilot Pt. w/Inset Gasket | 1 | 5 | N/R | N/R | N/R | N/R | N/R | N/R | N/R | N/R |
| 263-922 | M14 x 1.25 Std. | 4 | 5 | 263-817* | 263-801 | 263-856 | 263-844 | 263-870 | 263-876 | | |
| 263-923 | M14 x 1.5 Pilot Pt. w/ Molded Gasket | 6 | 5 | N/R | N/R | N/R | N/R | N/R | N/R | N/R | N/R |
| 263-924 | M14 x 1.5 Magnetic | 8 | 5 | 263-817* | 263-801 | 263-856 | 263-844 | 263-870 | 263-876 | | |
| 263-925 | M14 x 1.5 Pilot Pt. w/ Inset Gasket | 6 | 5 | N/R | N/R | N/R | N/R | N/R | N/R | N/R | N/R |
| 263-928 | M18 x 1.5 Std. | 4 | 5 | 263-824 | 263-810* | | | 263-873 | | | |
| 263-929 | M12 x 1.75 Magnetic w/PP & Inset Gasket | 8 | 5 | N/R | N/R | N/R | N/R | N/R | N/R | N/R | N/R |
| 263-930 | M20 x 1.5 Std. | 4 | 5 | 263-824 | 263-807 | | 263-851* | | | | |
| 263-931 | M12 x 1.5 Std. | 3 | 5 | 263-815 | 263-808 | 263-855 | | 263-869* | 263-875 | 263-874 | |
| 263-932 | M12 x 1.75 Pilot Pt. w/ Inset Gasket | 5 | 5 | N/R | N/R | N/R | N/R | N/R | N/R | N/R | N/R |
| 263-933 | M12 x 1.25 Std. | 4 | 5 | 263-815 | 263-808 | 263-855 | | 263-869 | 263-875 | 263-874 | 263-885* |
| 263-934 | M14 x 1.5 Std. | 4 | 5 | 263-817 | 263-801 | 263-856 | 263-844 | 263-870* | 263-876 | | |
| 263-937 | M14 x 1.5 Pilot Pt. | 1 | 5 | 263-817 | 263-801 | 263-856 | 263-844 | 263-870 | 263-876* | | |
| 263-940 | M22 x 1.5 Std. | 4 | 5 | 263-828* | | | | | | | |
| 263-942 | M12 x 1.25 Pilot Pt. | 1 | 5 | 263-815 | 263-808 | 263-855 | | 263-869* | 263-875 | 263-874 | 263-885 |
| 263-944 | M12 x 1.75 Pilot Pt. | 1 | 5 | 263-815 | 263-808 | 263-855 | | 263-870 | 263-875* | 263-874 | |
| 263-945 | M12 x 1.75 S.O. Self-Tap | 2 | 5 | 263-817 | 263-801 | 263-855 | 263-844 | 263-870 | 263-876* | | |
| 263-947 | M14 x 1.5 Pilot Pt. | 1 | 5 | 263-817 | 263-801 | 263-856* | 263-844 | 263-870 | 263-876 | | |
| 263-950 | M14 x 1.5 Std. w/Inset Gasket | 5 | 5 | N/R | N/R | N/R | N/R | N/R | N/R | N/R | N/R |
| 263-954 | M14 x 1.5 Std. | 4 | 5 | 263-817 | 263-801 | 263-856* | 263-844 | 263-870 | 263-876 | | |
| 263-958 | M14 x 1.5 Pilot Pt. w/ Inset Gasket | 5 | 5 | N/R | N/R | N/R | N/R | N/R | N/R | N/R | N/R |
| 263-960 | M 14 x 1.5 Std. | 5 | 5 | 263-817 | 263-801 | 263-856 | 263-844 | 263-870* | 263-876 | | |
| 263-971 | M14 x 1.5 Std. w/Floating Gasket | 6A | 5 | N/R | N/R | N/R | N/R | N/R | N/R | N/R | N/R |
| 263-974 | M14 x 1.5 Std. | 4 | 5 | 263-817 | 263-801 | 263-856 | 263-844* | 263-870 | 263-876 | | |
| 263-984 | M14 x 1.5 Std. | 4 | 5 | 263-817 | 263-801 | 263-856 | 263-844 | 263-870 | 263-876* | | |
| 263-990 † | UNIV. 1/2-3/4, 12-18mm | - | 3 | N/R | N/R | N/R | N/R | N/R | N/R | N/R | N/R |
| 260-902 | 1/4" Sq. Pipe Plug | 9 | 12 | | | | | | | | |
| 260-903 | 3/8" Sq. Pipe Plug | 9 | 12 | | | | | | | | |
| 260-904 | 1/2" Sq. Pipe Plug | 9 | 12 | | | | | | | | |

* - Indicates type of gasket supplied with plug.

**FOR A MORE COMPREHENSIVE LISTING OF THESE PARTS,
PLEASE REFER TO OUR CURRENT OIL DRAIN PLUGS CATALOGUE**

DRAIN PLUG GASKETS JOINTS POUR BOUCHONS DE VIDANGE

263 Series

Papco[®] Selon[®] Drain Plug Gaskets are made of special nylon with excellent mechanical properties and long life. Also available are copper and fibre gaskets as well as aluminium, rubber/metal and synthetic gaskets.



Fibre



Nylon



Crush



Copper



Alum.



Rubber



Synthetic

Order by Stock Number

Standard Packages 25 Pieces

| Part # | I.D. x O.D. x Thick | Part # | I.D. x O.D. x Thick | Part # | I.D. x O.D. x Thick |
|---------|---------------------------|---------|-----------------------------|---------|---------------------------------|
| 263-800 | Fibre 1/2 x 3/4 x 3/32 | 263-816 | Nylon 9/16 x 13/16 x .052 | 263-860 | Copper 3/4 x 1-1/16 x .062 |
| 263-801 | Fibre 9/16 x 13/16 x 3/32 | 263-817 | Nylon 5/8 x 15/16 x .059 | 263-869 | Alum. 15/32 x 7/8 x .080 |
| 263-802 | Fibre 5/8 x 7/8 x 3/32 | 263-820 | Nylon 11/16 x 1 x .062 | 263-870 | Alum. 14mm x 20mm x .078 |
| 263-804 | Fibre 3/4 x 1-1/16 x 3/32 | 263-824 | Nylon 13/16 x 1-1/16 x .082 | 263-873 | Alum. 18mm x 26mm x .078 |
| 263-805 | Fibre 13/16 x 1 x 3/32 | 263-828 | Nylon 31/64 x 1-1/4 x .078 | 263-874 | Rubber 12mm x 20mm x .102 |
| 263-807 | Fibre .920 x 1-1/8 x 3/32 | 263-844 | Crush 17/32 x 3/4 x .080 | 263-875 | Rubber/Met.12mm x 25mm x .078 |
| 263-808 | Fibre 12mm x .748 x 3/32 | 263-851 | Crush 25/32 x 1 x .087 | 263-876 | Rubber/Met.17/32 x 31/32 x .081 |
| 263-809 | Fibre 16mm x 1.062 x 3/32 | 263-855 | Copper 31/64 x 3/4 x .094 | 263-885 | Synthetic 15/32 x 15/16 x .078 |
| 263-810 | Fibre 18mm x 1.062 x 3/32 | 263-856 | Copper 19/32 x 13/16 x .062 | | |
| 263-815 | Nylon 31/64 x 3/4 x .052 | 263-857 | Copper 5/8 x 1 x .062 | | |

OIL DRAIN PLUG REPAIR RÉPARATION DE BOUCHON DE VIDANGE

263 Series

No. 263-990

Exclusively patented winged drain plug is used when the oil pan or flange is broken or missing.

Eliminating the need to replace the pan.

Part number 263-990 is a time and money saver for pans with 1/2" to 3/4" or 12mm to 18mm drain holes.

Requires no tools to install.



263-990

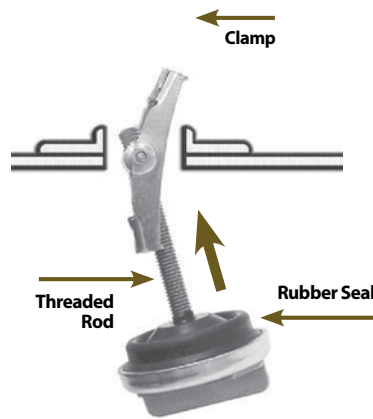

Fig. 1

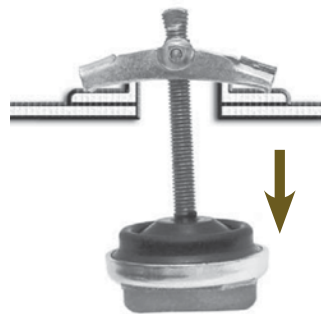

Fig. 2



Fig. 3

CAUTION: DO NOT use on Honda or Volkswagen. Make sure threaded bolt will not contact any internal parts before installation. Bolt enters oil pan 1-7/8".

CAUTION: This type of plug is designed to be HAND TIGHTENED ONLY.

DUO-DRAIN[®] OIL PLUGS
BOUCHONS D'HUILE DUO-DRAIN[®]

263 Series

BRIGHT PLATED

All metal, two-part plug for repairing 1/2"-20 crankcase applications on GM, Ford, Chrysler and AMC. STANDARD or Self-tapping DOUBLE OVERSIZE outer plug installs permanently. Only the pipe threaded centre plug is removed to drain oil. Convenient skin-packed card contains one (1) Duo-Drain Oil Plug complete with gasket.

1/2 Standard

No. 263-798



1/2-20 D.O.

No. 263-799



CARDED DRAIN PLUGS WITH GASKET
BOUCHONS DE VIDANGE AVEC JOINT

| Card No. | Size & Type | Card No. | Size & Type |
|----------|---------------------------|----------|----------------------|
| 263-777 | M14 x 1.5 Pilot Pt. | 263-790 | 1/2-20 Std. |
| 263-780 | M12 x 1.75 Std. Pilot Pt. | 263-791 | 1/2-20 S.O. Self-Tap |
| 263-782 | 1/2-20 T.O. Self-Tap | 263-792 | 1/2-20 D.O. Self-Tap |
| 263-783 | 1/2-20 Magnetic | 263-793 | 1/2-20 T.O. Self-Tap |
| 263-784 | M14 x 1.5 Magnetic | 263-794 | 1/2-20 Magnetic |
| 263-786 | M14 x 1.5 Pilot Pt. | 263-796 | M14 x 1.5 Pilot Pt. |
| 263-787 | M12 x 1.75 Pilot Pt. | 263-797 | M12 x 1.75 Magnetic |
| 263-788 | M12 x 1.75 Pilot Pt. | 263-798 | M14 x 1.5 |
| | | 263-799 | 1/2-20 Duo |

1/2-20 S.O.
M12 x 1.75
Pilot Pt. with
Inset Gasket



263-791

MAGNETIC DRAIN PLUGS WITH GASKET
BOUCHONS DE VIDANGE MAGNÉTIQUE AVEC JOINT

263 Series

Papco[®] Magnetic Drain Plugs reduce wear and protect engines by attracting harmful metal particles circulating in the crankcase oil. Powerful, long-lasting ALNICO magnet. Install in place of ordinary plugs. Individually skin-packed with gasket.

| Card No. | Size & Thread | Gasket |
|----------|---------------------|---------|
| 263-783 | 1/2-20 Magnetic | 263-817 |
| 263-784 | 14mm x 1.5 Magnetic | 263-817 |

| Card No. | Size & Thread | Gasket |
|----------|--|---------|
| 263-794 | 1/2-20 Std. Magnetic | 263-816 |
| 263-797 | M12 x 1.75 Pilot Pt.- with Inset Gasket | — |

1/2-20 S.O.
Magnetic



263-783

DRAIN PLUGS WITH GASKET BOUCHONS DE VIDANGE AVEC JOINT

GARAGE ASSORTMENT

No. 020-032

Contains 7 Self-Tapping Oversize Drain Plugs with gaskets. (4) 1/2-20 O.S.; (2) 1/2-20 D. O.; (1) 1/2-20 T.O.



020-032

GARAGE ASSORTMENT

No. 020-038

Contains 9 Inch and Metric Drain Plugs with gaskets. (4) 1/2-20 Std. (3) 12mm x 1.75, (2) 14mm x 1.5.



020-038

GARAGE ASSORTMENT

No. 020-054

Contains 60 Nylon Gaskets in six popular sizes for Inch and Metric Drain Plugs.



020-054

MASTER GASKET ASSORTMENT

No. 020-607

Contains 210 pieces - 20 of the most popular sizes of Nylon, Copper, Fiber, Aluminum and Rubber/Metal Drain Plug Gaskets.



020-607

MASTER DRAIN PLUG ASSORTMENT

No. 020-630

Contains 40 Inch and Metric Drain Plugs; 73 Gaskets - and includes:
 - Magnetic and 1/2-20 oversize plugs.
 - 17 sizes of Plugs, 8 Sizes of Gaskets.
 - Complete coverage for most vehicles.



020-630

**OIL DRAIN PLUGS AND GASKETS MERCHANDISER
PRÉSENTOIR DE BOUCHONS DE VIDANGE ET JOINTS**

No. 998651

- 42 SKUs of the best plugs and gaskets for domestic and import vehicles
- Prepack includes 84 clamshells.
- Planogram space specifications: 11 inches wide x 24 inches tall.
- 42 peg hooks included.
- Merchandise on standard peg board.
- Products include merchandise location code
- Laminated hanging application guide included
- Please contact your local sales representative for additional information

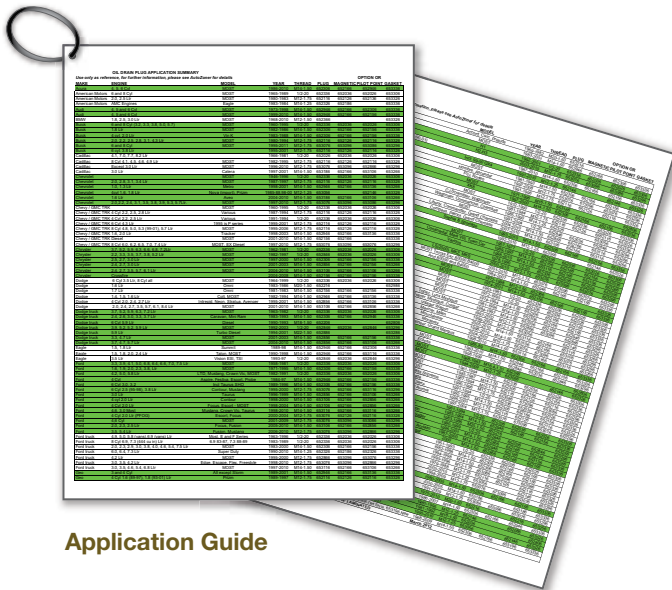

Application Guide

| OIL DRAIN PLUGS AND GASKETS MERCHANDISER | | | | | | | |
|--|---------------|---|-----|----------|-----------------|---|-----|
| Part No. | Size | Description | Qty | Part No. | Size | Standard | Qty |
| 400804 | 3/8 | Square Pipe Plug | 2 | 652326 | M14 x 1.25 | Standard | 2 |
| 400814 | 1/2 | Square Pipe Plug | 2 | 652306 | M14 x 1.50 | Standard (0.62" shank) | 2 |
| 652006 | 1/2 | Universal Rubber Plug | 2 | 652946 | M14 x 1.50 | Standard (0.43" shank) | 2 |
| 652016 | 5/8 | Universal Rubber Plug | 2 | 652176 | M14 x 1.50 S.O. | Single Oversize | 2 |
| 652026 | 1/2-20 | Standard (0.85" shank) | 2 | 652156 | M14 x 1.50 | Standard Pilot Point | 2 |
| 652336 | 1/2-20 | Standard (0.5" shank) | 2 | 653106 | M14 x 1.50 | Standard Pilot Point w/Inset Gasket (0.71" shank) | 2 |
| 652846 | 1/2-20 | Standard Pilot Point w/Inset Gasket | 2 | 653116 | M14 x 1.50 | Standard Pilot Point w/Inset Gasket (0.75" shank) | 2 |
| 652036 | 1/2-20 | Magnetic Standard | 2 | 652856 | M14 x 1.50 | Standard Pilot Point w/Inset Gasket (0.67" shank) | 2 |
| 652046 | 1/2-20 S.O. | Self-Tap Single Oversize | 2 | 652166 | M14 x 1.50 | Magnetic Standard | 2 |
| 652056 | 1/2-20 S.O. | Magnetic Single Oversize | 2 | 653136 | M14 x 1.50 | Standard (Easy Seal) | 2 |
| 652066 | 1/2-20 D.O.S. | Self-Tap Double Oversize | 2 | 652206 | M18 x 1.50 | Standard | 2 |
| 652933 | 3/4 | Rubber Differential Plug | 2 | 652886 | M22 x 1.50 | Standard | 2 |
| 653056 | M12 x 1.25 | Standard | 2 | 653016 | 12mm | Nylon | 2 |
| 652116 | M12 x 1.75 | Standard Pilot Point | 2 | 653296 | 12mm | Rubber | 2 |
| 653076 | M12 x 1.75 | Standard Pilot Point w/Inset Gasket (0.95" shank) | 2 | 652806 | M12-M18 | Fiber Assortment | 2 |
| 652866 | M12 x 1.75 | Standard Pilot Point w/Inset Gasket (0.68" shank) | 2 | 652816 | M12-M16 | Copper Assortment | 2 |
| 653086 | M12 x 1.75 | Standard Pilot Point w/Inset Gasket (0.95" shank) | 2 | 653306 | 1/2" | Gasket Assortment | 2 |
| 652126 | M12 x 1.75 | Magnetic Standard | 2 | 653316 | 1/2" O.S. | Gasket Assortment | 2 |
| 653096 | M12 x 1.75 | Magnetic Standard w/Pilot Point & Inset Gasket | 2 | 653326 | M12 | Gasket Assortment | 2 |
| 652136 | M12 x 1.75 | Self-Tap Single Oversize | 2 | 653336 | M14 | Gasket Assortment | 2 |
| 652146 | M12 x 1.25 | Standard Pilot Point | 2 | 653346 | M18-M22 | Gasket Assortment | 2 |

RINGS AND KEYSTOCK

ANNEAUX ET CLÉS



SNAP RINGS

SNAP RING PLIERS

WOODRUFF KEYS

'O'-RINGS, UNIVERSAL

AXLE SHAFT KEY STOCK

AXLE KEYS

HOLE PLUGS

MECHANICS' WIRE

**SNAP RINGS
CIRCLIPS**

**268
Series**

High Carbon Steel • Retainer Rings • Heat Treated for Resiliency

Used as retainers on automotive, appliance and heavy equipment applications. Packaged in uniformly priced transparent packs. Number of rings per pack is shown below.

ORDER BY STOCK NUMBER

| -200 Series Internal | -300 Series Internal | -400 Series External | -500 Series External | -600 Series External | -700 Series External | | | | |
|--------------------------|-------------------------|-------------------------|-------------------------|-------------------------|-------------------------|--------------|------------|---------------|-----------------|
| Stock No. | Industry No. | Housing Dia. | Free Dia. "A" | Pieces Per Pack | Stock No. | Industry No. | Shaft Dia. | Free Dia. "A" | Pieces Per Pack |
| Internal Types (Housing) | | | | | External Types (Shaft) | | | | |
| 268-222 | 5000-50 | 1/2 | .548 | 10 | 268-436 | 5100-131 | 1-5/16 | 1.214 | 4 |
| 268-224 | 5000-62 | 5/8 | .694 | 10 | 268-438 | 5100-137 | 1-3/8 | 1.272 | 4 |
| 268-226 | 5000-75 | 3/4 | .831 | 8 | 268-440 | 5100-150 | 1-1/2 | 1.387 | 3 |
| 268-227 | 5000-81 | 13/16 | .901 | 8 | 268-442 | 5100-175 | 1-3/4 | 1.618 | 2 |
| 268-228 | 5000-87 | 7/8 | .971 | 6 | 268-444 | 5100-200 | 2 | 1.850 | 2 |
| 268-230 | 5000-100 | 1 | 1.111 | 6 | 268-505 | 5133-12 | 1/8 | .094 | 18 |
| 268-231 | 5000-106 | 1-1/16 | 1.180 | 5 | 268-506 | 5133-15 | 5/32 | .114 | 18 |
| 268-232 | 5000-112 | 1-1/8 | 1.249 | 5 | 268-510 | 5133-18 | 3/16 | .122 | 18 |
| 268-234 | 5000-125 | 1-1/4 | 1.388 | 4 | 268-511 | 5133-18 | 3/16 | .145 | 18 |
| 268-237 | 5000-137 | 1-3/8 | 1.526 | 4 | 268-514 | 5133-25 | 1/4 | .207 | 18 |
| 268-238 | 5000-150 | 1-1/2 | 1.660 | 3 | 268-516 | 5133-31 | 5/16 | .243 | 18 |
| 268-242 | 5000-175 | 1-3/4 | 1.942 | 2 | 268-518 | 5133-37 | 3/8 | .300 | 14 |
| 268-246 | 5000-200 | 2 | 2.210 | 2 | 268-520 | 5133-43 | 7/16 | .337 | 14 |
| 268-329 | 5008-093 | 15/16 | 1.015 | 6 | 268-522 | 5133-50 | 1/2 | .392 | 12 |
| 268-330 | 5008-100 | 1 | 1.081 | 6 | 268-606 | 5144-15 | 5/32 | .113 | 18 |
| 268-332 | 5008-112 | 1-1/8 | 1.217 | 5 | 268-610 | 5144-18 | 3/16 | .143 | 18 |
| External Types (Shaft) | | | | | 268-614 | 5144-25 | 1/4 | .204 | 18 |
| 268-414 | 5100-25 | 1/4 | .225 | 15 | 268-616 | 5144-31 | 5/16 | .242 | 18 |
| 268-418 | 5100-37 | 3/8 | .338 | 14 | 268-618 | 5144-37 | 3/8 | .292 | 14 |
| 268-422 | 5100-50 | 1/2 | .461 | 10 | 268-620 | 5144-56 | 9/16 | .430 | 9 |
| 268-424 | 5100-62 | 5/8 | .579 | 10 | 268-714 | T5304-25 | 1/4 | .187 | 7 |
| 268-426 | 5100-75 | 3/4 | .693 | 8 | 268-716 | T5304-31 | 5/16 | .250 | 6 |
| 268-428 | 5100-87 | 7/8 | .810 | 7 | 268-718 | T5304-37 | 3/8 | .312 | 6 |
| 268-430 | 5100-100 | 1 | .925 | 6 | 268-722 | T5304-50 | 1/2 | .406 | 5 |
| 268-432 | 5100-112 | 1-1/8 | 1.041 | 5 | 268-724 | T5304-62 | 5/8 | .500 | 4 |
| 268-434 | 5100-125 | 1-1/4 | 1.156 | 4 | | | | | |

GARAGE ASSORTMENT

No. 020-040

Contains 60 Snap Rings, 9 sizes of 268-500 Series, for 1/8" to 1/2" Dia. shafts.

020-040



MASTER ASSORTMENT

No. 020-627

Contains 401 Snap Rings, 36 sizes. Priced label in lid has actual size ring outlines for easy identification. Metal box has moulded compartments. Has a complete stock of all ring sizes and types listed above. Size: 9-3/4" W x 13-3/4" L x 2" D.

020-817



'SUPER-SERVICE' ASSORTMENT

No. 020-817

Contains 705 Snap Rings - 50 sizes. Large size, rigid metal box with high-strength plastic compartments.

Size: 12" W x 18" L x 3" D.

For more details see page 10.

**SNAP RINGS
CIRCLIPS**

268
Series

Packaged in uniformly priced transparent packs.

*Example of Stock Number: 268-246

ORDER BY STOCK NUMBER

Illustrations Actual Size

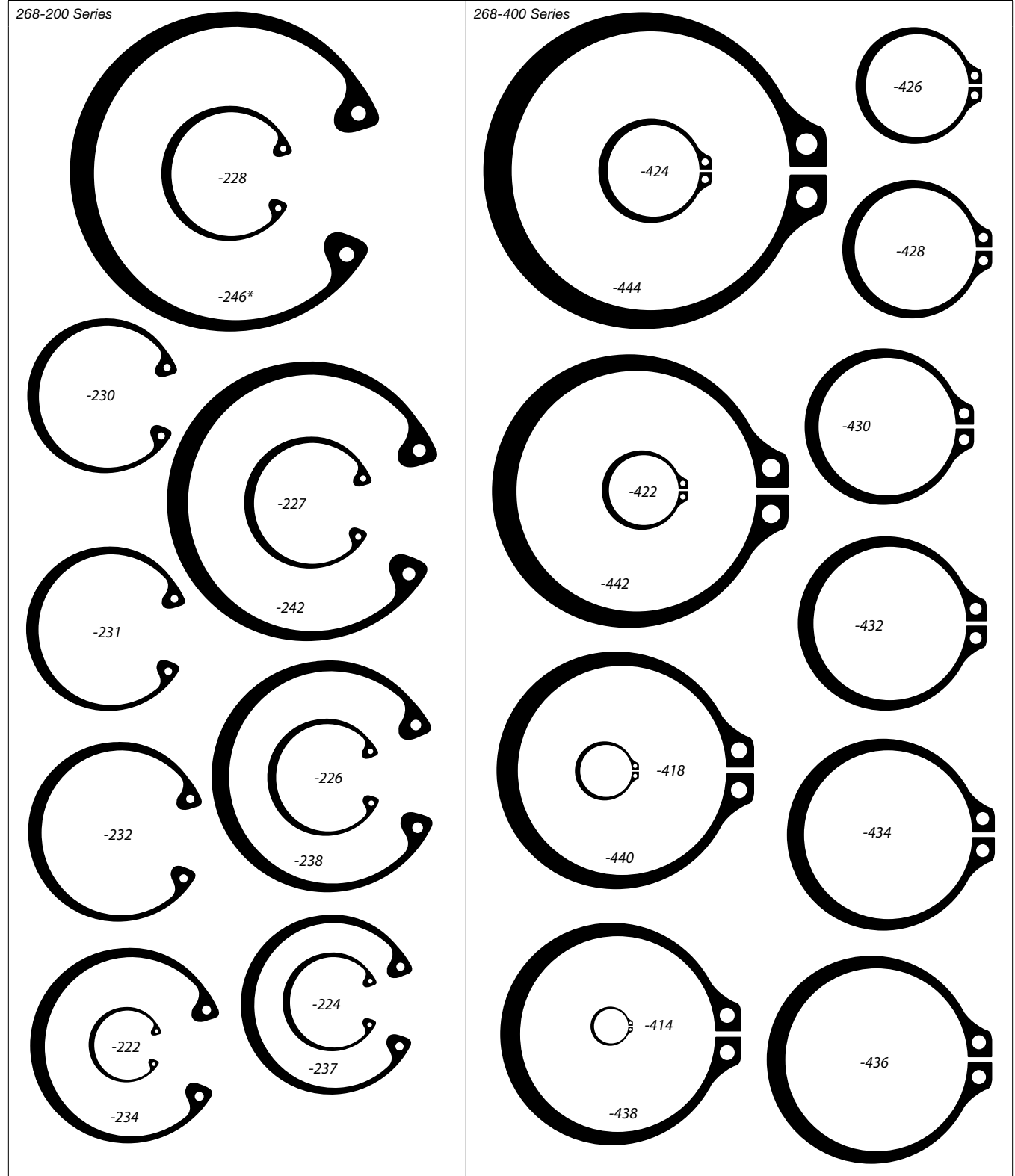





For Other sizes of Snap Rings - see next page.

**SNAP RINGS
CIRCLIPS**

**268
Series**

ORDER BY STOCK NUMBER

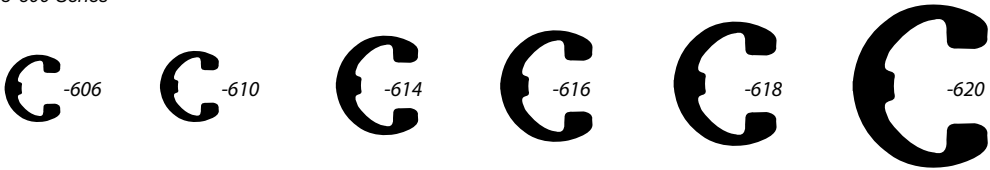
* Example of Stock Number: 268-522

| | |
|---|---|
| <p>268-300 Series</p>  <p>-329</p> | <p>268-500 Series</p>  <p>-505 -506 -511 -510 -514 -516 -518 -520 -522*</p> |
| <p>268-300 Series</p>  <p>-330</p> | <p>268-600 Series</p>  <p>-606 -610 -614 -616 -618 -620</p> |
| <p>268-300 Series</p>  <p>-332</p> | <p>268-700 Series</p>  <p>-714 -716 -718 -722 -724</p> |

GARAGE ASSORTMENT

No. 020-041

Contains 43 External Snap Rings, 6 sizes of 268-600 Series for 5/32" through 9/16" Dia. shafts.

No. 020-042

Contains 50 Internal Snap Rings, 10 sizes of 268-200 Series for 1/2" through 2" housing diameters.

020-041





**SNAP RING PLIERS
PINCES À CIRCLIP**

**262
Series**

ORDER BY STOCK NUMBER

Individually Carded

| | | | | | | | | | | | | | | | |
|---|--|--------|-------|-----|--|--------|----------------|--------|-------|-----|--------|----------------|--------|-------|-----|
|  | <p>No. 262-980 External with Tips (Black) No. 262-981 Internal with Tips (Red) No. 262-982 Snap Rings Pliers Set Economical tools for medium duty. Non-slip cushion coated grips on stamped Steel handles. Complete with four sets of tips.</p> | | | | | | | | | | | | | | |
|  | <p>No. 262-976 External with Tips (Black) No. 262-977 Internal with Tips (Red) Professional quality tools have no exposed springs to pop out or snag other tools. Non-slip cushion-coated handles make pliers easy to grip and use. Complete with four sets of tips.</p> | | | | | | | | | | | | | | |
|  | <p>No. 262-983 Precision Tips Set</p> <table border="1" data-bbox="591 1881 1429 1957"> <tr> <td>1 pair</td> <td>.045" Straight</td> <td>1 pair</td> <td>.035"</td> <td>45°</td> </tr> <tr> <td>1 pair</td> <td>.060" Straight</td> <td>1 pair</td> <td>.045"</td> <td>90°</td> </tr> </table> | | | | | 1 pair | .045" Straight | 1 pair | .035" | 45° | 1 pair | .060" Straight | 1 pair | .045" | 90° |
| 1 pair | .045" Straight | 1 pair | .035" | 45° | | | | | | | | | | | |
| 1 pair | .060" Straight | 1 pair | .045" | 90° | | | | | | | | | | | |

WOODRUFF KEYS CLAVETTES 'WOODRUFF'

302
Series

Papco[®] Woodruff Keys are made from S.A.E. 1035 Carbon Steel. They are used on armature shafts of starters and generators, etc.

ORDER BY STOCK NUMBER

| Stock No. | Size Width x Dia. | Stock No. | Size Width x Dia. | Stock No. | Size Width x Dia. | Stock No. | Size Width x Dia. |
|-----------|----------------------|-----------|----------------------|-----------|----------------------|-----------|----------------------|
| 302-010 | 1/16 x 1/2 | 302-091 | 1/4 x 3/4 | 302-170 | 7/32 x 1-1/8 | 302-236 | 3/8 x 1-3/8 |
| 302-020* | 3/32 x 1/2 | 302-100* | 5/32 x 7/8 | 302-180* | 1/4 x 1-1/8 | 302-240 | 1/4 x 1-1/2 |
| 302-030* | 1/8 x 1/2 | 302-110* | 3/16 x 7/8 | 302-183 | 5/16 x 1-1/8 | 302-250 | 5/16 x 1-1/2 |
| 302-040* | 3/32 x 5/8 | 302-120 | 7/32 x 7/8 | 302-190 | 3/16 x 1-1/4 | 302-257 | 3/8 x 1-1/2 |
| 302-050* | 1/8 x 5/8 | 302-121 | 1/4 x 7/8 | 302-200 | 7/32 x 1-1/4 | 302-270 | 1/4 x 2-1/8 |
| 302-060* | 5/32 x 5/8 | 302-130* | 3/16 x 1 | 302-210 | 1/4 x 1-1/4 | 302-280 | 5/16 x 2-1/8 |
| 302-061 | 3/16 x 5/8 | 302-140 | 7/32 x 1 | 302-214 | 5/16 x 1-1/4 | 302-290 | 3/8 x 2-1/8 |
| 302-070 | 1/8 x 3/4 | 302-150* | 1/4 x 1 | 302-215 | 3/8 x 1-1/4 | 302-291 | 3/8 x 2-3/4 |
| 302-080* | 5/32 x 3/4 | 302-152 | 5/16 x 1 | 302-220 | 1/4 x 1-3/8 | 302-292 | 5/16 x 2-3/4 |
| 302-090* | 3/16 x 3/4 | 302-160 | 3/16 x 1-1/8 | | | | |

Standard Package: 25 Keys



*Denotes popular sizes

Sizes not listed can be supplied.

GARAGE ASSORTMENT

No. 020-020

This assortment contains 100 Woodruff Keys in 12 sizes that are needed in every garage. Packed in a sturdy, plastic box.

020-020



GARAGE ASSORTMENT

No. 020-021

This assortment contains 29 of the following large size Woodruff Keys. 302-190, 200, 210, 214, 215, 220, 240, 250, 257, 270, 280, 290, 291, 292.

020-021



For complete coverage of most tractors and farm machinery use the 020-020 Woodruff Key Assortment together with 020-021.

MASTER ASSORTMENT

No. 020-614

- Contains 210 Woodruff Keys.
- 20 popular sizes.
- Metal merchandiser box with moulded plastic compartments.
- Actual size illustrations on lid label.
- Refills available in standard packages.
- Sizes: 302-010, 020, 030, 040, 050, 060, 070, 080, 090, 100, 110, 121, 130, 150, 152, 160, 180, 200, 210, 240.
- Size: 9-3/4" W x 13-3/4" L x 2" D.

020-614



'SUPER-SERVICE' ASSORTMENT

No. 020-820

Contains 374 Woodruff Keys - 32 sizes. Large size, rigid metal box with high-strength plastic compartments.

Size: 12" W x 18" L x 3" D.

For more details see page 10.

020-820



**UNIVERSAL 'O' - RINGS
JOINTS TORIQUES UNIVERSELS**

304 Series

Popular standard sizes used in automotive, agricultural and industrial equipment maintenance. Papco[®] O-Rings are made of a special Nitrile Compound (Buna-N Rubber) for petroleum oils, greases, automotive gasoline, alcohols, glycols, fuel oil, propane and many other fluids.

Assembly instructions: Be sure all parts are perfectly clean. Then lubricate the O-Ring. For an external groove, stretch the ring over the shaft or fold the ring into an internal groove. Avoid excessive twisting.

ORDER BY STOCK NUMBER **Standard Package: contains 25 'O' Rings**

| Stock No. | Nominal Size | | | Stock No. | Nominal Size | | |
|-----------|--------------|--------|---------|-----------|--------------|---------|---------|
| | I.D. | O.D. | Section | | I.D. | O.D. | Section |
| 304-001 | 1/8 | 1/4 | 1/16 | 304-022 | 1-3/16 | 1-7/16 | 1/8 |
| 304-002 | 5/32 | 9/32 | 1/16 | 304-023 | 1-1/4 | 1-1/2 | 1/8 |
| 304-003 | 3/16 | 5/16 | 1/16 | 304-024 | 1-5/16 | 1-9/16 | 1/8 |
| 304-004 | 7/32 | 11/32 | 1/16 | 304-025 | 1-3/8 | 1-5/8 | 1/8 |
| 304-005 | 1/4 | 3/8 | 1/16 | 304-026 | 1-7/16 | 1-11/16 | 1/8 |
| 304-006 | 5/16 | 7/16 | 1/16 | 304-027 | 1-1/2 | 1-3/4 | 1/8 |
| 304-007 | 3/8 | 1/2 | 1/16 | 304-028 | 1-1/2 | 1-7/8 | 3/16 |
| 304-008 | 3/8 | 9/16 | 3/32 | 304-029 | 1-5/8 | 2 | 3/16 |
| 304-009 | 7/16 | 5/8 | 3/32 | 304-030 | 1-3/4 | 2-1/8 | 3/16 |
| 304-010 | 1/2 | 11/16 | 3/32 | 304-031 | 1-7/8 | 2-1/4 | 3/16 |
| 304-011 | 9/16 | 3/4 | 3/32 | 304-033 | 2-1/8 | 2-1/2 | 3/16 |
| 304-012 | 5/8 | 13/16 | 3/32 | 304-035 | 2-3/8 | 2-3/4 | 3/16 |
| 304-013 | 11/16 | 7/8 | 3/32 | 304-037 | 2-5/8 | 3 | 3/16 |
| 304-014 | 3/4 | 15/16 | 3/32 | | | | |
| 304-015 | 3/4 | 1 | 1/8 | | | | |
| 304-016 | 13/16 | 1-1/16 | 1/8 | | | | |
| 304-017 | 7/8 | 1-1/8 | 1/8 | | | | |
| 304-018 | 15/16 | 1-3/16 | 1/8 | | | | |
| 304-019 | 1 | 1-1/4 | 1/8 | | | | |
| 304-020 | 1-1/16 | 1-5/16 | 1/8 | | | | |
| 304-021 | 1-1/8 | 1-3/8 | 1/8 | | | | |

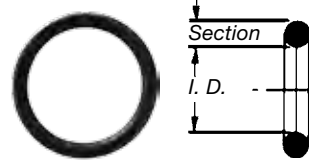

GARAGE ASSORTMENT

No. 020-072

Contains 78 rings, 15 sizes from 1/8" to 3/4" I.D. Packed in a clear plastic box.



UNIVERSAL 'O' RING ASSORTMENT

No. 020-960

Contains 382 rings, 30 sizes from 1/8" to 1-3/4" I.D. Popular assortment of inch-series. 'O' Rings packed in a durable A.B.S. plastic dispensing box with individual posts and compartments, and with a cross-section (thickness) molded gauge. Size chart is shown on cover.



MASTER ASSORTMENT

No. 020-626

Contains 300 rings, 30 sizes, in sturdy metal box with locking lid and carrying handle. Illustrated label with actual size illustrations to make correct selection easy.



'SUPER-SERVICE' ASSORTMENT

No. 020-821

Contains 390 'O' Rings - 30 sizes. Large size, rigid metal box with high-strength plastic compartments. Size: 12" W x 18" L x 3" D. For more details see page 10.

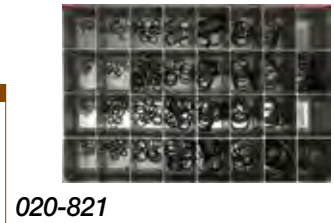

**AXLE SHAFT KEY STOCK
BARRES DE CLEF**

313 Series

Papco[®] Axle Key Stock in 12" lengths enables the technician to make up any size axle key on short notice and with a minimum investment. Standard package contains six 12" lengths.

ORDER BY STOCK NUMBER

| Stock No. | Size | Stock No. | Size |
|-----------|-------------|-----------|------------|
| 313-174 | 3/16 x 3/16 | 313-180 | 1/2 x 1/2 |
| 313-176 | 1/4 x 1/4 | 313-181 | 1/4 x 5/16 |
| 313-177 | 5/16 x 5/16 | 313-182 | 1/4 x 3/8 |
| 313-178 | 3/8 x 3/8 | 313-183 | 5/16 x 3/8 |
| 313-179 | 7/16 x 7/16 | 313-185 | 3/8 x 7/16 |

AXLE KEY STOCK ASSORTMENT

No. 020-853

Contains 20 Lengths of Key Stock in all popular sizes. All 12" Long.



ASSORTMENT

No. 020-906

This handy assortment contains 50 lengths - 10 each of 3/16", 1/4", 5/16", 3/8" and 1/2" sq. x 12" long Axle Key Stock. Make your own keys for axle shafts, pulley shafts and many other applications where a straight key is needed. Attractive, all metal merchandiser can stand on counter or hang on wall.

020-906



AXLE KEYS BARRES DE CLEF

313
Series

Papco[®] Axle Keys are made from special S.A.E. Key Steel, supplied in various sizes to service all cars and trucks.

ORDER BY STOCK NUMBER

Standard Package: Contains 12 Axle Keys

| Stock No. | Size | Stock No. | Size | Stock No. | Size | Straight Parallel Type |
|-----------|--------------------|-----------|---------------------|-----------|--------------------|------------------------|
| 313-078 | 3/16 x 3/16 x 1 | 313-115 | 1/4 x 5/16 x 3-1/4 | 313-139 | 1/4 x 3/8 x 3-1/4 | |
| 313-105 | 1/4 x 1/4 x 2-7/8 | 313-124 | 5/16 x 5/16 x 2-3/4 | 313-144 | 5/16 x 3/8 x 3-3/4 | |
| 313-107 | 1/4 x 1/4 x 3-1/8 | 313-127 | 5/16 x 5/16 x 3-1/8 | 313-147 | 5/16 x 7/16 x 3 | |
| 313-111 | 1/4 x 5/16 x 2-1/2 | 313-136 | 1/4 x 3/8 x 2-5/8 | 313-152 | 3/8 x 3/8 x 3-3/4 | |
| | | | | | | |

AXLE KEY ASSORTMENT

No. 020-862

This assortment contains 40 keys made up of the 12 sizes listed above.

020-862

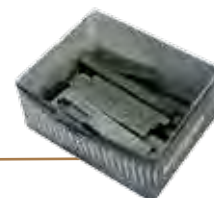

HOLE (BUTTON) PLUGS BOUCHONS DE TROU

314
Series



Used to plug holes in instrument panel, cowl, fire wall, etc. Made of Nickel Plated Steel with spring action prongs. They snap into place and can be removed and re-inserted.

ORDER BY STOCK NUMBER

Standard Package: 50 Plugs

| Stock No. | Fits Hole Size | Stock No. | Fits Hole Size |
|-----------|----------------|-----------|----------------|
| 314-018 | 3/8" | 314-026 | 3/4" |
| 314-020 | 7/16" | 314-030 | 1" |
| 314-022 | 1/2" | 314-034 | 1-1/4" |
| 314-024 | 5/8" | | |

For Plastic button Plugs: see page 154.

GARAGE ASSORTMENT

No. 020-028

Contains 47 hole plugs, including each of the sizes listed. Ideal for plugging aerial, accessory or switch holes. Packed in clear plastic container.

020-028



MECHANICS' WIRE BROCHE DE MÉCANICIEN

314
Series

STOVE PIPE WIRE

Papco[®] Mechanics Wire is soft annealed for general use in garage or workshop. Used as locking wire in drilled bolts in bearings and flywheels. Packed on sturdy plastic spools - saves time - eliminates waste.

ORDER BY STOCK NUMBER

| Stock No. | Two Pound Spools |
|-----------|---------------------------------|
| 314-218 | 18 Ga. (.047) 330 ft. Per spool |

Note: Length shown is approximate.

314-218



NOTES

Multiple horizontal lines for taking notes.

AN INTRODUCTION TO...

WHEEL PARTS

PIÈCES DE ROUE

...UNE INTRODUCTION.

www.hpaulin.com

For a full listing of Papco®
Wheel Parts and application
guide, please refer to our current
catalogue or visit our website to
download a PDF version.



WHEEL BOLTS AND NUTS

- PASSENGER CAR
- LIGHT TRUCK
- IMPERIAL
- METRIC
- HEAVY TRUCK

REAR WHEEL STUDS



**WHEEL NUTS
ÉCROUS DE ROUE**

**558
Series**

PASSENGER CAR/LIGHT TRUCK

**559
Series**

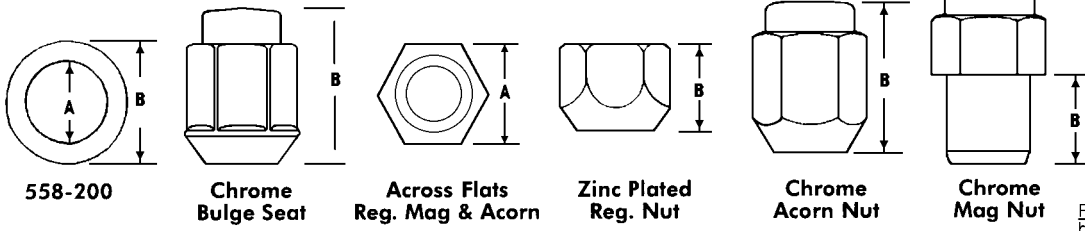

REFER TO CURRENT WHEEL PARTS CATALOGUE FOR FULL LISTING AND APPLICATION GUIDE

| Part No | Diameter/Type | 'A' | 'B' | Type | St. Pkg. | Part No | Diameter/Type | 'A' | 'B' | Type | St. Pkg. |
|---------|--------------------------|--------|---------|------|----------|---------|---------------------------|-------|--------|------|----------|
| 558-014 | 7/16-20R Reg. | 3/4 | 9/16 | Sz | 25 | 559-089 | M12 x 1.5 Flattop Capped | 19mm | 32mm | Fs | 10 |
| 558-016 | 1/2-20R Reg. | 13/16 | 5/8 | Sz | 25 | 559-095 | M12 x 1.25 Mag | 13/16 | 3/4 | Mc | 10 |
| 558-027 | 1/2-20R Reg. | 3/4 | 9/16 | Sz | 25 | 559-100 | M12 x 1.5 Mag | 13/16 | 3/4 | Mc | 10 |
| 558-044 | 5/8-18R Reg. | 1-1/16 | 21/32 | Sz | 10 | 559-112 | M14R x 1.5 | 21mm | 34mm | D | 10 |
| 558-045 | 5/8-18L Reg. | 1-1/16 | 21/32 | Sz | 10 | 559-113 | M12 x 1.25 Standard | 21mm | 16mm | Sc | 10 |
| 558-047 | 9/16-18R Reg. | 1 | 11/16 | Sz | 10 | 559-114 | M12 x 1.25 Acorn | 21mm | 29mm | Ac | 10 |
| 558-050 | 9/16-18L Reg. | 1 | 11/16 | Sz | 10 | 559-117 | M12 x 1.5 Flanged Flat | 21mm | 37mm | DHc | 10 |
| 558-055 | 5/8-18R Reg. | 1 | 21/32 | Sz | 10 | 559-125 | M12 x 1.25 Reg. | 21mm | 16mm | Sz | 10 |
| 558-057 | 5/8-18R Flange | 1-1/8 | 1-1/16 | Hs | 10 | 559-137 | M12 x 1.5 Acorn Flanged | 19mm | 40mm | AHc | 10 |
| 558-058 | 9/16-18R Reg. | 1-1/16 | 21/32 | Sz | 10 | 559-138 | M12 x 1.5 Acorn Flanged | 19mm | 35mm | AHc | 10 |
| 558-061 | 9/16-18R Reg. | 1-1/16 | 15/16 | Sz | 10 | 559-141 | M12 x 1.5 Acorn | 21mm | 27mm | Ac | 10 |
| 558-062 | 9/16-R Bulge | 15/16 | 1-1/64 | Bz | 10 | 559-150 | M12 x 1.5 Reg. | 19mm | 14mm | Sz | 10 |
| 558-070 | 7/16-20 Dometop Capped | 3/4 | 1-1/8 | Ds | 10 | 559-151 | M12 x 1.5 External Thread | 19mm | 34mm | EHs | 10 |
| 558-071 | 1/2-20 Dometop Capped | 13/16 | 1-15/32 | Ds | 10 | 559-154 | M14 x 1.5 Bulge | 22mm | 21mm | Bz | 10 |
| 558-092 | 9/16-18R Wash. Nut | 1-1/16 | 1 | Hb | 10 | 559-163 | M12 x 1.5 Bulge | 19mm | 23mm | Bz | 10 |
| 558-094 | 1/2-20 Dometop Bulge | 3/4 | 1-39/64 | DBs | 10 | 559-167 | M12-1.5 Mag | 21mm | 47mm | Mc | 10 |
| 558-100 | 9/16-18R Reg. | 7/8 | 3/4 | Sz | 10 | 559-172 | M12 x 1.5 Reg. | 21mm | 18mm | Sz | 10 |
| 558-122 | 1/2-20 Dometop Capped | 3/4 | 1-5/16 | Ds | 10 | 559-174 | M12 x 1.75 Flanged Flat | 19mm | 23mm | Hb | 10 |
| 558-123 | 1/2-20 Dometop Capped | 13/16 | 1-17/64 | Db | 10 | 559-181 | M12 x 1.5 Wirewheel | 19mm | 43mm | Ws | 10 |
| 558-124 | 1/2-20 Dometop Bulge | 13/16 | 1-9/32 | DBs | 10 | 559-190 | M12 x 1.5 Dometop Capped | 19mm | 36mm | Ds | 5 |
| 558-127 | 9/16-18 Flanged Flat | 7/8 | 1 | Hb | 10 | 559-191 | M12 x 1.5 External Thread | 19mm | 28mm | Ez | 5 |
| 558-140 | 7/16-20 Acorn | 3/4 | 1-3/8 | Ac | 10 | 559-192 | M12 x 1.5 External Thread | 19mm | 31mm | Ez | 5 |
| 558-143 | 1/2-20 Dometop Capped | 13/16 | 2-1/32 | Ds | 10 | 559-193 | M14 x 1.5 External Thread | 22mm | 29mm | Ez | 5 |
| 558-144 | 7/16-20 Acorn | 13/16 | 1-3/8 | Ac | 10 | 559-194 | M14 x 1.5 External Thread | 22mm | 26mm | Ez | 5 |
| 558-146 | 1/2-20 Acorn | 13/16 | 1-3/8 | Ac | 10 | 559-196 | M14 x 2.0 Flanged Flat | 21mm | 23mm | Hb | 10 |
| 558-148 | 1/2-20R Acorn Bulge | 3/4 | 1-3/8 | ABc | 10 | 559-200 | M24 x 2.0 Cover Grey | 18mm | 29mm | Cg | 5 |
| 558-160 | 1/2-20 External Thread | 3/4 | 1-3/16 | Ez | 5 | 559-201 | M24 x 2.0 Cover Stainless | 19mm | 39mm | Cs | 5 |
| 558-162 | 1/2-20 Bulge | 13/16 | 59/64 | Bz | 5 | 559-202 | M24 x 2.0 Cover Black | 19mm | 40mm | Cb | 5 |
| 558-163 | 1/2-20 Bulge | 3/4 | 29/32 | Bz | 10 | 559-203 | M24 x 2.0 Cover Grey | 19mm | 44mm | Cg | 5 |
| 558-171 | 1/2-20 Wirewheel | 3/4 | 1-1/4 | Wz | 10 | 559-204 | M24 x 2.0 Cover Black | 19mm | 45mm | Cb | 5 |
| 558-174 | 7/16-20 Mag | 13/16 | 3/4 | Mc | 10 | 559-205 | M27 x 2.0 Cover Black | 22mm | 40mm | Cb | 5 |
| 558-176 | 1/2-20 Mag | 13/16 | 3/4 | Mc | 10 | 559-206 | M27 x 2.0 Cover Black | 23mm | 40mm | Cg | 5 |
| 558-197 | 1/2-20 Wirewheel | 13/16 | 1-5/32 | Wz | 10 | 559-209 | M24 x 2.0 Cover Black | 18mm | 29mm | Cb | 5 |
| 558-199 | 1/2-20R Wirewheel | 3/4 | 1-1/4 | Wz | 10 | 559-210 | M27 x 2.0 Cover Black | 21mm | 39mm | Cg | 5 |
| 558-200 | Mag Washers | 11/16 | 1 | c | 10 | 559-211 | M24 x 2.0 Cover Grey | 19mm | 33mm | Cg | 5 |
| 558-204 | 9/16-18 Dometop Bulge | 7/8 | 1-1/2 | DBc | 10 | 559-212 | M27 x 2.0 Cover Black | 22mm | 36mm | Cb | 5 |
| 558-222 | 1/2-20 External Thread | 13/16 | 1.07 | Sz | 5 | 559-215 | M24 x 2.0 Cover Black | 19mm | 33mm | Cb | 5 |
| 558-292 | 1/2-20 Dometop Capped | 13/16 | 1-1/2 | Ds | 10 | 559-220 | M24 x 2.0 Cover Black | 19mm | 33mm | Cb | 5 |
| 558-296 | 9/16-18 Flanged Flat | 15/16 | 1-1/8 | Hb | 10 | 559-257 | M14-1.5 Bulge | 21mm | 24mm | Bz | 10 |
| 559-060 | M10 x 1.25 Acorn | 17mm | 21mm | Ac | 10 | 559-259 | M14-1.5 Dometop Capped | 21mm | 43.5mm | Dc | 10 |
| 559-064 | M12 x 1.25 Reg. | 19mm | 16mm | Sc | 10 | 559-277 | M14-1.5 Acorn | 22mm | 46mm | Ac | 10 |
| 559-065 | M12 x 1.25 Acorn | 13/16 | 1-3/8 | Ac | 10 | 559-301 | M12 x 1.5 Acorn Bulge | 19mm | 30mm | ABc | 10 |
| 559-070 | M12 x 1.5 Acorn | 13/16 | 1-3/8 | Ac | 10 | 559-302 | M14-1.5 Flanged Flat | 22mm | 34mm | Hb | 10 |
| 559-074 | M12 x 1.5 Dometop Capped | 19mm | 31mm | Ds | 10 | 559-305 | M12 x 1.5 Dometop Capped | 20mm | 30mm | Ds | 10 |
| 559-075 | M12 x 1.5 Acorn | 3/4 | 1-3/8 | Ac | 10 | 559-306 | M14 x 2.0 Dometop Capped | 20mm | 50mm | Ds | 10 |
| 559-077 | M12 x 1.5 Acorn Bulge | 19mm | 35mm | ABc | 10 | 559-308 | M12 x 1.5 Acorn | 21mm | 38mm | Ac | 10 |
| 559-078 | M12 x 1.25 Acorn | 19mm | 25mm | Ac | 10 | 559-309 | M12 x 1.5 Acorn | 21mm | 30mm | Ac | 10 |
| 559-085 | M12 x 1.5 Wirewheel | 19mm | 22mm | Wb | 10 | 559-310 | M12 x 1.25 Dometop Capped | 21mm | 34mm | Dc | 10 |
| 559-087 | M12 x 1.5 Dometop Capped | 19mm | 30mm | Ds | 10 | 559-323 | M14 x 2.0 Wire Wheel | 21mm | 31mm | Ws | 10 |

WHEEL BOLTS BOULONS DE ROUE

560 Series

PASSENGER CAR/LIGHT TRUCK

■ Bare Metal

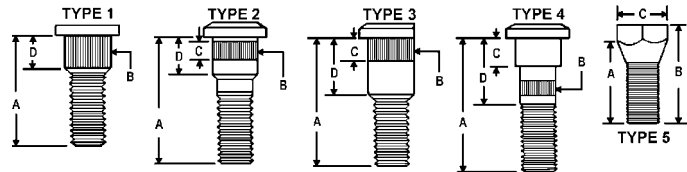

■ REFER TO CURRENT WHEEL PARTS CATALOGUE FOR FULL LISTING AND APPLICATION GUIDE

Specifications and Interchange

Standard Package 10 pcs.

| Part No. | Type | Diameter x 'A' | | 'B' | 'C' | 'D' | Factory No. |
|----------|------|----------------|-------------|---------|---------|-------|--------------|
| 560-009 | 5 | 1/2-20 | R x 7/8 | 1-1/4 | 3/4 HEX | - | - |
| 560-010 | 5 | 1/2-20 | R x 1-1/8 | 1-1/2 | 3/4 HEX | - | - |
| 560-011 | 5 | 1/2-20 | R x 1-7/8 | 2-1/4 | 3/4 HEX | - | - |
| 560-013 | 5 | 9/16-18 | R x 1-7/16 | 1-13/16 | 7/8 HEX | - | - |
| 560-014 | 5 | 9/16-18 | R x 1-5/16 | 1-11/16 | 7/8 HEX | - | - |
| 560-015 | 5 | 9/16-18 | R x 1-5/8 | 2-1/16 | 7/8 HEX | - | - |
| 560-016 | 5 | 9/16-18 | R x 1-3/8 | 1-3/4 | 3/4 HEX | - | - |
| 560-017 | 5 | 5/8-18 | R x 1-9/16 | 2 | 7/8 HEX | - | - |
| 560-018 | 5 | 1/2-20 | R x 1-1/8 | 1-7/16 | 3/4 HEX | - | - |
| 560-019 | 5 | 9/16-18 | R x 1-1/4 | 1-9/16 | 3/4 HEX | - | - |
| 560-032 | 1 | 1/2-20 | R x 1-3/8 | .630 | - | .555 | 2405146 |
| 560-034 | 1 | 1/2-20 | R x 1-1/2 | .618 | - | .312 | 1486230 |
| 560-039 | 2 | 1/2-20 | R x 1-5/8 | .620 | .460 | .500 | 2952858 |
| 560-090 | 2 | 1/2-20 | R x 1-5/16 | .625 | .270 | .438 | 539499 |
| 560-096 | 1 | 7/16-20 | R x 1-7/16 | .560 | - | .530 | 2534754 |
| 560-102 | 2 | 1/2-20 | R x 1-11/16 | .562 | .200 | .630 | 3229187 |
| 560-103 | 2 | 1/2-20 | R x 1-1/2 | .665 | .200 | .590 | 2513744 |
| 560-105 | 2 | 1/2-20 | R x 1-13/16 | .560 | .300 | .640 | 3699680 |
| 560-110 | 4 | 1/2-20 | R x 2 | .623 | .215 | 1.000 | 3736751 |
| 560-114 | 2 | 7/16-20 | R x 1-1/2 | .465 | .140 | .285 | 9590259/71 |
| 560-138 | 1 | 1/2-20 | R x 1-5/8 | .535 | - | .325 | 1235137 |
| 560-148 | 2 | 1/2-20 | R x 1-13/16 | .620 | .220 | .780 | 3580693 |
| 560-155 | 1 | 1/2-20 | R x 1-5/8 | .630 | - | .620 | 3961258 |
| 560-163 | 2 | 1/2-20 | R x 1-7/16 | .545 | .270 | .438 | D3AZ-1107B |
| 560-167 | 2 | 1/2-20 | R x 1-15/16 | .587 | .220 | .625 | D6AZ-1107C |
| 560-172 | 2 | 1/2-20 | R x 1-7/8 | .560 | .300 | .650 | D6DZ-1107A |
| 560-173 | 2 | 1/2-20 | R x 1-3/4 | .625 | .280 | .438 | D6AZ-1107A |
| 560-175 | 2 | 1/2-20 | R x 1-3/4 | .665 | .312 | .575 | 2959852 |
| 560-180 | 4 | 5/8-18 | R x 2-1/16 | .655 | .312 | .906 | 3496564 |
| 560-181 | 2 | 5/8-18 | R x 2-13/32 | .652 | .255 | .813 | 3641576 |
| 560-182 | 4 | 5/8-18 | R x 2-9/16 | .655 | .400 | .875 | 2515316 |
| 560-183 | 4 | 5/8-18 | R x 2-15/16 | .650 | .420 | 1.000 | 3637878 |
| 560-186 | 2 | 1/2-20 | R x 1-7/8 | .612 | .250 | .600 | EOTZ-1107C |
| 560-187 | 1 | 1/2-20 | R x 1-5/8 | .623 | - | .650 | 5357196 |
| 560-269 | 2 | 1/2-20 | R x 2-1/8 | .623 | .200 | .600 | D3TZ-1107A/E |
| 560-277 | 4 | 1/2-20 | R x 2-1/4 | .625 | .225 | .965 | - |
| 560-280 | 4 | 9/16-18 | R x 2-1/8 | .625 | .225 | .935 | - |
| 560-286 | 4 | 1/2-20 | R x 2-3/16 | .723 | .300 | 1.250 | 4116934 |
| 560-287 | 2 | 1/2-20 | R x 1-29/32 | .667 | .375 | .725 | 6032505 |
| 560-289 | 2 | 1/2-20 | R x 1-29/32 | .583 | .325 | .420 | 6033382 |
| 560-298 | 2 | 1/2-20 | R x 2 | .547 | .215 | .687 | E6TZ-1107B |
| 560-303 | 2 | 9/16-18 | R x 3-9/32 | .677 | .435 | .725 | E5TZ-1107B |
| 560-305 | 2 | 9/16-18 | R x 2-1/8 | .640 | .275 | .562 | E6TZ-1107A |
| 560-345 | 2 | 1/2-20 | R x 1-7/8 | .570 | .225 | .625 | - |
| 560-348 | 4 | 1/2-20 | R x 2-1/8 | .658 | - | .812 | 4383430 |
| 560-355 | 4 | 9/16-18 | R x 2-13/16 | .630 | .180 | 1.125 | D0TZ-1107A |
| 560-356 | 4 | 9/16-18 | L x 2-13/16 | .630 | .225 | 1.125 | D0TZ-1119A |
| 560-358 | 2 | 1/2-20 | R x 2 | .612 | .340 | .656 | E9ZZ-1107A |
| 560-363 | 4 | 1/2-20 | R x 2-11/32 | .651 | .415 | 1.000 | 4030779 |
| 560-364 | 2 | 1/2-20 | R x 1-15/32 | .618 | .210 | .484 | 83503053 |
| 560-366 | 2 | 1/2-20 | R x 1-3/4 | .650 | .370 | .740 | 1229808-9 |
| 560-367 | 3 | 1/2-20 | R x 2 | .585 | .190 | .750 | F1VZY-1107A |
| 560-368 | 2 | 1/2-20 | R x 1-31/32 | .615 | .312 | .531 | F0VY-1107A |
| 560-376 | 2 | 9/16-18 | R x 1-7/8 | .620 | .312 | .700 | 3997956 |
| 560-386 | 2 | 7/16-20 | R x 1-5/16 | .555 | .280 | .400 | 9590258 |
| 560-389 | 2 | 9/16-18 | R x 2-5/16 | .666 | - | .812 | - |
| 560-390 | 2 | 7/16-20 | R x 1-1/2 | .555 | .300 | .650 | 99785156 |
| 560-439 | 2 | 9/16-18 | R x 2-7/16 | .658 | .270 | .438 | - |
| 560-444 | 3 | 1/2-20 | R x 2-1/16 | .628 | .188 | .437 | - |
| 560-458 | 4 | 9/16-18 | R x 2-13/32 | .630 | .325 | .950 | C9TZ-1107C |
| 560-459 | 2 | 9/16-18 | R x 2-1/8 | .635 | .280 | .500 | 334388 |
| 560-460 | 2 | 9/16-18 | R x 3 | .630 | .875 | 1.060 | 3988538 |
| 560-461 | 2 | 9/16-18 | R x 3-9/16 | .630 | .875 | 1.675 | 355815 |
| 560-468 | 4 | 9/16-18 | R x 2-1/8 | .650 | .300 | .750 | 475988 |
| 560-469 | 4 | 9/16-18 | R x 2-1/2 | .650 | .410 | .925 | 14002236 |
| 560-470 | 4 | 1/2-20 | R x 1-3/4 | .625 | .200 | .740 | 2955940 |
| 560-472 | 2 | 9/16-18 | R x 2 | .623 | .200 | .585 | C8TZ-1170E |
| 560-473 | 4 | 9/16-18 | R x 2-5/8 | .622 | .225 | 1.000 | E0TZ-1107B |
| 560-474 | 2 | 9/16-18 | R x 2-1/2 | .620 | .240 | .500 | E4TZ-1107A |
| 560-479 | 3 | 1/2-20 | R x 2-3/32 | .610 | .312 | .484 | - |
| 560-529 | 2 | 9/16-18 | R x 2-3/8 | .645 | .300 | .425 | 2C2Z1107A |
| 560-604 | 4 | 7/16-20 | R x 1-3/4 | .575 | .280 | .860 | 3995841 |

**METRIC WHEEL BOLTS
BOULONS DE ROUE MÉTRIQUE**

**561
Series**

PASSENGER CAR/LIGHT TRUCK

■ Bare Metal

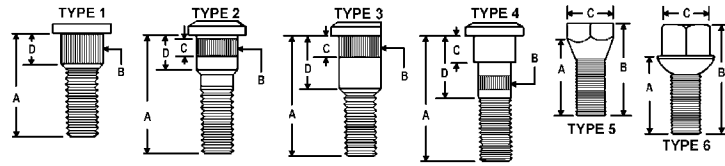

■ REFER TO CURRENT WHEEL PARTS CATALOGUE FOR FULL LISTING AND APPLICATION GUIDE

Specifications and Interchange

Standard Package 10 pcs.

| Part No. | Type | Diameter x 'A' | 'B' | 'C' | 'D' | Factory No. |
|----------|------|---------------------|---------|----------|---------|---------------------|
| 561-100 | 2 | M12 x 1.25R x 39mm | 12.9mm | 7mm | 15.4mm | 40222-A0800 |
| 561-102 | 2 | M12 x 1.25R x 32mm | 12.9mm | 7mm | 10.6mm | 40222-2201 |
| 561-106 | 1 | M12 x 1.5R x 38.5mm | 14.7mm | - | 10mm | 6500352/073 |
| 561-108 | 2 | M12 x 1.5R x 38.5mm | 14.3mm | 7mm | 10mm | 5204272 |
| 561-109 | 3 | M12 x 1.5R x 40mm | 14.8mm | 7mm | 13.5mm | - |
| 561-110 | 2 | M12 x 1.5R x 43mm | 13mm | 6mm | 9.6mm | 9590475/76 |
| 561-112 | 2 | M12 x 1.5R x 40mm | 12.5mm | 8mm | 10mm | 94024217 |
| 561-114 | 1 | M12 x 1.5R x 38mm | 14.35mm | - | 11mm | 94025172 |
| 561-115 | 2 | M12 x 1.5R x 35mm | 12.7mm | 5mm | 9mm | - |
| 561-118 | 5 | M12 x 1.5R x 34mm | 43mm | 19mm Hex | - | 3238138, D8RZ-1107B |
| 561-122 | 1 | M12 x 1.5R x 36mm | 14.3mm | - | 9mm | 90942-02035 |
| 561-126 | 2 | M12 x 1.5R x 41mm | 14.2mm | 5mm | 8.5mm | 90942-02037 |
| 561-130 | 6 | M12 x 1.5R x 27mm | 40mm | 17mm Hex | - | 321-601-139 |
| 561-132 | 6 | M12 x 1.5R x 30mm | 45mm | 17mm Hex | - | 321-601-139C |
| 561-133 | 6 | M14 x 1.5R x 35mm | 50mm | 17mm Hex | - | 431/443-601-139A |
| 561-139 | 2 | M12 x 1.5R x 37mm | 14mm | 4mm | 11mm | - |
| 561-140 | 1 | M12 x 1.5R x 37mm | 14.4mm | - | 6.4mm | MB057603 |
| 561-152 | 6 | M12 x 1.5R x 30mm | 48mm | 19mm Hex | - | 90304-692-920-921 |
| 561-154 | 2 | M12 x 1.5R x 36mm | 12mm | 6.3mm | 12mm | 90113-SAO-003 |
| 561-155 | 1 | M12 x 1.25R x 33mm | 12mm | - | 10mm | 90113-634-003 |
| 561-166 | 1 | M12 x 1.5R x 32mm | 13mm | - | 9mm | D5RY-1107C |
| 561-167 | 6 | M12 x 1.5R x 28mm | 44mm | 21mm Hex | - | - |
| 561-168 | 2 | M12 x 1.5R x 38mm | 13mm | 7mm | 12mm | E07Z-1107A/C |
| 561-169 | 2 | M12 x 1.5R x 43mm | 12.85mm | 6.5mm | 13.8mm | F0CZ-1107A |
| 561-174 | 1 | M12 x 1.25R x 34mm | 12.24mm | - | 10mm | 96057612 |
| 561-175 | 2 | M12 x 1.25R x 38mm | 12.24mm | 9.6mm | 14mm | 96057613 |
| 561-247 | 2 | M12 x 1.5R x 46mm | 13.41mm | 6.5mm | 11.2mm | F0DZ-1107A |
| 561-248 | 2 | M12 x 1.5R x 43mm | 14.5mm | 5.5mm | 11mm | E43Z-1107A |
| 561-249 | 2 | M12 x 1.5R x 46mm | 15.37mm | 5.7mm | 15mm | E9SZ-1107C |
| 561-250 | 3 | M12 x 1.5R x 47mm | 13.34mm | 6.5mm | 14.3mm | E0SZ-1107A |
| 561-251 | 2 | M12 x 1.5R x 51mm | 13.5mm | 5mm | 14.5mm | E3FZ-1107A |
| 561-255 | 2 | M12 x 1.5R x 52mm | 12.9mm | 13mm | 26.5mm | FB05-26-113A |
| 561-264 | 4 | M12 x 1.5R x 52mm | 14.33mm | 5.5mm | 25.12mm | 90942-02053/044 |
| 561-309 | 3 | M12 x 1.5R x 42.7mm | 13.08mm | 7mm | 19.5mm | 8596-33-062 |
| 561-312 | 2 | M12 x 1.5R x 44mm | 14.17mm | 7mm | 12mm | MB584750 |
| 561-322 | 1 | M12 x 1.25R x 30mm | 14.27mm | - | 6.10mm | - |
| 561-361 | 3 | M12 x 1.5R x 41mm | 16.50mm | 5mm | 13.3mm | 6501268, 6501512 |
| 561-367 | 6 | M12 x 1.5R x 36mm | 52mm | 17mm Hex | - | - |
| 561-369 | 2 | M12 x 1.5R x 46mm | 15.00mm | 6.6mm | 18.00mm | 6502311 |
| 561-370 | 2 | M12 x 1.5R x 44mm | 15.80mm | 6mm | 15.2mm | 6502247 |
| 561-371 | 2 | M12 x 1.5R x 43mm | 17.00mm | 6mm | 15.00mm | 6502330 |
| 561-376 | 3 | M12 x 1.5R x 49mm | 13.90mm | 7.7mm | 15.00mm | F3DZ-1107A |
| 561-378 | 2 | M12 x 1.25R x 42mm | 14.35mm | 7mm | 13.5mm | - |
| 561-380 | 2 | M10 x 1.25R x 29mm | 10mm | 6mm | 9mm | 96055156 |
| 561-390 | 1 | M12 x 1.75R x 51mm | 14.73mm | - | 8mm | - |
| 561-393 | 2 | M12 x 1.75R x 55mm | 14.73mm | 6mm | 18mm | - |
| 561-401 | 2 | M12 x 1.25R x 42mm | 14.43mm | 6mm | 14.5mm | - |
| 561-410 | 2 | M14 x 1.5R x 49mm | 15.7mm | 8mm | 14.5mm | 12338057 |
| 561-411 | 2 | M14 x 1.5R x 76mm | 15.7mm | 23mm | 27mm | 15545356 |
| 561-413 | 2 | M14 x 1.5R x 43mm | 15.7mm | 8.5mm | 6mm | 12338040 |
| 561-414 | 2 | M14 x 1.5R x 43mm | 15.7mm | 8mm | 16.5mm | 15589423 |
| 561-415 | 2 | M14 x 1.5R x 46mm | 15.8mm | 7mm | 14mm | 15589455 |
| 561-416 | 2 | M12 x 1.5R x 52mm | 14.8mm | 8mm | 15.3mm | - |
| 561-417 | 4 | M14 x 1.5R x 54mm | 15.7mm | 7mm | 19mm | 15589486 |
| 561-418 | 2 | M14 x 1.5R x 91mm | 15.7mm | 22mm | 33mm | 15589493 |
| 561-424 | 2 | M14 x 2.0R x 73mm | 15.78mm | 8mm | 14.25mm | - |
| 561-428 | 2 | M14 x 1.5R x 65mm | 15.7mm | 7mm | 17mm | - |
| 561-431 | 2 | M14 x 1.5R x 80mm | 15.67mm | 19mm | 35mm | - |
| 561-434 | 2 | M14 x 1.5R x 58mm | 16mm | 6mm | 18mm | - |
| 561-436 | 2 | M14 x 1.5R x 104mm | 16mm | 30mm | 59mm | - |
| 561-442 | 2 | M14 x 2.0R x 58mm | 15.5mm | 4.6mm | 12mm | - |
| 561-445 | 1 | M12 x 1.5R x 49mm | 14.48mm | - | 7mm | - |
| 561-467 | 6 | M14 x 1.5R x 36mm | 50.5mm | 17mm Hex | - | 4D0601139A |
| 561-492 | 2 | M12 x 1.5R x 48.3mm | 12.84mm | 5.5mm | 7mm | 22701519 |
| 561-502 | 3 | M14 x 1.5R x 50mm | 16.02mm | - | 18mm | - |
| 561-516 | 6 | M14 x 1.5R x 36mm | 49mm | 17mm Hex | - | 0009904907 |
| 561-522 | 6 | M14 x 1.5R x 41mm | 54.5mm | 17mm Hex | - | 36136758730 |
| 561-527 | 1 | M14 x 1.5R x 45.5mm | 16.5mm | - | 9mm | 90113-SHJ-A01 |
| 561-532 | 6 | M14 x 1.25R x 36mm | 49mm | 17mm Hex | - | 36136774896 |

WHEEL NUTS ÉCROUS DE ROUE

558
Series

HEAVY TRUCK

■ Plated



062-526
062-524

558-028
558-029

558-034
558-035

558-032
558-033

Standard Package 10 pcs.

| Part No. | Type | Size and Thread | Factory No. | Budd No. |
|----------|-----------------|---------------------------------------|-----------------|----------|
| 062-526 | Hex Conelok 'B' | 3/4-16 Right Hand; 1-1/8 Hex. | Back Nut (H.T.) | |
| 062-524 | Hex Conelok 'B' | 5/8-18 Right Hand; 1-15/16 Hex. | Back Nut (H.T.) | |
| 558-028 | Hex Bevelled | 3/4-16 Right Hand; 1-1/2 Hex. | BB1120, 3729738 | 37888 |
| 558-029 | Hex Bevelled | 3/4-16 Left Hand; 1-1/2 Hex. | BB1121, 3729737 | 37889 |
| 558-032 | In. & Out. Thd. | 3/4-16 Right Hand 1-1/8-16 Right Hand | BB1132, 279672 | 10708 |
| 558-033 | Same as above | 3/4-16 Left Hand 1-1/8-16 Left Hand | BB1133, 279673 | 10709 |
| 558-034 | Hex Bevelled | 1-1/8-16 Right Hand; 1-1/2 Hex. | BB1134, 279670 | 37891-E |
| 558-035 | Hex Bevelled | 1-1/8-16 Left Hand; 1-1/2 Hex. | BB1135, 279671 | 37892-E |

REAR WHEEL STUDS GOUJONS DE ROUE ARRIÈRE

565
Series

■ Plated



Standard and Oversize

| Stock No. | Description Thread x Thread x Length | Thread Length | Application |
|-----------|---|--------------------|---|
| 565-170 | 7/16-20 x 7/16-14 x 2 | 7/8 UNF 3/4 UNC | 598766, Dodge |
| 565-180 | 7/16-20 x 7/16-14 x 2 1/2 | 7/8 UNF 3/4 UNC | , Dodge |
| 565-181 | 7/16-20 x 9/16-12 x 2 1/2 | 7/8 UNF 7/8 UNC | No. 2023789, Oversize GMC Truck |
| 565-191 | 7/16-20 x 1/2-13 x 1 3/4 | 1 UNF 1/2 UNC | No. 352728-X Oversize |
| 565-200 | 7/16-20 x 7/16-14 x 2 1/4 | 7/8 UNF 7/8 UNC | No. 3651377 Chevy Truck 1940-53 |
| 565-201 | 7/16-20 x 1/2-13 x 2 1/4 | 7/8 UNF 7/8 UNC | No. 3651377-X Oversize |
| 565-210 | 5/8-11 x 5/8-11 x 2 3/4 | 1 1/2 UNC 1 UNC | Universal Truck Stud, Dayton Wheels |
| 565-240 | 1/2-20 x 1/2-13 x 2 1/2 | 1UNF 3/4 UNC | 55564H International |
| 565-250 | 1/2-20 x 9/16-12 x 2 3/8 | 7/8 UNF 7/8 UNC | No. 10375VA, Oversize International |
| 565-270 | 1/2-20 x 1/2-13 x 2 7/8 | 7/8 UNF 3/4 UNC | No. 5846703 GM Mack 18AX405 Models B-60, B-61, M-35 |
| 565-337 | 3/4-10 x 3/4-10 x 2 13/16 | 1 1/2 UNC 1 UNC | Universal Truck Stud. Dayton Wheels |
| 565-487 | 7/16-20 x 11/16 x 7/16 | Hex Nut | No. 351025, use with both 565-190 & 565-191 Studs |
| 565-488 | 5/8-11 x 1 1/16 x 39/64 | Hex Nut | Use with 565-210 Stud |
| 565-489 | 3/4-10 x 1 1/4 x 47/64 | Hex Nut | Use with 565-337 Stud |
| 565-497 | 7/16 Dowell Washer | (Sleeve) .740 O.D. | No. BB-1142B, use with both 565-190 & 565-191 Studs |

WHEEL BOLTS AND NUTS BOULOUS ET GOUJONS DE ROUE

565
Series

HEAVY TRUCK

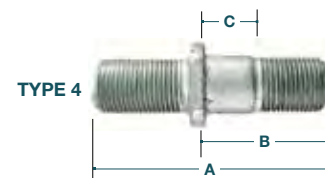

TYPE 4

Standard Package 10 Pcs.

| Stock No. | Type | Thread Diameter | DIMENSIONS | | | CROSS REFERENCE | | |
|-----------|------|-----------------|------------|---------|---------|-----------------|-------------|----------|
| | | | A | B | C | BUDD | FORD | G.M. |
| 565-044 | 4 | 3/4-16 | 3-27/32 | 2-5/16 | 1-5/32 | 13990 | TUAA-1118 | 244626 |
| 565-045 | | | | | | 1399-L | TUAA-1119-L | 244627-L |
| 565-046 | 4 | 3/4-16 | 4-7/32 | 2-11/16 | 1-7/16 | 17123 | | 2022806 |
| 565-047 | | | | | | 17124-L | | 2022807 |
| 565-066 | 4 | 3/4-16 | 4-17/32 | 3" | 1-15/16 | 16271 | | |
| 565-068 | 4 | 3/4-16 | 4-1/32 | 2-1/2 | 1-9/32 | 19004 | | |
| 565-069 | | | | | | 19005-L | | |

**WHEEL BOLT AND NUT ASSORTMENTS
ASSORTIMENTS DE BOULONS ET
ÉCROUS DE ROUE**

MERCHANDISER

No. 022-055

Papco[®] Mega-Paks' are uniformly priced packages of the most popular inch & metric Wheel Bolts and Nuts. Each 'Mega-Pak' features an illustrated, colour coded label, suggested selling price and a double strength drawer box. 'Papco' 'Mega-Paks' are available individually or in a factory prepared Merchandiser No. 022-055 containing 35 sizes of the fastest selling sizes of GM, Ford, Chrysler and Import Wheel Parts.

- Sturdy, Heavy Gauge, Reinforced Steel Cabinet
- Use on Works Bench or Hang on Wall
- Colourful-Durable-Efficient
- Includes handy Bolt measuring Gauge



022-055

18-1/2" wide
14-3/4" high

| Part No | Cat. No. | Pcs. | Part No | Cat. No. | Pcs. | Part No. | Cat. No. | Pcs. | Part No. | Cat. No. | Pcs. |
|---------|-----------|------|---------|-----------|------|----------|-----------|------|----------|-----------|------|
| 025-712 | (560-172) | 2 | 025-874 | (559-074) | 1 | 025-915 | (561-115) | 2 | 025-963 | (559-163) | 3 |
| 025-715 | (559-150) | 4 | 025-875 | (559-075) | 4 | 025-916 | (561-168) | 2 | 025-964 | (559-064) | 3 |
| 025-738 | (560-138) | 3 | 025-891 | (559-191) | 2 | 025-925 | (559-125) | 4 | 025-967 | (560-367) | 2 |
| 025-748 | (558-148) | 3 | 025-892 | (559-192) | 2 | 025-926 | (561-126) | 2 | 025-968 | (560-368) | 2 |
| 025-750 | (561-250) | 2 | 025-900 | (558-100) | 3 | 025-935 | (560-355) | 2 | 025-969 | (561-169) | 2 |
| 025-755 | (560-155) | 4 | 025-903 | (560-103) | 3 | 025-938 | (559-138) | 1 | 025-976 | (561-376) | 2 |
| 025-772 | (559-172) | 3 | 025-908 | (561-108) | 3 | 025-946 | (561-416) | 1 | 025-978 | (561-378) | 2 |
| 025-773 | (560-173) | 2 | 025-909 | (561-109) | 3 | 025-954 | (561-154) | 3 | 025-996 | (561-369) | 2 |
| 025-816 | (558-016) | 5 | 025-910 | (561-110) | 3 | 025-962 | (561-126) | 2 | | | |

UTILITY ASSORTMENT

No. 020-311

This Utility Assortment contains 8 sizes of the fastest moving Papco[®] Wheel Nuts.

CONTENTS OF ASSORTMENT No. 020-311

| Part No. | Pcs. | Part No. | Pcs. | Part No. | Pcs. |
|----------|------|----------|------|----------|------|
| 558-014 | 5 | 558-044 | 5 | 559-125 | 5 |
| 558-016 | 5 | 558-047 | 5 | 559-150 | 5 |
| 558-027 | 5 | 558-100 | 5 | | |

MASTER ASSORTMENT

No. 020-658

A Master Assortment containing 20 sizes of the most popular Wheel Bolts and Nuts for GM, Ford, Chrysler, AMC and Imports.

CONTENTS OF ASSORTMENT No. 020-658

| Part No. | Pcs. | Part No. | Pcs. | Part No. | Pcs. |
|----------|------|----------|------|----------|------|
| 560-103 | 5 | 560-173 | 5 | 561-248 | 5 |
| 560-114 | 5 | 560-386 | 5 | 561-251 | 5 |
| 560-138 | 5 | 561-108 | 5 | 558-014 | 10 |
| 560-148 | 5 | 561-109 | 5 | 558-016 | 10 |
| 560-155 | 5 | 561-110 | 10 | 558-027 | 10 |
| 560-167 | 5 | 561-122 | 5 | 559-150 | 10 |
| 560-172 | 5 | 561-154 | 5 | | |

SUPER-SERVICE ASSORTMENT

No. 020-802

A 'Super-Service' Assortment containing 32 of the most popular Wheel Bolts and Nuts for GM, Ford, Chrysler, AMC and Imports.

CONTENTS OF ASSORTMENT No. 020-802

| Part No. | Pcs. | Part No. | Pcs. | Part No. | Pcs. |
|----------|------|----------|------|----------|------|
| 560-102 | 5 | 560-186 | 5 | 561-167 | 5 |
| 560-103 | 5 | 560-386 | 5 | 561-248 | 5 |
| 560-105 | 5 | 561-100 | 5 | 561-251 | 5 |
| 560-110 | 5 | 561-102 | 5 | 561-380 | 5 |
| 560-114 | 5 | 561-106 | 5 | 558-014 | 10 |
| 560-138 | 5 | 561-108 | 5 | 558-016 | 10 |
| 560-148 | 5 | 561-109 | 5 | 558-027 | 10 |
| 560-155 | 5 | 561-110 | 5 | 559-125 | 10 |
| 560-167 | 5 | 561-122 | 5 | 559-150 | 10 |
| 560-172 | 5 | 561-154 | 5 | | |
| 560-173 | 5 | 561-166 | 5 | | |



020-311



020-658



020-802

ELECTRICAL

ÉLECTRICITÉ



WIRING TERMINALS

INSULATING P.V.C. TAPE

CRIMPING TOOL

CABLE TIES

WIRE GROMMETS

FUSE ACCESSORIES

SHRINK TUBING

CIRCUIT TESTERS

TEST CLIPS

CHARGING CLIPS

TEST LEADS

BATTERY TERMINALS

BATTERY BOOSTER CLAMPS

**BATTERY BOOSTER AND
TERMINAL CLEANERS**

BATTERY HOLD DOWN BOLTS

**UNIVERSAL BATTERY
HOLD DOWNS**













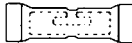

























**BATTERY TERMINAL
BOLTS AND NUTS**

**WIRING TERMINALS
COSSE SANS SOUDRE**

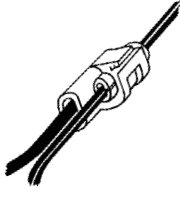
**569
Series**

INSULATED SOLDERLESS TYPE

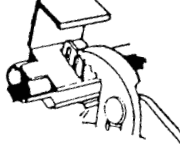
Papco® Wiring Terminals are constructed from pure electrolytic copper, annealed and electro-tin plated. The one-piece construction provides a terminal of maximum strength and electrical conductivity. The electro-tin plating affords maximum protection against corrosion. Funnel barrel entry assures easy wire insertion and a positive, solid crimp. Insulation is colour coded for the appropriate wire gauge: Red 22-18, Blue 18-14 and Yellow 12-10.

| Stock No. | Type | Stud Size | Pcs/Box | Stock No. | Type | Stud Size | Pcs/Box | Stock No. | Type | Stud Size | Pcs/Box |
|-------------------------|--|-----------------|---------|-------------------------|--|------------------|---------|--|--|-----------------|---------|
| 22-18 WIRE GAUGE | | | | 18-14 WIRE GAUGE | | | | 18-14 WIRE GAUGE | | | |
| 569-415 |  Ring | No. 4 - No. 6 | 50 | 569-465 |  Hook | No. 8 - No. 10 | 50 | 569-525 |  8-478 Recep. | - | 25 |
| 569-420 |  Ring | No. 8 - No. 10 | 50 | 569-466 |  Spade | No. 4 - No. 6 | 50 | 12-10 WIRE GAUGE | | | |
| 569-421 |  Ring | No. 12 - No. 14 | 50 | 569-467 |  Spade | No. 8 - No. 10 | 50 | 569-511 |  Ring | No. 8 - No. 10 | 50 |
| 569-422 |  Multi Fit | No. 6 - No. 10 | 50 | 569-468 |  "Snap" Spade | No. 8 | 50 | 569-512 |  Ring | No. 12 - No. 14 | 50 |
| 569-424 |  Hook | No. 8 - No. 10 | 50 | 569-469 |  "Snap" Spade | No. 10 | 50 | 569-513 |  Ring | 5/16 - 3/8 | 50 |
| 569-425 |  Spade | No. 4 - No. 6 | 50 | 569-470 |  Three Way | - | 25 | 569-531 |  Multi Fit | No. 6 - No. 10 | 25 |
| 569-426 |  Spade | No. 8 - No. 10 | 50 | | | | | 569-516 |  Spade | No. 8 - No. 10 | 50 |
| 569-432 |  Butt | - | 50 | 569-473 |  Butt | - | 50 | 569-522 |  Butt | - | 50 |
| 569-435 |  Insul. Quick Disc. | 1/4 F | 25 | 569-474 |  Quick Disc. | 1/4 F | 50 | 569-523 |  Insul. Quick Disc. | 1/4 F | 25 |
| 569-436 |  Insul. Quick Disc. | 1/4 M | 25 | 569-475 |  Quick Disc. | 1/4 M | 50 | 569-524 |  Insul. Quick Disc. | 1/4 M | 25 |
| 18-14 WIRE GAUGE | | | | 569-476 |  Insul. Quick Disc. | 1/4 F | 25 | 569-529 |  Closed end | - | 50 |
| 569-460 |  Ring | No. 4 - No. 6 | 50 | 569-477 |  Insul. Quick Disc. | 1/4 M | 25 |  <p>T-Tap Connectors Use in trunk to trailer hook-ups. T-splice stop lights and turn signals without stripping wires. Snap plug allows easy disconnect.</p>  | | | |
| 569-461 |  Ring | No. 8 - No. 10 | 50 | 569-478 |  Bullet | - | 50 | | | | |
| 569-462 |  Ring | No. 12 - 1/4 | 50 | 569-500 |  SPEE-DEE Connectors Make safe, fast, dependable connections. No wire stripping - no cutting - works on 14-18 wire gauge. Use standard pliers. The snap cover gives a completely insulated connection. Polypropylene case maintains live action. | 25 Pieces | | | | | |
| 569-464 |  Multi Fit | No. 6 - No. 10 | 50 | | | | | | | | |
| | | | | | | | | 569-530 | 25 Pieces | | |
| | | | | | | | | For other assortments of Papco® Wiring Terminals and Crimping Tools see next page. | | | |

INSULATING PVC COLD WEATHER TAPE RUBAN BASSE TEMPÉRATURE-FROIDE

Temperature rating: -18°C to 90°C

ORDER BY STOCK NUMBER Standard Package: 10 Rolls

| Stock No. | Size | Length per Roll | Colour |
|-----------|------------|-----------------|--------|
| 121-125 | 8mil x 3/4 | 66 feet | Black |



Used for protecting electrical parts and wires. These tapes provide required insulation capacity, high voltage and many more.

- CSA approved
- High Quality
- Colour: Black
- Flame retardant

INSULATING P.V.C. TAPE RUBAN ISOLANTE EN P.V.C.

Temperature rating: -7°C to 80°C

ORDER BY STOCK NUMBER Standard Package: 10 Rolls

| Stock No. | Size | Length per Roll | Colour |
|-----------|------------|-----------------|--------|
| 121-126 | 7mil x 3/4 | 66 feet | Black |
| 121-127 | 7mil x 3/4 | 66 feet | Blue |
| 121-128 | 7mil x 3/4 | 66 feet | Red |
| 121-129 | 7mil x 3/4 | 66 feet | Yellow |
| 121-130 | 7mil x 3/4 | 66 feet | Green |
| 121-131 | 7mil x 3/4 | 66 feet | White |



WIRING TERMINAL ASSORTMENTS ASSORTIMENTS DE BORNES ÉLECTRIQUES

GARAGE ASSORTMENT

No. 020-067

Contains 45 Ring, Spade, Multi-Fit and Butt Terminals. 15 sizes packed in a rigid, transparent plastic box.

020-067



020-650

MASTER ASSORTMENT

No. 020-650

This assortment contains 32 items for a total of 325 pieces of the most popular Ring, Spade, Hook, Butt and Quick Disconnect Terminals. Metal box with moulded plastic compartments features grease resistant lid label with actual size illustrations a handy wire size and stud size chart.

Size: 9-3/4" W x 13-3/4" L x 2" D.

SUPER SERVICE ASSORTMENT

No. 020-812

Contains 500 Wiring Terminals - complete coverage of all sizes listed. Large size, rigid metal box with high-strength plastic compartments.

Size: 12" W x 18" L x 3" D.

For more details see page 10.

020-812



**CRIMPING TOOL
OUTIL COSSE**

**569
Series**

No. 569-300

Five in one Papco[®] Crimping Tool is capable of performing five operations: Crimper (both insulated and non-insulated), Wire Cutter, Wire Stripper and Bolt Cutter. Individually carded.

Order by card number.



**CABLE TIES
SANGLES POUR CABLE**



Self-locking nylon ties for quick, simple bundling and mounting. Material is High-Strength Black Nylon 6/6 for increased resistance to outdoor exposure and ultra-violet light. Use to secure wiring harness, cables, hose, wires and pipes, and to prevent damage from moving parts or hot engine components. Packed in handy, sealed poly-bags in quantities shown.

ORDER BY STOCK NUMBER

| Stock No. | Bundle Dia. | Length | Tensile Strength | Std. Pkg. |
|---------------|-------------|---------|------------------|-----------|
| Standard Ties | | | | |
| 569-701 | 3/4" | 4" | 18 lbs. | 100 |
| 569-704 | 1-1/4" | 5-1/2" | 40 lbs. | 100 |
| 569-706 | 2" | 8" | 50 lbs. | 100 |
| 569-708 | 4" | 14-1/2" | 50 lbs. | 10 |
| 569-710 | 4" | 14-1/2" | 120 lbs. | 10 |
| Mounting Ties | | | | |
| 569-714 | 2" | 8" | 50 lbs. | 25 |



569-701

**WIRE GROMMETS
BAGUES POUR FIL**

OIL RESISTANT BLACK VINYL

Prevents insulation damage, shorts and leaks.

ORDER BY STOCK NUMBER

Standard Package: 10 Pieces

| Stock No. | Size | Stock No. | Size |
|-----------|-----------------------|-----------|----------------------|
| 569-230 | 3/8 O.D. x 1/4 I.D. | 569-236 | 1/2 O.D. x 3/8 I.D. |
| 569-231 | 7/16 O.D. x 5/16 I.D. | 569-237 | 5/8 O.D. x 3/8 I.D. |
| 569-232 | 1/4 O.D. x 1/8 I.D. | 569-238 | 5/8 O.D. x 1/2 I.D. |
| 569-233 | 5/16 O.D. x 3/16 I.D. | 569-240 | 7/8 O.D. x 5/8 I.D. |
| 569-234 | 3/8 O.D. x 1/4 I.D. | 569-241 | 1" O.D. x 11/16 I.D. |



**FUSE ACCESSORIES
ACCESORIES POUR FUSIBLE**

ORDER BY STOCK NUMBER

Standard Package: 5 Pieces

| Stock No. | Description |
|-----------|---|
| 569-029 | In-line Fuse Holder with 10 AMP Fuse, 12 Ga. wire. |
| 569-030 | Blade (ATO) Type Fuse Holder for 3 to 20 AMP Fuses. |



569-029



569-030

SHRINK TUBING TUBE RETRAIT

Insulates, groups and weather proofs wiring connections.
Charcoal grey tubing can be cut easily to suit length required.
Shrink with warm air blower.

ORDER BY STOCK NUMBER

| Stock No. | Size | Standard Package |
|---------------|----------------|------------------|
| Standard Ties | | |
| 569-200 | 3/16 I.D. x 3" | 25 |
| 569-201 | 1/4 I.D. x 3" | 25 |
| 569-203 | 3/8 I.D. x 3" | 25 |



CIRCUIT TESTERS VÉRIFICATEUR DE CIRCUIT

Tests for voltage presence in circuits. Locates improper connections, shorts and broken wires.

6-12 VOLTS CIRCUIT TESTER

No. 570-100

The most popular and largest selling tester.
Quickly and accurately tests all 6 to 12V systems.
Includes a spare bulb and extra long 48" lead.
Individually carded.



570-100

HI-LO VOLTAGE CIRCUIT TESTER

No. 570-101

All the proven features of the popular Part No. 570-100 Circuit Tester - plus the ability to test Hi-Voltage circuits such as Spark Plugs.
Checks for broken insulators, excessive gap, poor wire, fouled or worn spark plugs.



570-101

LED DISPLAY AUTO CIRCUIT TEST

No. 570-103

Professional quality Hi-Lo Voltage Circuit Tester accurately and quickly tests live wires, batteries and ignition systems including Spark Plugs. LED Display on side of tester indicates degree of battery charge.
Individually carded.



570-103

6, 12, 24 VOLTS CIRCUIT TESTER

No. 570-105

Professional quality tester features unbreakable plastic handle, heavy duty ground clip, 60" long rubber coated, heavy duty lead wire. Tests all 6, 12 and 24 Volts systems with power on. Individually carded.



570-105

**TEST CLIPS
PINCES DE VÉRIFIER**

**570
Series**

ALLIGATOR TYPE

A handy clip used in test work on ignition, radio and electrical applications. Strong, slim jaws with nesting teeth for good contact. Bright plated steel - 2" long - 3/8" jaw spread. Order by stock number 570-129. Standard package 10 clips.

570-129



CARD

No. 570-139

Convenient skin-packed card contains four Alligator Type Test Clips. Order by card number.



570-139

ASSORTMENT DISPLAY

No. 020-879

Contains 36 Alligator Type Test Clips No. 570-129. Attractive three colour point of purchase display card. See page 11.

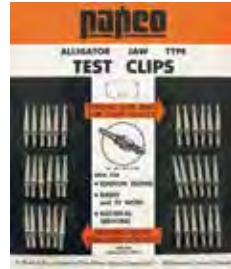

570-139

**CHARGING CLIPS
PINCES DE CHARGE**

ORDER BY STOCK NUMBER

Standard Package: 10 Clips

| Stock No. | Size | Capacity | Jaw Spread | Length |
|-----------|--------|----------|------------|--------|
| 570-130 | Small | 10 AMP | 1/2" | 2" |
| 570-131 | Medium | 20 AMP | 1" | 2-7/8" |
| 570-134 | Large | 50 AMP | 1-1/4" | 4" |

- 'Bull-dog' teeth for positive contact.
- Heavily plated to resist corrosion.
- Feed-thru neck prevents twisting.
- Oversize screw head for easier wiring.



570-131

Convenient skin-packed card contains four Charging Clips. Three sizes available. Order by card number.

ORDER BY STOCK NUMBER

| Card No. | Capacity |
|----------|----------|
| 570-140 | 10 AMP |
| 570-141 | 30 AMP |
| 570-144 | 50 AMP |

570-140



**TEST LEADS
FILS DE VÉRIFIER**

CARD

No. 570-110

Electrical test leads for auto, marine, hobby, shop, household and many other applications. Quickly shows hidden trouble in electrical systems. Consists of one black and one red extra long 48" leads complete with insulated, plated steel alligator clips fitted to both ends. Individually packaged.

570-110



**BATTERY TERMINAL AND GEAR PULLER
ARRACHE-COSSES/PIGNON**

CARD

No. 570-260

Use this popular tool to raise the Terminal off the post. A few turns applies even pressure without risk of damage. Individually carded.



570-260

BATTERY TERMINALS COSSES DE BATTERIE

570
Series

All Papco[®] Battery Terminals are made of Lead Alloy or Brass.

ORDER BY STOCK NUMBER

Standard Package: 25 Terminals

| Stock No. 570-346 | Stock No. 570-366 | Stock No. 570-376 | Stock No. 570-395 |
|---|---|---|--|
| UNIVERSAL SIDE MOUNT TERMINAL  No. 00 down to No. 6 gauge | BRASS MARINE TERMINALS <ul style="list-style-type: none"> • Polarity specific - meets U.S. Coast Guard regulations • Brass construction, fasteners included  Standard Package: 10 positive; 10 negative No. 00 down to No. 6 gauge | UNIVERSAL STRAIGHT TYPE TERMINAL  No. 0 and 1 | UNIVERSAL TERMINAL  No. 00 down to No. 6 gauge |

UNIVERSAL BATTERY TERMINAL COSSE DE BATTERIE UNIVERSEL

SOLDERLESS TYPE



020-870

ASSORTMENT DISPLAY

No. 020-870

Contains 10 Universal Solderless Battery Terminals No. 570-395 (see above). Attractive three colour display card.

CARD

No. 570-396

Universal Solderless Battery Terminal holds No. 00 down to No. 6 gauge. Top plate reverses - holds flat strap or smaller wire. Fits positive or negative posts.



570-396

UNIVERSAL MARINE BATTERY TERMINAL COSSE DE BATTERIE TYPE MARIN UNIVERSEL

SOLDERLESS TYPE



020-868

ASSORTMENT DISPLAY

No. 020-868

Contains 10 Universal Marine Type Battery Terminals No. 570-366 (see above). Attractive three colour display card.

5 positive posts
5 negative posts

CARD

No. 570-397

Universal Marine Type Battery Terminal holds No. 00 down to No. 6 gauge. Forged Brass for high conductivity. Heavily plated. Fits positive or negative posts.



570-397

UNIVERSAL SIDE TERMINAL COSSE DE BATTERIE LATERAL UNIVERSEL

SOLDERLESS TYPE



020-869

ASSORTMENT DISPLAY

No. 020-869

Contains 8 Universal Side Terminals No. 570-346 (see above). Attractive three colour point of purchase display card.

CARD

No. 570-398

Universal Side Terminals fits both positive and negative posts. Convenient skin-packed card contains two terminals. Order by card number.



570-398

**BATTERY TERMINAL PROTECTORS
PROTECTEURS DE COSSE DE BATTERIE**

**570
Series**

Special polyester pad impregnated with a chemical corrosion inhibitor that prevents power robbing corrosion build-up. Extends life of terminals and hold downs. Easily installed.
25 Red and 25 Black per jar.

ORDER BY STOCK NUMBER

| Card No. | Application |
|----------|-----------------------------|
| 570-427 | Post and side mount in one. |

Side Terminal

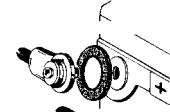

Post Terminal

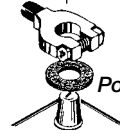

570-427

**BATTERY BOOSTER CLAMPS
COLLIERS DE CHARGE-BATTERIE**



020-889

500 AMP

ASSORTMENT DISPLAY

No. 020-889

Five pair 500 AMP Professional Duty clamps with vinyl insulated, non-slip handles on attractive three colour point of purchase display card.

CARD

No. 570-245

500 AMP Professional Duty clamp made of heavy gauge steel, bright nickel plated complete with cable lug. Colour coded vinyl, non-slip insulated handles. Convenient skin-packed card contains two clamps - one red, one black. Order by card number.



570-245

**BATTERY TESTER AND BOOSTER ADAPTORS
VÉRIFICATEUR ET COLLIERS DE CHARGE-BATTERIE**



570-250

BATTERY TESTER

No. 570-250

Tests all 6,12 and 24 Volt Batteries. Accurately and quickly indicates the degree of charge in each cell. Individually blister-packed. Order by part number 570-250.

BATTERY BOOSTER ADAPTORS

No. 570-200

Made of copper plated heavy duty steel for maximum conductivity. For use on all side terminal batteries. Installs between the terminal and the battery. Makes an ideal charging connection for hard-to-reach and hard-to-grip side mount terminals.

For Side Terminals



570-200

**UNIVERSAL BATTERY AND CHARGING POST
PILE UNIVERSELLE POSTE DE CHARGEMENT**

No. 570-344

Use two ways:

- (1) As Charging Post - just screw into side mount battery and attach booster clamps.
- (2) As Battery Post - screw into side mount battery and it becomes a post - attach conventional terminals.

Convenient skin-packed card contains 2 complete charging post.

For Side Mount Batteries



570-344

500 AMP

BATTERY POST AND TERMINAL CLEANERS NETTOIE-BORNES / COSSES

**570
Series**

No. 570-270

This tool quickly removes corrosion and scale from the terminal. Wire brush in base cleans the battery post. Helps maintain metal-to-metal contact. Individually Carded.

Order by card number.



570-270

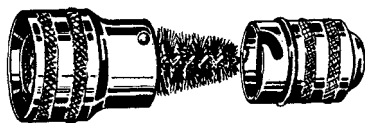

No. 570-275

Professional type, heavy duty one piece tool. Quickly and easily removes corrosion and dirt build-up that causes grounding on battery posts and terminals. Specially designed and clearly marked for cleaning either positive or negative posts. Tapered reamer for cleaning all post type battery terminals.



570-275

BATTERY HOLD DOWN BOLTS BOULONS DE FIXE-BATTERIE

All Bolts are plated and include Wing Nut and Washer. Convenient skin-packed cards contain two complete Bolts.



Type 1

Type 2

Type 3

Type 4

| Card No. | Type | Size | Description | Thread | Application | Factory No. |
|----------|------|-----------------|------------------------------|--------|--------------------------------|-------------|
| 570-610 | 2 | 1/4-20 x 10-1/2 | Round Hook | 4" | Universal | 3688699 |
| 570-611 | 2 | 1/4-20 x 10 | Round Hook | 4" | Universal | |
| 570-612 | 1 | 5/16-18 x 12 | Carriage Head | 5-1/2" | Universal | |
| 570-613 | 2 | 5/16-18 x 12 | Round Hook | 5" | Universal | |
| 570-614 | 3 | 1/4-20 x 10-1/4 | Right Angle | 4" | Universal | |
| 570-615 | 2 | 5/16-18 x 7-1/2 | Round Hook | 4" | G.M. Products | |
| 570-616 | 4 | 3/8-16 x 6 | Flat End with 2 mount screws | 2-1/4" | Chrysler Products (Outer bolt) | |

MASTER ASSORTMENT

No. 020-628

Garages - Service Stations - can replace any Battery Hold Down Bolt with the complete coverage of this assortment.

- Contains 34 Bolts, 130 pieces. 7 sizes complete with nuts and washers.
- All metal box - hinged lid.
- Handy carrying handle with safety snap lock.
- Illustrated label shows every part.



020-628

**UNIVERSAL BATTERY HOLD DOWNS
FIXE - BATTERIE UNIVERSEL**

570 Series

These four styles fit most popular batteries. Made of vinyl coated steel or nylon, highly resistant to rust and corrosion. Individually skin-packed* on an attractive three colour display card. Contains all necessary hardware.

ORDER BY STOCK NUMBER

UNIVERSAL CROSS BAR TYPE

No. 570-508

Universal cross bar type fits battery groups 22F, 24, 27, 60.

UNIVERSAL END TYPE

No. 570-509

Universal end type for base mount battery groups 22NF, 27F and 29NF.

UNIVERSAL SIDE TYPE

No. 570-510

Universal side type for side mount battery groups 22F and 24C also end mount group 22F.

UNIVERSAL BATTERY HOLD DOWN CLAMPS

No. 570-512*

Contains two Universal Battery Hold Down clamps. Holds all types of batteries securely. Strong, flexible nylon will not break or corrode.

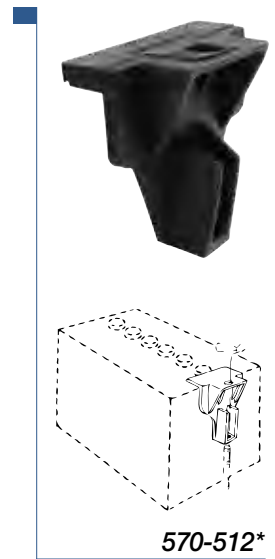
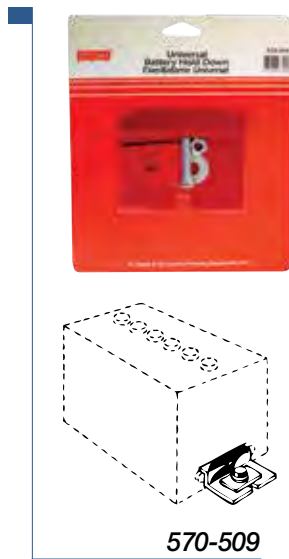
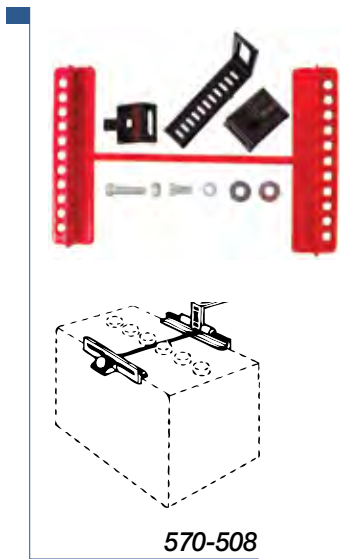

*2 per card.

**BATTERY TERMINAL BOLTS AND NUTS
BOULONS ET ÉCROUS POUR COSSE DE BATTERIE**

ORDER BY STOCK NUMBER Standard Package: 100 Pieces

SHOULDER BOLT and HEX NUT

No. 570-410
5/16 x 1-1/4

NUT

No. 570-411
5/16-18

SHOULDER BOLT and NUT

No. 570-412
5/16 x 1-1/4

SHOULDER NUT

No. 570-413
5/16-18

SIDE TERMINAL BOLT

No. 570-415
3/8 x 7/16

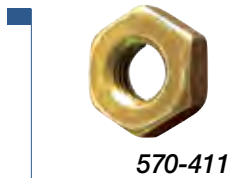

MISCELLANEOUS AUTO

PIÈCES AUTOMOBILES VARIÉES

STABILIZERS

**ADJUSTABLE COIL SPRING
EXPANDER**

SPRING CENTRE BOLTS & NUTS

UNIVERSAL TAILPIPE BRACKETS

CYLINDER HEAD BOLT KITS

PIPE PLUGS

WING NUT & HOOD PROP CLIP

THROTTLE ROD CLIPS & RETAINERS

THROTTLE BALL JOINTS

DRAIN COCKS

DRUM FAUCET

STUDS & NUTS

THICKNESS GAUGES

CALIPER

ANTI-FREEZE TESTER

CLAMPS

PUSH-PULL CONTROLS

UTILITY SPRINGS

VERNIER CONTROL, HEAVY DUTY

CHOKE CONVERSION KITS

**UNIVERSAL SPEEDOMETER
CABLE KIT**

CONTROL WIRE STOPS

CARBURETOR & THROTTLE RETURN SPRINGS

SHIM STOCKS

SNAP FASTENERS

'LIFT-THE-DOT' FASTENERS

TURN FASTENERS

GROMMETS

MAGNETS

VACUUM CONNECTORS

TAPS & DIES

THREAD CUTTING TOOLS

DRILL SETS

SOLID RUBBER, BLOCK TYPE STABILIZERS
STABILISATEURS EN CAOUTCHOUC SOLIDE

251
Series

- Corrects sagging of coil springs, bottoming and side sway.
- Convenient skin-packed card contains four stabilizers.

No. 251-031

For front coils only



251-031

Order by Card Number

No. 251-057

For rear coils only



251-057

Order by Card Number

Complete installation instructions on back of each card.

HEAVY DUTY RUBBER STABILIZERS
STABILISATEURS EN CAOUTCHOUC CHARGES ROBUSTES

- Recommended for rough road conditions and heavy duty applications such as taxis and police cars, etc.



251-059

Order by Card Number

ADJUSTABLE COIL SPRING EXPANDER
RELEVEURS DE RESSORT RÈGLABLE

251
Series

- Expands sagging coil springs for improved riding and steering qualities.
- Convenient skin-packed card contains two expanders and complete installation instructions.



Order by
Card Number

Coil Spring Expander

No. 020-882

Contains 12 Spring Expanders.

Mounted on an attractive three colour point of purchase display card.

Can be hung or set on counter.

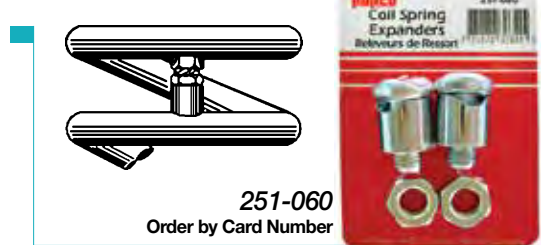

251-060

Order by Card Number

SPRING CENTRE BOLTS WITH NUTS BOULONS DE CENTRAGE DE RESSORT AVEC ÉCROUS

251 Series

Papco® Spring Centre Bolts are made of grade 2 steel, and are furnished with extra long threads in order to make them universal.

- Fillister head, Universal (long) Fine Threads with Hexagon Nut for all makes of Cars and Trucks (except Ford)



251-123

Black Finish

Order by Card Numbers

Standard Package 25 Bolts and Nuts

| Stock No. | Diameter x Length | Thread Lgth. | Bulk Qty. | Stock No. | Diameter x Length | Thread Lgth. | Bulk Qty. |
|-----------|-------------------|--------------|-----------|-----------|-------------------|--------------|-----------|
| 251-110 | 5/16 x 3-1/2 | 3 | 500 | 251-131 | 7/16 x 4-1/2 | 3 | 225 |
| 251-112 | 5/16 x 5 | 4 | 350 | 251-132 | 7/16 x 5 | 3 | 225 |
| 251-114 | 5/16 x 7 | 3 | 250 | 251-133 | 7/16 x 6 | 3 | 175 |
| 251-116 | 3/8 x 2 | 2 | 700 | 251-134 | 7/16 x 7 | 3 | 150 |
| 251-117 | 3/8 x 2-1/2 | 2 | 500 | 251-135 | 7/16 x 8 | 5 | 150 |
| 251-118 | 3/8 x 3 | 2-1/2 | 400 | 251-136 | 7/16 x 9 | 5 | 150 |
| 251-119 | 3/8 x 3-1/2 | 2-1/2 | 325 | 251-137 | 7/16 x 10 | 5 | 150 |
| 251-121 | 3/8 x 4 | 3 | 300 | 251-138 | 7/16 x 12 | 5 | 125 |
| 251-122 | 3/8 x 5 | 3 | 250 | 251-140 | 1/2 x 4 | 3 | 175 |
| 251-123 | 3/8 x 6 | 3 | 200 | 251-141 | 1/2 x 4-1/2 | 4 | 150 |
| 251-124 | 3/8 x 7 | 3 | 200 | 251-142 | 1/2 x 5 | 4 | 125 |
| 251-125 | 3/8 x 8 | 5 | 200 | 251-143 | 1/2 x 6 | 4 | 125 |
| 251-126 | 3/8 x 9 | 5 | 200 | 251-144 | 1/2 x 7 | 4 | 100 |
| 251-127 | 3/8 x 10 | 5 | 180 | 251-145 | 1/2 x 8 | 4 | 100 |
| 251-128 | 3/8 x 12 | 5 | 150 | 251-146 | 1/2 x 9 | 4 | 120 |
| 251-129 | 7/16 x 3 | 2 | 300 | 251-147 | 1/2 x 10 | 4 | 120 |
| 251-130 | 7/16 x 4 | 3 | 250 | 251-148 | 1/2 x 12 | 4 | 120 |

Note: Bulk is supplied without nuts.

DOUBLE THICKNESS NUTS ÉCROUS TRÈS HAUT

102 Series

Papco® Double Nuts are used on spring centre bolts, spring 'U' bolts, heavy duty truck wheels, tractor and implement bolts. All double thickness Nuts have UNF (S.A.E.) Fine Threads.

Light High Nuts



* 12 Pieces

Order by Card Number

Standard Package 24 pieces

| Stock No. | Size | Height | Width | Stock No. | Size | Height | Width |
|-----------|---------|-------------|-------------|-----------|----------|---------------|---------------|
| 102-018 | 3/8-24 | .491 - .509 | .551 - .562 | 102-027 | 3/4-16 | .985 - 1.015 | 1.088 - 1.125 |
| 102-020 | 7/16-20 | .599 - .619 | .675 - .688 | *102-028 | 7/8-14 | .1140 - 1.172 | 1.269 - 1.312 |
| 102-022 | 1/2-20 | .645 - .667 | .736 - .750 | *102-030 | 1-1/4 | 1.294 - .1330 | 1.450 - 1.500 |
| 102-023 | 9-16-18 | .754 - .778 | .861 - .875 | *102-034 | 1-1/4-12 | 1.666 - 1.710 | 1.812 - 1.875 |
| 102-024 | 5/8-18 | .831 - .857 | .922 - .938 | | | | |

POZI-LOK® DOUBLE NUTS ÉCROUS TRÈS HAUT POZI-LOK®

111 Series

These Nylon Insert, prevailing torque lock nuts offer excellent vibration resistance and assure positive locking under severe shock. Used for Spring Centre Bolts, Spring U-Bolts etc. UNF Fine Thread.

Order by Card Numbers

Standard Package 5 pieces

| Stock No. | Size | Dimensions | |
|-----------|---------|------------|---------------|
| | | Width 'A' | Thickness 'B' |
| 111-018 | 3/8-24 | 35/64 | 41/64 |
| 111-020 | 7/16-20 | 5/8 | 49/64 |
| 111-022 | 1/2-20 | 3/4 | 13/16 |
| 111-024 | 5/8-18 | 15/16 | 1" |

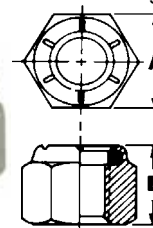

BRASS BRAKE BLOCK BOLTS BOULONS POUR SABOT DE FREIN

252 Series

Papco® Brass Brake Lining Fasteners, No. 252-221 and No. 252-354 are used to replace rivets on many truck and trailer applications. The 3/8" Dia. Brass Bolts are used on Brake Blocks. In each case the screw is Brass to avoid scoring and the hexagon nuts and lock washers are steel.

ORDER BY STOCK NUMBER

Standard Package: contains 100 Assemblies

| Stock No. | Size | Description | | | |
|-----------|----------------|---|--|--------------------|-------------------------------|
| 252-221 | 10-32 x 1 | Spec. Flat Brass Screw, Hex. Steel Nut, Lock Washer | | 252-221 252-354 | |
| 252-354 | 1/4-28 x 1 | Spec. Flat Brass Screw, Hex. Steel Nut, Lock Washer | | | |
| 252-489 | 3/8-16 x 1 | Flat Head Brass Screw, Hexagon Steel Nut | | | 252-489 252-491 252-493 |
| 252-491 | 3/8-16 x 1-1/4 | Flat Head Brass Screw, Hexagon Steel Nut | | | |
| 252-493 | 3/8-16 x 1-1/2 | Flat Head Brass Screw, Hexagon Steel Nut | | | |

UNIVERSAL TAILPIPE BRACKETS
SUPPORT UNIVERSEL DE TUYAU D'ÉCHAPPEMENT

256
Series

Used to suspend exhaust system components such as mufflers, catalytic converters and tailpipes. Brackets No. 256-002 and 256-003 are used with muffler clamps.

Order by Stock Number Individually Packaged

| Stock No. | Size & Description |
|-----------|--------------------------------------|
| 256-001 | 6" Steel Strap 1-1/2 - 2-1/2 OD Pipe |
| 256-002 | 4" Rubber Strap - 4 holes |
| 256-003 | 7" Steel Strap Swivel End |

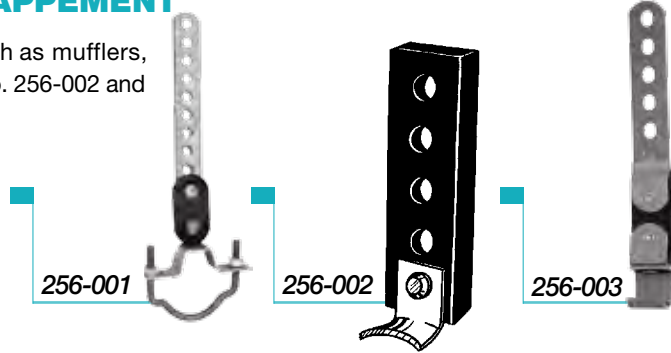

EXHAUST SYSTEM FASTENERS MASTER ASSORTMENT
ASSORTIMENT GÉNÉRAL DE FIXATIONS
POUR SYSTÈMES D'ÉCHAPPEMENT

No. 020-639

Contains Cap Screws, Carriage Bolts, Brass and Steel Engine Stud Nuts and Finished Hex Nuts. Gives complete coverage of the most common Exhaust System Fasteners. Sizes and quantities based on popularity.



MANIFOLD STUDS AND NUTS
MASTER ASSORTMENT
ASSORTIMENT GÉNÉRAL DE GOUJONS
ET ÉCROUS POUR RÉPARTITEUR

No. 020-632

Contains manifold studs and brass nuts. For complete listing, see next page.

STARTER BOLTS
BOULONS À DEMARREUR

257
Series

These hexagon washer head medium carbon steel plated bolts are replacements for damaged or missing starter mounting bolts.



Order by Card Numbers

Standard Package 5 pieces

| Stock No. | Size | Application | Stock No. | Size | Application |
|-----------|-----------------|------------------------|-----------|-----------------|---------------------------------------|
| 257-005 | 3/8-16 x 1-5/16 | GM 4.4, 5.0 & 5.7 lit. | 257-055 | M10 x 1.5 x 45 | GM 2.0, 2.5 & 3.4 lit. |
| 257-007 | 3/8-16 x 1-7/8 | GM 3.8 lit., 6 cyl. | 257-060 | M10 x 1.5 x 102 | GM 2.8 & 3.1 lit. |
| 257-012 | 3/8-16 x 3-5/8 | GM 6 & 8 cyl. | 257-065 | M10 x 1.5 x 113 | GM 2.0, 2.5 & 3.4 lit. |
| 257-015 | 3/8-16 x 4-5/16 | GM 4.4, 5.0 & 5.7 lit. | 257-070 | M10 x 1.5 x 118 | GM 2.0, 2.2, 2.5, 2.8, 3.1 & 3.4 lit. |
| 257-017 | 3/8-16 x 4-1/2 | GM 4.3 & 5.0 lit. | | | |
| 257-018 | 3/8-16 x 4-5/8 | GM 5.0 & 5.7 lit. | | | |

ALTERNATOR BOLTS
BOULONS À ALTERNATEUR

These high-strength, head treated plated bolts are used as alternator mounting bolts on domestic and imported vehicles.



Order by Card Numbers

Standard Package 5 pieces

| Stock No. | Size | Application | Stock No. | Size | Application |
|-----------|-----------------|-------------|-----------|-----------------|-------------|
| 257-105 | 5/16-18 x 1-1/4 | Universal | 257-120 | 3/8-16 x 6 | GM |
| 257-110 | 5/16-18 x 5 | GM | 257-125 | 7/16-14 x 5-1/2 | Ford |
| 257-115 | 3/8-16 x 3-1/8 | GM | 257-155 | M10 x 1.5 x 80 | GM |
| 257-118 | 3/8-16 x 4 | Chrysler | 257-160 | M10 x 1.5 x 105 | GM |

CYLINDER HEAD BOLT KITS TROUSSE POUR BOULONS DE CULASSE

**257
Series**

Papco® Cylinder Head Bolts are made of high-strength Grade 8 steel. Original bolts may be permanently stretched when torqued. Torque-to-yield bolts **MUST** be replaced to avoid premature head gasket failure.

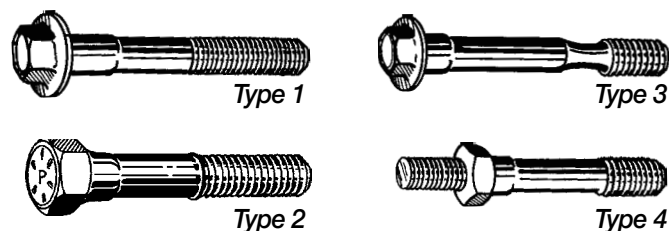

| Type | Year | Cyl. | Engine Size | Size | Kit No. | Trq. to Yield | Pcs. /Kit | Factory No. |
|-----------------|---------|------|------------------------|------------------|---------|---------------|-----------|-------------|
| CHRYSLER | | | | | | | | |
| 1 | 1981-up | (4) | 2.2L (135), 2.5L (153) | M11 x 1.5 x 120 | 257-301 | Yes | 10 | 6501433 |
| 1† | 1987-up | (6) | 3.0L (181) SOHC (Mits) | M12 x 1.25 x 102 | 257-303 | Yes | 16 | MD065959 |
| 1 | 1993-up | (6) | 3.5L | 1/2-13 x 1-7/8 | 257-304 | Yes | 16 | 6502665 |
| 1 | 1957-up | (8) | | (Short) | 257-305 | No | 10 | 6031045 |
| 1 | | | | (Medium) | | | | |
| 1 | | | | (Long) | | | | |
| | | | | M11 x 1.5 x 190 | | No | 2 | 2463260 |

| Type | Year | Cyl. | Engine Size | Size | Kit No. | Trq. to Yield | Pcs. /Kit | Factory No. |
|-------------|-----------|------|------------------------------|------------------|---------|---------------|-----------|-------------|
| FORD | | | | | | | | |
| 1 | 1981-1984 | (4) | 1.6L, 1.9L Escort | M10 x 1.5 x 130 | 257-310 | Yes | 10 | E4FZ-6065-A |
| 1 | 1974-95 | (4) | 2.3L (140) OHC | M12 x 1.75 x 100 | 257-311 | No | 10 | D4FZ-6065-A |
| 1 | 1986-up | (6) | 2.9L (177), 4.0L (244) Truck | M12 x 1.75 x 73 | 257-312 | Yes | 16 | E6TZ-6065-A |
| 1 | 1986-up | (6) | 3.0L (183) Exc: SHO | M11 x 1.5 x 102 | 257-313 | Yes | 16 | E8DZ-6065-A |
| 2 | 1982-up | (6) | 3.8L (232) | (Short) | 257-315 | Yes | 8 | F4SZ-6065-B |
| 2 | | | | (Long) | | | | |
| | | | | M11 x 1.5 x 100 | | Yes | 8 | F4SZ-6065-A |
| 1 | 1991-up | (8) | 4.6L (281) SOHC | M11 x 1.5 x 210 | 257316 | Yes | 20 | F5AZ-6065-A |
| 2 | 1980-up | (8) | 4.9L (300) | 7/16-14 x 4 | 257-317 | Yes | 14 | F3ZZ-6065-B |
| 2 | 1970-up | (8) | 5.0L (302) | (Long) | 257-318 | Yes | 10 | F3ZZ-6065-B |
| 2 | | | | (Short) | | | | |
| 4 | | | | (w/stud) | | | | |
| | | | | 7/16-14 x 3-7/8 | | Yes | 2 | F3ZZ-6065-D |
| 3 | 1970-up | (8) | 5.8L (351) Windsor | (Short) | 257-319 | No | 20 | C902-6065-A |
| 3 | | | | (Long) | | | | |
| | | | | 1/2-13 x 4 | | No | 20 | C902-6065B |

| Type | Year | Cyl. | Engine Size | Size | Kit No. | Trq. to Yield | Pcs. /Kit | Factory No. |
|-----------------------|---------|-------|------------------------------------|--------------------|---------|---------------|-----------|-------------------|
| GENERAL MOTORS | | | | | | | | |
| 1 | 1985-95 | (4) | 1.6L (98) 4, 5, 6 Geo | M10 x 1.5 x 94 | 257-331 | Yes | 10 | 96061591 |
| 3 | 1982-94 | (4) | 1.8L, 2.0L, OHC H, K, M | | 257-332 | Yes | 2 | 10031210 |
| 4 | | | | (w/stud) | | | | |
| 4 | | | | (w/stud) | | | | |
| | | | | M11 x 1.5 x 185 | | Yes | 4 | 10031213 |
| | | | | M11 x 1.5 x 165 | | Yes | 4 | 10031214 |
| 1 | 1987-93 | (4) | 2.3L (138) QUAD IV DOHC | | 257-334 | Yes | 2 | 22531281 |
| 1 | | | | (Long) | | | | |
| | | | | M12 x 1.75 x 98 | | Yes | 8 | 22531282 |
| 4 | 1980-up | (4) | 2.5L (151) A, E, 5, R, 2 | (w/stud) | 257-336 | Yes | 1 | 12338010 |
| 4 | | | | (w/stud) | | | | |
| 1 | | | | | | | | |
| | | | | M11 x 1.5 x 125 | | Yes | 1 | 12338012 |
| | | | | M11 x 1.5 x 99 | | Yes | 8 | 12338018 |
| 1 | 1987-96 | (6) | 2.8L (173) W, 3.1L (189) VIN T | | 257-338 | Yes | 8 | 10100033 |
| 1 | | | | | | | | |
| | | | | M11 x 1.5 x 108 | | Yes | 8 | 10227593 |
| 1 | 1982-95 | (6) | 2.8L (173), 3.1L (189) M, T, W | | 257-339 | No | 8 | 476572 |
| 1 | | | | | | | | |
| | | | | M11 x 1.5 x 93 | | No | 8 | 476543 |
| 3 | 1975-up | 6) | 3.8L (231) A, B, G | | 257-340 | No | 8 | 1243262 |
| 1 | | | | 2, 3, 7, 8, 9, C L | | | | |
| | | | | 7/16-14 x 2-11/16 | | No | 8 | 1253539 |
| 3 | 1955-up | (6-8) | 4.3L (262) Z, 305, 327 350, 400 | | 257-341 | No | 14 | 14082317 |
| 3 | | | | | | | | |
| 3 | | | | | | | | |
| | | | | 7/16-14 x 3-3/4* | | No | 16 | 14082316 |
| | | | | 7/16-14 x 1-3/4* | | No | 4 | 14082315 |
| | | | | 7/16-14 x 3* | | No | 4 | 14082315 |
| 1 | 1982-up | (8) | 6.2L (381), 6.5L (395) Diesel | 7/16-14 x 3 | 257-342 | No | 34 | 14077193 |
| 1 | 1971-up | (8) | 366, 427, 454 Truck | (Long) | 257-343 | No | 8 | 10141204, 3877668 |
| 1 | | | | (Short) | | | | |
| | | | | 7/16 x 2-1/16 | | No | 24 | 10141205, 3877669 |

† Round Head

* with GM 9985490 Thread Sealant

**with GM 6124M Thread Sealant

**SQUARE HEAD PIPE PLUGS
BOUCHONS DE TUYAU TÊTE CARRÉE**

**260
Series**

With **LOCTITE® Vibra-Seal®**

These forged steel pipe plugs are used as drain and filler plugs on all cars, trucks, tractors and stationary engines. Made with Dryseal American National Pipe Threads. For improved reliability Papco® Pipe Plugs feature LOCTITE® Vibra-Seal® pre-applied thread sealant.

ORDER BY STOCK NUMBER Standard Package: 12 Plugs

| Stock # | Iron Pipe Size Thread | Approximate Dia. Small End |
|---------|-----------------------|----------------------------|
| 260-901 | 1/8-27 | 3/8 |
| 260-902 | 1/4-18 | 1/2 |
| 260-903 | 3/8-18 | 5/8 |
| 260-904 | 1/2-14 | 7/8 |
| 260-906 | 3/4-14 | 1" |



GARAGE ASSORTMENT

No. 020-043

Contains 20 Square Head Pipe Plugs in 1/8", 1/4" and 3/8" iron pipe sizes. Packed in a clear, plastic box.

GARAGE ASSORTMENT

No. 020-087

Contains 20 Socket Pipe Plugs in 1/8, 1/4 and 3/8 iron pipe sizes. Packed in a sturdy, transparent, plastic box.

UTILITY ASSORTMENT

No. 020-332

Contains 42 Square Head Pipe Plugs in 1/8", 1/4", 3/8" and 1/2" pipe sizes. Packed in a sturdy fibreboard container with moulded compartments.



020-043



020-043

**SOCKET PIPE PLUGS
BOUCHONS DE TUYAU CREUX**

**260
Series**

ORDER BY STOCK NUMBER

| Stock # | Iron Pipe Size Thread |
|---------|-----------------------|
| 260-921 | 1/8-27 |
| 260-922 | 1/4-18 |
| 260-923 | 3/8-18 |
| 260-924 | 1/2-14 |



Standard Package: 12 Plugs

AIR CLEANER WING NUTS ÉCROUS À OREILLES POUR FILTRE À AIR

262
Series

Universal type replacements for lost or stripped Air Cleaner Wing Nuts. Self-threaded series nylon nuts cut their own thread and may be used on either inch or metric hold-down shafts.

ORDER BY STOCK NUMBER

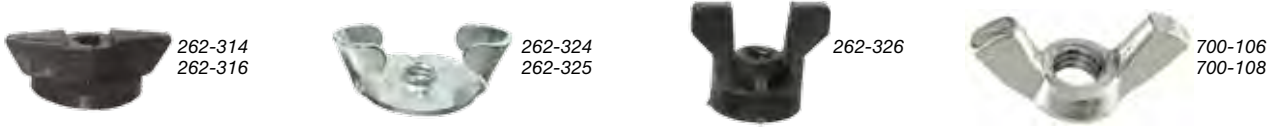
|  | | | | | | | |
|--|------------|----------------------|-----|-----------|-----------|-----------------|-----|
| Stock No. | Size | Description | Qty | Stock No. | Size | Description | Qty |
| 262-314 | 1/4 & 6 mm | Self Threading Nylon | 10 | 262-326 | 1/4-20 | Chrysler Nylon | 5 |
| 262-316 | 5/16 & 8mm | Self Threading Nylon | 10 | 700-106 | M6 x 1.0 | Metric Wing Nut | 25 |
| 262-324 | 1/4-20 | Universal Domestic | 10 | 700-108 | M8 x 1.25 | Metric Wing Nut | 25 |
| 262-325 | M6 x 1.0 | Universal Imports | 10 | | | | |

WING NUT AND HOOD PROP CLIP MASTER ASSORTMENT

No. 020-608

Contains 90 pieces - 16 sizes of all listed Air Cleaner Wing Nuts as above - plus 5 sizes of Hood Prop Clips (see page 7). Packed in a rigid, all metal lidded box.

020-608



**THROTTLE ROD CLIPS AND RETAINERS
ATTACHES DE TIGE À SOUPAPE**

**262
Series**

Papco[®] Throttle Rod Clips are made of hardened spring steel in right and left hand styles. The retainer springs, or hairpin cotters, are measured by the diameter of the centre eye.

ORDER BY STOCK NUMBER

|  | | | | | | | | | | | |
|--|--------|------|-----------|-----------|----------|------|-----------|-----------|------|------|-----------|
| Stock No. | Size | Type | Std. Pkg. | Stock No. | R. Dia. | Type | Std. Pkg. | Stock No. | Size | Type | Std. Pkg. |
| 262-008* | 5/32 R | 1 | 25 | 262-056* | 1/8 | 2 | 25 | 262-078* | 5/32 | 3 | 100 |
| 262-009* | 5/32 L | 1 | 25 | 262-060* | 1/4 | 2 | 25 | 262-080 | 7/32 | 3 | 100 |
| 262-010* | 3/16 R | 1 | 25 | 262-062* | 1/8 (GM) | 4 | 25 | 262-084 | 1/4 | 3 | 100 |
| 262-011* | 3/16 L | 1 | 25 | 262-064* | 1/4 (GM) | 4 | 25 | 262-086 | 5/16 | 3 | 100 |
| 262-014* | 1/4 R | 1 | 25 | 262-073* | 1/16 | 3 | 100 | 262-088 | 3/8 | 3 | 100 |
| 262-015* | 1/4 L | 1 | 25 | 262-075* | 5/64 | 3 | 100 | 268-516 | 5/16 | 5 | 18 |
| 262-054* | 3/32 | 2 | 25 | 262-076* | 1/8 | 3 | 100 | | | | |

*Retainers

CARBURETOR CLIP MASTER ASSORTMENT

No. 020-609

Contains 293 pieces, 18 sizes for complete coverage. Packed in an all metal, lidded box. See page 6 for contents listing.

THROTTLE ROD CLIP GARAGE ASSORTMENT

No. 020-022

Contains 104 pieces, *15 sizes as listed above, includes both clips and hairpin cotters. Packed in a transparent plastic box with individual sections. Useful for carburetor repair jobs.



020-022

**THROTTLE BALL JOINTS
JOINTS À ROTULE**

Used to adjust throttle linkages and control rods on automobiles, trucks, snowmobiles, marine and off the road equipment. Made of heat treated carbon steel and bright plated for corrosion resistance.

| | | |
|---------------------------|---|--|
| Type G (Solid) |  | High-strength design with good wear resistance for heavy duty service. Oil and gas resistant rubber shield protects against abrasive dirt. |
| Type A (Spring Loaded) |  | Conforms to S.A.E. Standards with case hardened seats and ball studs for extra wear resistance. Spring loaded for zero end-play. |
| Type P (Quick Disconnect) |  | Lightweight economical quick disconnect design. Ball studs can be removed from spring steel retaining clip for making length adjustments. |

Convenient skin-packed card contains one Ball Joint.

ORDER BY CARD NUMBER

Individually Carded

| Card No. | Type | Size | Card No. | Type | Size |
|----------|------|---------|----------|------|---------|
| 262-203 | G | 10-32 | 262-208 | G | 1/2-20 |
| 262-204 | G | 1/4-28 | 262-210 | A | 10-32 |
| 262-205 | G | 5/16-24 | 262-211* | A | 1/4-28 |
| 262-206* | G | 3/8-24 | 262-212* | A | 5/16-24 |
| 262-207 | G | 7/16-20 | 262-218 | P | 1/4-28 |

* Most Popular

DRAIN COCKS ROBINETS DE VIDANGE

263 Series

Papco[®] Plastic Drain cocks for low pressure applications. For water, air, gas, anti-freeze and other fluids. (Not intended for natural gas, LPG or lubricants.)



Order by Card Numbers

| Plastic Drain Cocks | | |
|---------------------|----------------|---|
| Stock No. | Pipe Size | Factory No. Appl. |
| 263-951 | 5/16 (7/16-20) | GM: 3042160 |
| 263-952 | 1/4 x 1-1/2 | GM: 305104 FORD: E1FZ-8115A |
| 263-953 | 1/4 x 1-7/8 | FORD: E57H-B115A |
| 263-957 | 10 mm x 1.25 | NISSAN: 21480-RD100 SUBARU: 7451-24010 |

Standard Package 5 pieces

| Brass Drain Cocks | | |
|-------------------|-----------|------------------|
| Stock No. | Pipe Size | Type |
| D40-A | 1/8 | Back Sealing |
| D40-B | 1/4 | Back Sealing |
| D40-C | 3/8 | Back Sealing |
| D43-A | 1/8 | Outlet Fitting |
| D44-A | 1/8 | Outlet Fitting |
| D39-B | 1/4 | External Sealing |

DRAIN COCKS MASTER ASSORTMENT ASSORTIMENT GÉNÉRAL DE ROBINETS DE VIDANGE

263 Series

No. 020-606

Contains 119 pieces of Plastic and Brass Drain Cocks - plus compression Sleeves, Nuts, Unions and four sizes of Hex Head Pipe Plugs.

- All metal box with hinged lid and handy carrying handle.
- Plastic, moulded compartmentalized tray.
- Illustrated lid label with retail price codes and refill stock numbers.

020-606



DRUM FAUCET

No. 913-026

For use with oils, kerosene, gasoline, naphtha, alcohol, lacquers, varnishes, thinners, solvents of all kinds, anti-freeze solutions and other liquids, hot or cold.

The Papco[®] Sette Faucet is simple in design and has an all nylon seat for extended life.

Extra thin liquids that are impossible to hold with ordinary faucets are held absolutely and permanently tight by Papco[®] Sette Faucets.

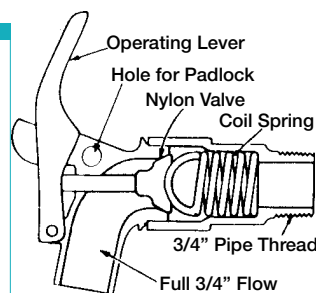

913-026

**ENGINE STUDS AND NUTS
GOUJONS ET ÉCROUS DE MOTEUR**

**264
Series**

Papco[®] Engine Studs will service all popular makes of cars. They have extra long threads and can be cut to size where a shorter stud is required.

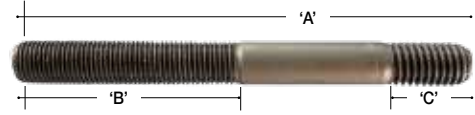

Order by Card Numbers

Standard Package 12 pieces

| Stock No. | Length Dia. x 'A' | Dimensions | | Stock No. | Length Dia. x 'A' | Dimensions | |
|-----------|-------------------|------------|---------|-----------|-------------------|------------|---------|
| | | 'B' | 'C' | | | 'B' | 'C' |
| 264-016 | 5/16 x 1-3/4 | 7/8 UNF | 5/8 UNC | 264-092 | 7/16 x 2-1/4 | 7/8 UNF | 7/8 UNC |
| 264-018 | 5/16 x 2 | 7/8 UNF | 3/4 UNC | 264-094 | 7/16 x 2-3/8 | 7/8 UNF | 5/8 UNC |
| 264-024 | 5/16 x 2-1/2 | 1-1/2 UNF | 1/2 UNC | 264-096 | 7/16 x 2-1/2 | 7/8 UNF | 3/4 UNC |
| 264-032 | 5/16 x 3 | 1-1/2 UNF | 5/8 UNC | 264-102 | 7/16 x 3-1/4 | 1-7/8 UNF | 5/8 UNC |
| 264-048 | 3/8 x 2 | 1 UNF | 3/4 UNC | 264-103 | 7/16 x 3-1/4 | 1 UNF | 3/4 UNC |
| 264-049 | 3/8 x 2 | 1 UNC | 5/8 UNC | 264-108 | 7/16 x 3-5/8 | 1-3/4 UNF | 5/8 UNC |
| 264-058 | 3/8 x 2-3/4 | 1 UNF | 3/4 UNC | 264-110 | 7/16 x 4 | 1-7/8 UNF | 5/8 UNC |
| 264-060 | 3/8 x 3 | 1-1/4 UNF | 3/4 UNC | 264-134 | 1/2 x 2-1/2 | 1 UNF | 3/4 UNC |
| 264-066 | 3/8 x 4 | 2 UNC | 3/4 UNC | 264-140 | 1/2 x 2-7/8 | 7/8 UNC | 3/4 UNC |
| 264-067 | 3/8 x 4 | 2 UNF | 3/4 UNC | 264-150 | 1/2 x 4 | 2 UNF | 3/4 UNC |
| 264-086 | 7/16 x 1-3/4 | 9/16 UNF | 1/2 UNC | | | | |
| 264-088 | 7/16 x 2 | 7/8 UNF | 3/4 UNC | | | | |

**MANIFOLD STUDS
GOUJONS POUR COLLECTEUR**

**264
Series**

Low Carbon Steel

Papco[®] Low - Carbon Manifold Studs are easily removed if rusted, broken or stripped. Simply drill out or burn out with a torch. Preferred by muffler shops everywhere. Coarse thread both ends.

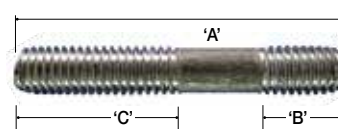

Order by Card Numbers

Standard Package 10 pieces

| Stock No. | Length Dia. x 'A' | Dimensions | | Stock No. | Length Dia. x 'A' | Dimensions | |
|-----------|-------------------|------------|----------|-----------|-------------------|------------|-------|
| | | 'B' | 'C' | | | 'B' | 'C' |
| 264-504 | 3/8-16 x 2 | 5/8 NC | 1-1/8 NC | 264-519 | 7/16 -14 x 3 | 5/8 NC | 2" NC |
| 264-507 | 3/8-16 x 2-1/2 | 5/8 NC | 1-1/4 NC | 264-523 | 7/16 -14 x 4 | 5/8 NC | 2" NC |
| 264-509 | 3/8-16 x 3 | 5/8 NC | 2" NC | 264-640 | M8 x 1.25 x 40 | 16 mm | 19 mm |
| 264-510 | 3/8-16 x 3-1/4 | 5/8 NC | 1-5/8 NC | 264-650 | M10 x 1.5 x 50 | 16 mm | 19 mm |
| 264-517 | 7/16-14 x 2-1/2 | 5/8 NC | 1-1/4 NC | | | | |

METRIC STUDS GOUJONS DE MOTEUR MÉTRIQUE

264
Series

Conform to I.S.O. Class 8.8 Specifications. For manifolds, rocker covers and general engine uses.

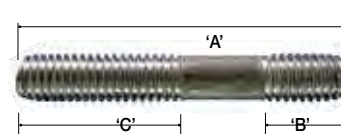

For Metric Steel Nuts see page 37.

Standard Package 10 Studs

| Stock No. | Dia. x Pitch x Length 'A' | 'B' mm | 'C' mm | Application | Stock No. | Dia. x Pitch x Length 'A' | 'B' mm | 'C' mm | Application |
|-----------|---------------------------|--------|--------|----------------------|-----------|--------------------------------|---------|----------|----------------|
| 264-230 | M6 x 1.00 x 30 mm | 14 | 12 | VW - 056 - 103 - 400 | 264-440 | M6 x 1.25 / M10 x 1.50 x 35 mm | 14 (M8) | 19 (M10) | Universal |
| 264-328 | M6 x 1.25 x 28 mm | 15 | 10 | VWN044 - 511 - 1 | 264-441 | M10 x 1.25 x 37 mm | 13 | 21 | Universal |
| 264-335 | M6 x 1.25 x 35 mm | 17 | 12 | VWN044 - 514 - 2 | 264-443 | M10 x 1.25 x 43 mm | 21 | 16 | DAT14064-N4200 |
| 264-338 | M6 x 1.25 x 38 mm | 20 | 10 | VWN14 - 443 - 8 | 264-450 | M10 x 1.25 x 50 mm | 25 | 15 | Universal |
| 264-346 | M6 x 1.25 x 46 mm | 23 | 16 | VWN044 - 410 - 2(-4) | 264-451 | M10 x 1.50 x 50 mm | 25 | 15 | Universal |
| 264-348 | M6 x 1.25 x 50 mm | 23 | 10 | Universal | 264-452 | M10 x 1.50 x 52 mm | 27 | 12 | Universal |
| 264-350 | M6 x 1.25 x 55 mm | 23 | 10 | Universal | 264-453 | M10 x 1.50 x 62 mm | 28 | 12 | Universal |
| 264-352 | M6 x 1.25 x 60 mm | 24 | 10 | Universal | 264-455 | M10 x 1.50 x 65 mm | 46.5 | 13.5 | Universal |
| 264-354 | M6 x 1.25 x 65 mm | 19 | 10 | Universal | 264-457 | M10 x 1.50 x 77 mm | 28 | 12 | Universal |
| 264-356 | M6 x 1.25 x 70 mm | 24 | 10 | Universal | | | | | |

ENGINE STUD NUTS GOUJONS DE MOTEUR

Standard Package 25 Nuts

| Hex Brass Nuts | | | |
|----------------|---------------|--------------------|-----------|
| Stock No. | Size & Thread | Width Across Flats | Thickness |
| 264-953 | 5/16 UNF | 1/2 | 17/64 |
| 264-954 | 5/16 UNC | 1/21 | 17/64 |
| 264-955 | 3/8 UNF | 9/16 | 21/64 |
| 264-956 | 3/8 UNC | 9/16 | 21/64 |
| 264-957 | 3/8 UNC | 9/16 | 5/8 |
| 264-958 | 7/16 UNF | 11/16 | 3/8 |
| 264-959 | 7/16 UNC | 5/8 | 3/8 |
| 264-960 | 1/2 UNF | 3/4 | 7/16 |
| 264-961 | 1/2 UNC | 3/4 | 7/16 |



Standard Package 25 Nuts

| High Strength Steel Nuts | | | |
|--------------------------|---------------|--------------------|-----------|
| Stock No. | Size & Thread | Width Across Flats | Thickness |
| 264-903 | 5/16 UNF | 1/2 | 17/64 |
| 264-905 | 3/8 UNF | 9/16 | 21/64 |
| 264-908 | 7/16 UNF | 11/16 | 3/8 |
| 264-909 | 7/16 UNC | 11/16 | 3/8 |
| 264-910 | 1/2 UNF | 3/4 | 7/16 |



For Papcolloy Hardened Steel Washers see page 63.

ENGINE STUDS AND NUTS MASTER ASSORTMENT ASSORTIMENT GÉNÉRAL DE GOUJONS ET ÉCROUS POUR MOTEUR

No. 020-632

Will service all exhaust manifold applications. Complete car coverage. All parts illustrated on hinged lid of sturdy metal merchandiser. Handy carrying handle with snap lock.

For **SUPER-SERVICE ASSORTMENT**
No. 020-818 of Engine Studs and Nuts
please refer to page 10.

020-632



**THICKNESS GAUGES
CALIBRES D'ÉPAISSEUR**

**267
Series**

Papco® Thickness Gauges are made from No. 1 Grade Swedish Steel, uniformly tempered and are of the highest accuracy obtainable. Each gauge is 12" long by 1/2" wide and has a hole punched in the end for hanging. The thickness in thousandths is permanently etched on the gauge.

Standard package contains six lengths of a size, and each gauge is individually cellophane wrapped.

ORDER BY STOCK NUMBER

Standard Package: 6 Lengths

| Stock No. | Thickness | Stock No. | Thickness | Stock No. | Thickness |
|-----------|-----------|-----------|-----------|-----------|-----------|
| 267-015 | .0015 | 267-110 | .010 | 267-120 | .020 |
| 267-020 | .002 | 267-111 | .011 | 267-122 | .022 |
| 267-025 | .0025 | 267-112 | .012 | 267-124 | .024 |
| 267-030 | .003 | 267-113 | .013 | 267-125 | .025 |
| 267-040 | .004 | 267-114 | .014 | 267-126 | .026 |
| 267-050 | .005 | 267-115 | .015 | 267-128 | .028 |
| 267-060 | .006 | 267-116 | .016 | 267-130 | .030 |
| 267-070 | .007 | 267-117 | .017 | 267-132 | .032 |
| 267-080 | .008 | 267-118 | .018 | 267-140 | .040 |
| 267-090 | .009 | 267-119 | .019 | | |

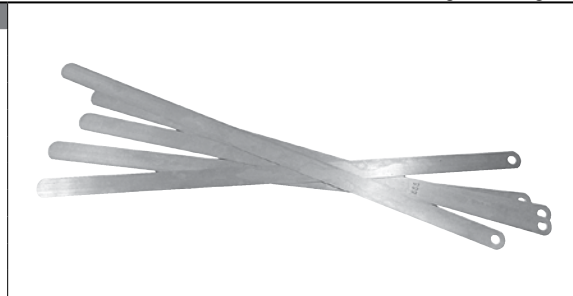

**PRECISION CALIPER
COMPAS PRÉCISION**

No. 022-031

Papco® Precision Caliper is made of high impact styrene. Useful for all types of measurements in both inch and metric. Measures inside diameter, outside diameter, length and depth. Scales in 1/16" or 1 mm increments. Individually skin-packed.



**BOLT AND NUT GAUGES
CALIBRES POUR BOULONS ET ÉCROUS**

No. 022-030

Bolt & Screw Gauge

Heavy duty, plastic gauge for measuring UNC, UNF and Metric bolts, nuts, screws and studs. Individually packaged.

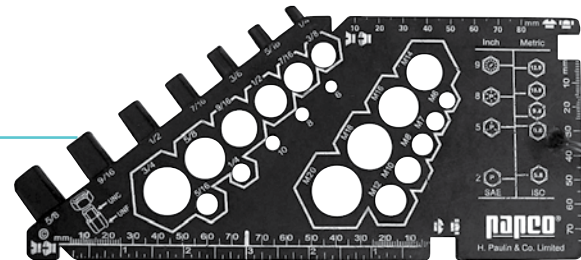

No. 022-034

Ultimate Bolt & Screw Gauge

Heavy duty steel construction. Measures bolts, nuts and screws by length, diameter and thread. Includes Imperial and Metric sizes (UNC & UNF) as per IFI Standard.



THREAD DETECTIVE® IMPERIAL/METRIC • IMPÉRIAL/MÉTRIQUE

No. 022-185

- This Thread Detective is an easy and precise thread identifier for both nuts and bolts, consisting of gliding gauges conveniently assembled onto a wire lanyard.
- It is well suited for distinguishing between similar inch and metric threads.
- Thread sizes are stamped onto each gauge and are coated with a PVC shrink tubing ensuring numbers will never rub off.
- Thread Detective® is equipped with a 3-3/8" (85mm) ruler for measuring stud lengths.
- It has a convenient extra long rope for those hard to reach places, as well as loops on each end for hanging.

Inch identifiers consist of nut and bolt sizes

6-32, 8-32, 10-24, 10-32, 1/4-20, 1/4-28, 5/16-18, 5/16-24, 3/8-16, 3/8-24, 7/16-14, 7/16-20, 1/2-13 and 1/2-20.

Metric identifiers consist of nut and bolt sizes

M4 x 0.7, M5 x 0.8, M6 x 1.0, M8 x 1.0, M8 x 1.25, M10 x 1.0, M10 x 1.25, M10 x 1.5, M12 x 1.25, M12 x 1.5 and M12 x 1.75.

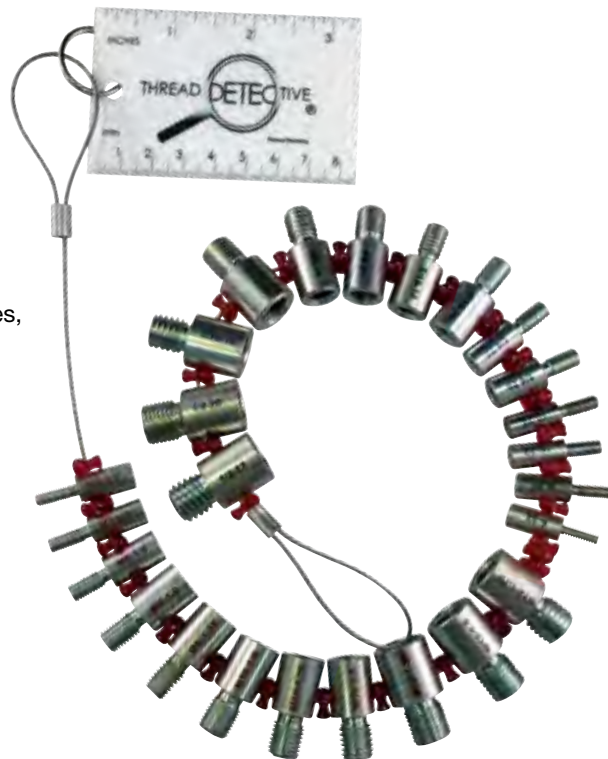

ANTI-FREEZE TESTER VÉRIFICATEUR D'ANTIGEL

No. 263-999

- Tests all ETHYLENE GLYCOL solutions.
- Allows visual inspection for rust and sediment.
- Shows both degrees Fahrenheit and Celsius.
- Individually blister-packed.

Winter Protection

Accurately and quickly indicates the freezing point of radiator solution.

Summer Protection

Indicates boiling point of coolant.



For Battery Tester 570-250
see page 194.

MUFFLER CLAMPS COLLIERS DE SILENCIEUX

256 Series

Papco® Muffler Clamps provide a full 360° seal between muffler and pipes. designed for easier installation and trouble-free service. Assembly consists of heavy gauge saddle, 'U' bolt and two nuts, packed in an individual container.

- Heavy Gauge Steel
- Pipe Size stamped in clamp
- Complete coverage from 1-1/4" to 4" Pipe dia.
- Full depth saddle for extra strength
- Heavy rolled thread 'U' Bolts
- Secure fit between tail pipe and muffler



Use for Inch and Metric applications

Order by Stock Number

| 5/16" diameter 'U' Bolts | | | 3/8" diameter 'U' Bolts | | |
|--------------------------|-----------|-------------|-------------------------|-----------|-------------|
| Stock # | Pipe Size | Metric Eqv. | Stock # | Pipe Size | Metric Eqv. |
| 256-010 | 1-1/4 | 32 mm | 256-114 | 1-3/4 | 45 mm |
| 256-012 | 1-1/2 | 38 mm | 256-115 | 1-7/8 | 48 mm |
| 256-013 | 1-5/8 | 41 mm | 256-116 | 2 | 51 mm |
| 256-014 | 1-3/4 | 45 mm | 256-117 | 2-1/8 | 54 mm |
| 256-015 | 1-7/8 | 48 mm | 256-118 | 2-1/4 | 57 mm |
| 256-016 | 2 | 51 mm | 256-120 | 2-1/2 | 64 mm |
| 256-017 | 2-1/8 | 54 mm | 256-124 | 3 | 76 mm |
| 256-018 | 2-1/4 | 57 mm | 256-128 | 3-1/2 | 89 mm |
| 256-020 | 2-1/2 | 64 mm | 256-132 | 4 | 102 mm |

'SEALTITE' WORM GEAR HOSE CLAMPS COLLIERS DE BOYAUX 'SEALTITE'

307 Series

308 Series

- QUALITY** ■ "301" Stainless Steel Band and Housing. Hi-strength Hex Plated Steel Screw. No loose parts.
- EASY TO USE** ■ Goes on with hose in position. Combination Hex Screw tightens with screw driver or wrench.
- RANGE** ■ Wide size range for each clamp.
- STRENGTH** ■ Wide band for even pressure. Won't cut hose. Full-formed teeth will never slip.



All Stainless Steel for 308 Series

Papco® Sealtite Hose Clamps are manufactured from the highest quality materials for reliable operation in any Automotive or Industrial applications. The aircraft principle of the worm gear drive gives this clamp a powerful sealing action that meets the toughest requirements. Standard clamp features '301' (18.8) Stainless Steel band and housing with a Zinc Plated Steel Screw. The All-Stainless Steel clamp Features a '301' (18.8) Stainless Steel band and housing with a '305' Stainless Steel Screw.

ORDER BY STOCK NUMBER

Standard Package: Contains 10 Hose Clamps

| Stock No. | | Nominal Size | Fits Hose O.D. | Stock No. | | Nominal Size | Fits Hose O.D. |
|-----------|---------------|--------------|----------------|-----------|---------------|--------------|-------------------|
| Standard | All-Stainless | | | Standard | All-Stainless | | |
| 307-001 | 308-001 | 5/16" | 7/32 - 5/8 | 307-032 | 308-032 | 2" | 1-9/16 - 2-1/2" |
| 307-002 | 308-002 | 7/16" | 5/16 - 7/8 | 307-036 | 308-036 | 2-1/4" | 1-13/16 - 2-3/4" |
| 307-008 | 308-008 | 1/2" | 7/16 - 15/16 | 307-040 | 308-040 | 2-1/2" | 2-1/16 - 3" |
| 307-010 | 308-010 | 5/8" | 9/16 - 1-1/16 | 307-044 | 308-044 | 2-3/4" | 2-5/16 - 3-1/4" |
| 307-012 | 308-012 | 3/4" | 5/8 - 1-1/4 | 307-048 | 308-048 | 3" | 2-9/16 - 3-1/2" |
| 307-016 | 308-016 | 1" | 11/16 - 1-1/2 | 307-052 | 308-052 | 3-1/4" | 2-13/16 - 3-3/4" |
| 307-020 | 308-020 | 1-1/4" | 13/16 - 1-3/4 | 307-056 | 308-056 | 3-1/2" | 3-1/16 - 4" |
| 307-024 | 308-024 | 1-1/2" | 1 1/16 - 2 | 307-060 | 308-060 | 3-3/4" | 3-5/16 - 4-1/4" |
| 307-028 | 308-028 | 1-3/4" | 1-5/16 - 2-1/4 | 307-064 | 308-064 | 4" | 3-13/16 - 4-1/16" |

'SNAPPER' HOSE CLAMPS COLLIERS DE BOYAUX 'SNAPPER'

307 Series

Papco® Nylon 6/6 Snapper Hose Clamps form an instant grip on hoses in automobile repair or whenever a quick application is required. Teeth mesh together and are set by using pliers and released by sliding jaws sideways. Will not rust – non-conductive. For pressures up to 120 p.s.i. UV stabilized.

ORDER BY STOCK NUMBER

Standard Package: 10 Clamps

| Stock No. | Fits Hose I.D. | Clamp Range | | Stock No. | Fits Hose I.D. | Clamp Range | |
|-----------|----------------|-------------|---------|-----------|----------------|-------------|----------|
| | | Minimum | Maximum | | | Minimum | Maximum |
| 307-505 | 5/16" | 19/64" | 11/32 | 307-516 | 1" | 63/64" | 1-9/64" |
| 307-506 | 3/8" | 23/64" | 25/64 | 307-517 | 1-1/8" | 1-1/8" | 1-13/64" |
| 307-507 | 7/16" | 13/32" | 29/64 | 307-519 | 1-3/16" | 1-7/32" | 1-19/64" |
| 307-508 | 1/2" | 33/64" | 19/32 | 307-520 | 1-1/4" | 1-9/32" | 1-19/32" |
| 307-509 | 9/16" | 9/16" | 21/32 | 307-522 | 1-1/2" | 1-15/32" | 1-23/32" |
| 307-510 | 5/8" | 39/64" | 45/64 | 307-524 | 1-3/4" | 1-47/64" | 2-1/64" |
| 307-512 | 3/4" | 3/4" | 27/32 | 307-526 | 2" | 2" | 2-15/64" |
| 307-513 | 13/16" | 25/32" | 29/32 | 307-528 | 2-1/4" | 2-1/4" | 2-37/64" |
| 307-514 | 7/8" | 55/64" | 63/64 | | | | |



FUEL INJECTION HOSE CLAMPS COLLIERS DE BOYAUX POUR INJECTEUR D'ESSENCE

Manufactured specifically for all fuel injection applications. Non-perforated band is aluzinc coated carbon steel with a zinc plated carbon steel screw and nut. Band width approximately 3/8".

ORDER BY STOCK NUMBER

Standard Package: 10 Clamps

| Stock No. | Fits Hose I.D. | Clamp Range | | Stock No. | Fits Hose I.D. | Clamp Range | |
|-----------|----------------|-------------|---------|-----------|----------------|-------------|---------|
| | | Minimum | Maximum | | | Minimum | Maximum |
| 307-570 | 1/4" | 7/16" | 1/2" | 307-572 | 3/8" | 9/16" | 5/8" |
| 307-571 | 5/16" | 1/2" | 19/32" | | | | |



GARAGE ASSORTMENT

No. 020-096

Contains 28 Hose Clamps - 3 sizes in a compartmentalized, clear styrene plastic box.



020-096

CONSTANT TENSION HOSE CLAMPS COLLIERS DE BOYAUX A TENSION CONSTANTE

Metal pinch or squeeze type clamp commonly used on fuel, vacuum and other low pressure lines.

ORDER BY STOCK NUMBER

Standard Package: 25 Clamps

| Stock No. | Fits Hose | Max. Clamp | Colour |
|-----------|-----------|------------|--------|
| | O.D. | Dia. Open | |
| 307-560 | 3/8" | .321 | Black |
| 307-561 | 7/16" | .405 | Green |
| 307-562 | 1/2" | .460 | Red |
| 307-564 | 5/8" | .583 | Olive |
| 307-566 | 3/4" | .645 | Black |
| 307-568 | 1" | .910 | Black |



020-097

GARAGE ASSORTMENT

No. 020-097

Contains 55 Clamps - 6 sizes packed in a transparent, plastic container with a hinged lid.

NYLON CABLE CLAMPS COLLIERS DE CABLE NYLON

400 Series

Papco® 6/6 Black Nylon Cable Clamps are tough, resilient, light-weight and highly resistant to wear, most chemicals such as gasoline, oil etc. and destructive U-V rays. Used to secure cables, pipes, tubing, wire etc. in automotive, marine, appliance, commercial and residential applications. All Nylon Clamps provide excellent insulation characteristics.

ORDER BY STOCK NUMBER

| Stock No. | Cable Size | Clamp Width | Standard Package | Stock No. | Cable Size | Clamp Width | Standard Package |
|-----------|------------|-------------|------------------|-----------|------------|-------------|------------------|
| 400-522 | 1/4 | 3/8 | 50 | 400-528 | 5/8 | 1/2 | 25 |
| 400-524 | 3/8 | 3/8 | 50 | 400-530 | 3/4 | 1/2 | 25 |
| 400-526 | 1/2 | 3/8 | 50 | 400-532 | 1 | 1/2 | 15 |



GARAGE ASSORTMENT

No. 020-088

Contains 40 pieces - 6 sizes of Nylon Cable Clamps listed above. Packed in a sturdy, clear, plastic box.



020-088







NOTE: For a complete listing of clamps, please refer to our current *Dominion Fittings Fluid Flow Components Catalogue*.

**PUSH-PULL CONTROLS
CABLES DE CONTRÔLE**

310
Series

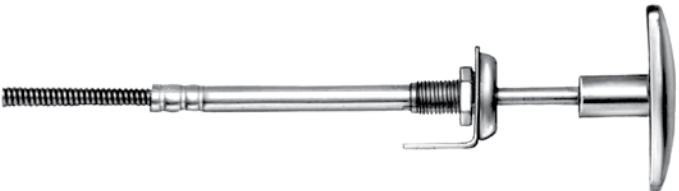
For choke, throttle, hood, air vents, heater valves, mowers, snow blowers, power take-off etc. All controls are individually packaged for point of sale display.

ORDER BY STOCK NUMBER

| Stock No. | Length | Description | |
|-----------|-----------|---|--|
| 310-120 | 60" long | Utility Controls Round black knob to complete any dash panel. 2" travel, 3/16 OD. Gal. Casing, .054" HC Wire, 3/8-24 housing thread |  |
| 310-121 | 72" long | | |
| 310-136 | 180" long | Standard Assembly Round lustrous black knob. Includes mounting bracket and finishing washer plated. 2" travel, 3/16 OD. Casing, .054" HC Wire, 3/8-24 housing thread |  |
| 310-152 | 84" long | 'T' handle Assembly Chrome plated metal handle. Plated assembly. Includes mounting bracket and finishing washer. 2" travel, 3/16 OD. Casing, .054" HC Wire, 3/8-24 housing thread |  |
| 310-173 | 108" long | 'T' handle Heavy Duty Locking Assembly Locks with half turn. Brass Clutch. Chrome Handle. Includes dash mount bracket and finishing washer. Full floating core does not turn with handle. 2" travel, 3/16 OD. Casing, .062" HC Wire, 3/8-24 housing thread |  |
| 310-181 | 72" long | T handle Heavy Duty Locking Assembly Turn and lock. Brass locking clutch. Chrome Handle. Plated. Heavy Duty Housing with 2" thread length. Full floating core wire. 2" travel, 3/16 OD. Casing, .062" HC Core Wire, 1/2-20 housing thread |  |
| 310-183 | 108" long | Marine Control For boats, other marine and hostile environment applications. Casing is 3/16" Dia. REINFORCED Nylon. 'T' Handle is chrome plated. Brass housing. Full floating core wire. 2" travel, 3/16" Vinyl Coated casing w/HDPE Liner, .062" Stainless Core Wire, 3/8-24 housing thread. |  |
| 310-194 | 120" long | Power Take Off Controls Used primarily as dash mounted power takeoff control on trucks and mobile equipment. Nylon lined, metal reinforced vinyl casing. Plated for corrosion resistance. Large 2" Dia. round plastic knob. 7/16-20 x 1-1/2" long housing. Includes mounting nut and lock washer. Individually boxed. |  |
| 310-198 | 240" long | 4" travel, 5/16" Vinyl Coated Casing, .093" Stainless Core Wire, 7/16-20 housing thread | |

HEAVY DUTY VERNIER CONTROL CONTRÔLE VERNIER EXTRA-ROBUSTE

310
Series

Recommended for heavy truck, bus, agricultural and off-highway uses. Heavy duty easy-action control for critical adjustments. This accurate Vernier Control has a unique three prong locking collar. Designed for one-hand setting and locking in place. Make accurate fine adjustments by rotating knob - depress central button and push or pull for coarse setting.

Long life working parts are brass and stainless, weather resistant 5/16" O.D. reinforced vinyl casing and liner, .072" stainless steel core wire x 120" long. Housing is 3/4-16 x 2-9/16" long with hex panel nut, mounting nut and lock washer. Travel is 3-5/8".

No. 310-216
120" long, individually boxed.

310-216



CHOKE CONVERSION KITS TROUSSES DES CONVERSION A L'ÉTRANGLEUR

Helps eliminate hard winter starts. Allows driver to control choke. Instant control of air and gas mixture from dash. Order by stock number. Complete instructions included. Individually packaged.

SEMI-AUTOMATIC TYPE

No. 310-245

Allows manual override. Exclusive "Magic-Link" lets engine breathe even under full choke. Fits AMC, GM, Ford and Chrysler cars. 60" cable.

No. 310-246

Fits all light and medium domestic trucks. Has long 108" cable.

COMPLETE MANUAL OPERATION TYPE

No. 310-250

Universal kit. For most domestic made cars. Cable is 60" long.

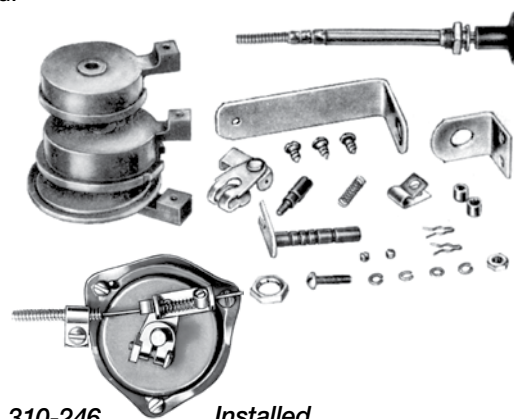

310-246

Installed

UNIVERSAL SPEEDOMETER CABLE KIT TROUSSE DE CABLE POUR INDICATEUR DE VITESSE

This complete kit includes 81" long standard multi-strand flexible shafting with .104" squared lower end. Cut shafting to length of original speedometer cable and attach the square tip with the staking tool provided. Fits most cars, trucks and RV's.

No. 310-281

Individually Packaged
81" Flexible shafting, tip and tool.

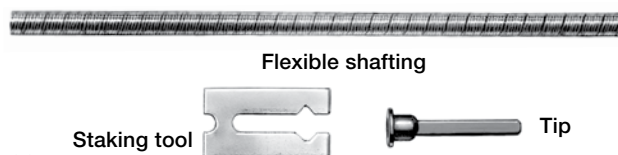

310-281

CONTROL WIRE STOPS BLOQUEURS POUR CONTRÔLE DE BROCH

Universal type. For push-pull controls, choke control wires, hood release latches and throttle cables. Position cable stop against control arm of lever and tighten screw. Order by stock number. Standard package 25 pieces.

No. 310-353

1/4" for 1-16" wire.

310-353



No. 310-354

3/8" for 1/8" wire.

310-354



**CARBURETOR AND THROTTLE RETURN SPRINGS
RESSORTS DE CARBURATEUR ET SOUPEPE DE RÉGLAGE**

ORDER BY STOCK NUMBER

Standard Package: Contains 12 Springs

| Stock No. | Description | |
|-----------|--|--|
| 311-001 | Universal Throttle Return Spring. Can be adapted for use on all carburetor and accelerator pedals. Spring measures 12" overall and plain end can be cut to required length. |  |
| 311-002 | Carburetor Return Spring. Attach to screw on carburetor body and hook to throttle valve arm. Acts as a helper spring for throttle return - prevents racing and sticking accelerator. For G.M. and Chrysler cars. |  |

**CARBURETOR SPRING DISPLAY
ASSORTIMENT RESSORT DE CARBURATEUR**

No. 020-878

Contains 12 each No. 311-001, No. 311-002 Springs mounted on attractive three colour merchandising display card.

020-878



**UNIVERSAL PEDAL RETURN SPRINGS
RESSORTS REVENIR DE PÉDALE UNIVERSEL**

FOR ALL BRAKE AND CLUTCH PEDALS

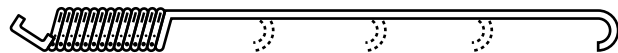

No. 311-101

18-1/2" overall x 13/16" O.D. x 2" Coil x 7/64" Dia. wire.

311-101



No. 311-103

18-1/2" overall x 3/4" O.D. x 3-1/2" Coil x 1/16" Dia. wire.

311-103

Standard Package 12 Springs

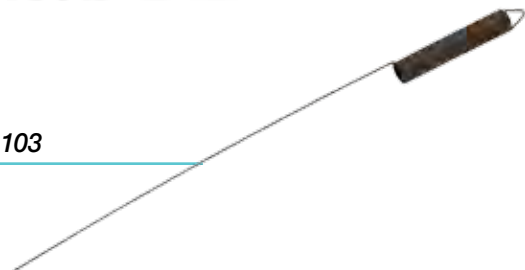

UTILITY SPRINGS RESSORTS D'UTILITÉ

311
Series

COMPRESSION TYPE / EXTENSION TYPE

In sizes suitable for most requirements

COMPRESSION TYPE



ORDER BY STOCK NUMBER

Standard Package: 12 Pieces

| Stock No. | Outside Dia. | Length | Wire Size | Stock No. | Outside Dia. | Length | Wire Size |
|-----------|--------------|--------|-----------|-----------|--------------|---------|-----------|
| 311-639 | 3/32" | 7/8" | .020" | 311-601 | 3/8" | 11-1/2" | .051" |
| 311-676 | 3/16" | 5" | .026" | 311-655 | 7/16" | 2-3/4" | .045" |
| 311-615 | 1/4" | 1-1/2" | .041" | 311-622 | 7/16" | 3" | .062" |
| 311-677 | 1/4" | 5" | .034" | 311-682 | 7/16" | 5" | .062" |
| 311-618 | 9/32" | 2" | .022" | 311-683 | 1/2" | 5" | .072" |
| 311-678 | 5/16" | 5" | .047" | 311-620 | 5/8" | 2-1/2" | .081" |
| 311-679 | 5/16" | 5" | .054" | 311-646 | 5/8" | 3" | .062" |
| 311-656 | 3/8" | 2" | .034" | 311-653 | 5/8" | 3-3/8" | .080" |
| 311-650 | 3/8" | 2-3/4" | .045" | 311-602 | 5/8" | 11-1/2" | .057" |
| 311-680 | 3/8" | 5" | .054" | 311-603 | 7/8" | 10" | .081" |
| 311-681 | 3/8" | 5" | .062" | | | | |

EXTENSION TYPE



ORDER BY STOCK NUMBER

Standard Package: 12 Pieces

| Stock No. | Outside Dia. | Length | Wire Size | Stock No. | Outside Dia. | Length | Wire Size |
|-----------|--------------|--------|-----------|-----------|--------------|--------|-----------|
| 311-633 | 1/8" | 9/16" | .018" | 311-630 | 5/16" | 5-3/8" | .041" |
| 311-684 | 1/8" | 15/16" | .020" | 311-608 | 5/16" | 6" | .034" |
| 311-634 | 1/8" | 1-3/8" | .018" | 311-659 | 5/16" | 6-3/4" | .034" |
| 311-612 | 5/32" | 2-1/8" | .028" | 311-658 | 5/16" | 7-1/4" | .045" |
| 311-636 | 3/16" | 1-1/8" | .025" | 311-610 | 11/32" | 3" | .041" |
| 311-616 | 3/16" | 1-1/4" | .014" | 311-685 | 3/8" | 1-7/8" | .031" |
| 311-623 | 3/16" | 2-1/2" | .028" | 311-629 | 3/8" | 4-3/4" | .045" |
| 311-627 | 7/32" | 2-1/4" | .034" | 311-631 | 3/8" | 11" | .054" |
| 311-617 | 1/4" | 1-1/8" | .020" | 311-626 | 7/16" | 3-1/8" | .041" |
| 311-624 | 1/4" | 3-3/4" | .034" | 311-606 | 7/16" | 5" | .062" |
| 311-609 | 1/4" | 4" | .028" | 311-661 | 7/16" | 6-3/8" | .054" |
| 311-607 | 1/4" | 5-3/4" | .028" | 311-605 | 7/16" | 6-1/2" | .041" |
| 311-635 | 9/32" | 1-1/8" | .020" | 311-611 | 1/2" | 4-1/2" | .062" |
| 311-628 | 9/32" | 1-7/8" | .034" | 311-604 | 1/2" | 5-1/2" | .080" |
| 311-625 | 5/16" | 2-1/2" | .034" | 311-632 | 1/2" | 11" | .062" |

**UTILITY SPRING ASSORTMENTS
ASSORTIMENTS DE RESSORT D'UTILITÉ**

GARAGE ASSORTMENT

No. 020-063

Contains 100 Small Coil Springs. Compression and Extension types included. Packed in plastic box.

020-063



UTILITY ASSORTMENT

No. 020-342

Contains 83 Extension and Compression Springs
15 Popular Sizes.
Packed in a sturdy fibreboard container.

020-342



MASTER ASSORTMENT

No. 020-637

Contains 135 Utility Springs, consisting of Compression, Extension and Ignition Springs. With this Assortment you will find a spring suitable for most any replacement. The attractive label shows the dimensions, stock number and list price of each spring. Refills may be ordered from standard stock.

Assortment is packed in a sturdy, sectional metal container complete with self-locking handle.

020-637



EXTENSION SPRING ASSORTMENT

No. 020-860

Contains 30 Extension Springs. 12 popular sizes.

020-860



COMPRESSION SPRING ASSORTMENT

No. 020-861

Contains 40 Compression Springs. 12 popular sizes.

020-861



BRASS SHIM STOCK FEUILLES POUR CALE LAITON

305
Series

Papco[®] Brass Shim Stock is uniform and accurate in thickness, hard temper and is ideal for cutting and shaping. The 6" wide x 100" long rolls are supplied in fibre dispenser tubes for easy use.

ORDER BY STOCK NUMBER

| Stock No. | Thickness | Stock No. | Thickness |
|------------------------|-----------|-----------|-----------|
| 100 Inch Strips | | | |
| 305-601 | .001 | 305-608 | .008 |
| 305-602 | .002 | 305-609 | .009 |
| 305-603 | .003 | 305-610 | .010 |
| 305-604 | .004 | 305-612 | .012 |
| 305-605 | .005 | 305-615 | .015 |
| 305-606 | .006 | 305-620 | .020 |
| 305-607 | .007 | 305-625 | .025 |



STEEL SHIM STOCK FEUILLES POUR CALE ACIER

305
Series

Papco[®] Steel Shim Stock is hard shim temper and uniform in thickness. Supplied in strips 100 inches long by 6 inches wide as listed. Each strip is packed in a sturdy fibre tube.

ORDER BY STOCK NUMBER

| Stock No. | Thickness | Stock No. | Thickness | Stock No. | Thickness | Stock No. | Thickness |
|-----------------------------|-----------|-----------|-----------|-----------|-----------|-----------|-----------|
| 6" Wide by 100" Long | | | | | | | |
| 306-601 | .001 | 306-604 | .004 | 306-607 | .007 | 306-612 | .012 |
| 306-602 | .002 | 306-605 | .005 | 306-608 | .008 | 306-615 | .015 |
| 306-603 | .003 | 306-606 | .006 | 306-610 | .010 | 306-620 | .020 |

Note: Stainless Steel Shim Stock available – price on application.



SNAP FASTENERS ATTACHES 'SNAP'

400
Series

Durable Fasteners

Papco® Snap Fasteners provide superior snap action and holding strength. Snap Fasteners are self-piercing and made of heavy duty, nickel plated brass. Used in a variety of materials on boats, tents, sporting goods, RV's, luggage, awnings, clothing - camper, convertible and tonneau tops.

ORDER BY STOCK NUMBER

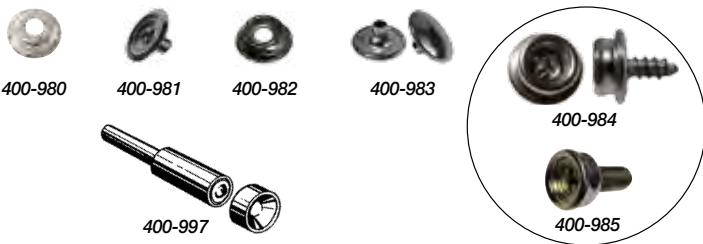
| Stock No. | Description | Standard Package |  | | | | |
|-----------|----------------------------|------------------|--|---------|---------|---------|---------|
| 400-980 | 3/8 Socket - Normal Action | 25 | 400-980 | 400-981 | 400-982 | 400-983 | 400-984 |
| 400-981 | 3/8 Post - 10 mm dia. | 25 | | | | | |
| 400-982 | 3/8 Stud | 25 | | | | | |
| 400-983 | 3/8 Cap 24 mm dia. | 25 | | | | | |
| 400-984 | 3/8 Screw Stud No. 8 | 25 | | | | | |
| 400-985 | 3/8 Bolt Stud 10-32 | 25 | | | | | |
| 400-997 | Installation Tool | 1 | | | | | |

'LIFT-THE-DOT' FASTENERS ATTACHES 'LIFT-THE-DOT'

Strong, heavy duty fasteners that lock on 3 sides. Opened by lifting the fourth side where the dot and trademark appear.

ORDER BY STOCK NUMBER

| Stock No. | Description | Standard Package |  | | | | |
|-----------|-----------------------|------------------|--|---------|---------|---------|---------|
| 400-900 | No. 8 Wood Screw Stud | 25 | 400-903 | 400-913 | 400-900 | 400-902 | 400-904 |
| 400-902 | Stud | 25 | | | | | |
| 400-903 | Socket | 25 | | | | | |
| 400-904 | Washer | 25 | | | | | |
| 400-913 | Back Plate | 25 | | | | | |

TURN FASTENERS ATTACHES TOURNANTES

Also known as Common Sense Fasteners

Papco® Turn Fasteners are positive locking and never open accidentally. Spring mechanism contained in stud holds fastener under tension until turned by hand.

ORDER BY STOCK NUMBER

| Stock No. | Description | Standard Package |  | | | | |
|-----------|-------------|------------------|--|---------|---------|---------|---------|
| 400-901 | Turn Button | 10 | 400-912 | 400-911 | 400-901 | 400-905 | 400-910 |
| 400-905 | Back Plate | 25 | | | | | |
| 400-910 | Turn Button | 10 | | | | | |
| 400-911 | Washer | 25 | | | | | |
| 400-912 | Grommet | 25 | | | | | |

GARAGE ASSORTMENT

No. 020-091

Contains 25 pieces including installation tool of the most popular Snap Fasteners packed in a sturdy, transparent box.

No. 020-092

Contains 20 pieces of Lift-the-Dot[®] Fasteners in a clear, compartmentalized plastic box.

No. 020-093

Contains 20 pieces of Papco[®] Turn Fasteners packed in a clear, plastic container with hinged lid.

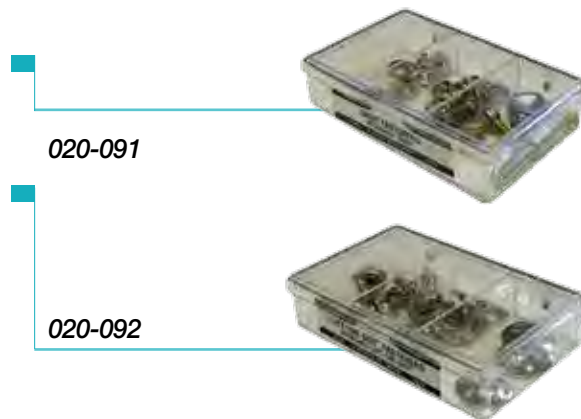

BRASS GROMMETS BAGUES EN LATION

400
Series

Solid Brass, tooth type grommets are recommended for extra holding power and corrosion resistance. Use grommets on tents, tarpaulins, trucks, sails, awnings, boat covers, pool covers, lawn furniture etc. Available in two sizes: No. 400-958 3/8" I.D. and No. 400-960 1/2" I.D. Order by stock number. Standard package 10 pieces per bag.

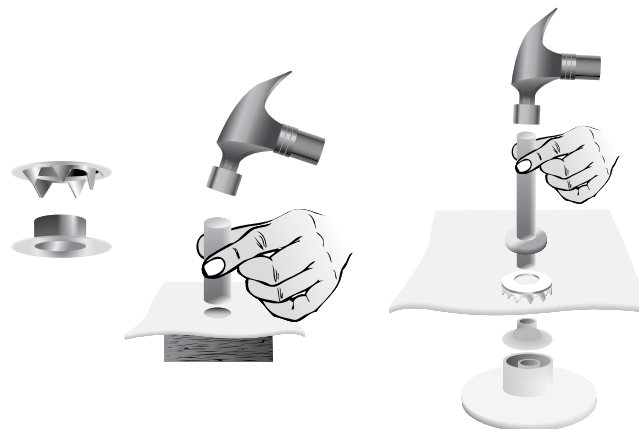

3/8" GROMMET KIT

No. 400-968

Consists of hole punch, flaring punch and anvil base. Includes 10 solid Brass 3/8" grommets with tooth type washers. Packed with instructions in a re-usable hang-up vinyl pouch. Professional quality tool kit.



1/2" GROMMET KIT

No. 400-970

Professional setting tool and ten 1/2" grommets as above.



**CERAMIC MAGNETS
AIMANTS CÉRAMIQUES**

Papco[®] High Strength Ceramic Magnets are ideal for temporary attachment of metal panels, work orders or masking material without damaging painted areas or other metal surfaces.

CERAMIC BLOCK MAGNETS

| Stock No. | Width | Length | Height | Package |
|-----------|-------|--------|--------|---------|
| 400-002 | 7/8 | 1-7/8 | 3/8 | 2 |

400-002



CERAMIC DISC MAGNETS

| Stock No. | Diameter | Height | Package |
|-----------|----------|--------|---------|
| 400-004 | 1/2 | 3/16 | 10 |
| 400-005 | 3/4 | 3/8 | 8 |

400-005



**MAGNETIC STRIP
BANDE AIMANTE**

No. 400-010

Flexible, Magnetic Strip with adhesive back, cuts easily with scissors or a knife. Magnetic surface of strip holds small metal objects. Ideal for Body Shops for holding plastic masking material or work orders to vehicle body areas without damaging painted surfaces. Perfect for mounting signs.

Size: 1/2" wide x 10 feet long. Order by stock number.

400-010



**LIFTING MAGNET (HEAVY DUTY)
AIMANT RÉCUPÉRATEUR (USAGE INTENSE)**

USAGE INTENSE

No. 400-020

For commercial, recreational or household use. Ideal for removing dents in metal. Retrieve submerged tools, metal parts, tackle, fishing poles etc. Locate, lift, hold or hang steel articles. Order by stock number.

Individually packaged.

Lifts up to 150 lbs

400-020

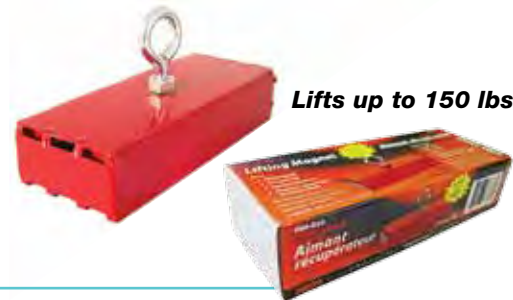

**TOOL MAGNETIZER / DEMAGNETIZER
OUTIL À AIMANTER / DÉ-AIMANTER**

No. 400-022

Easy-to-use tool magnetizes screwdrivers, wrenches and other small tools. Pass tool through centre hole of charger to magnetize. To demagnetize pass tool over outside edge of charger several times. Order by stock number.

400-022

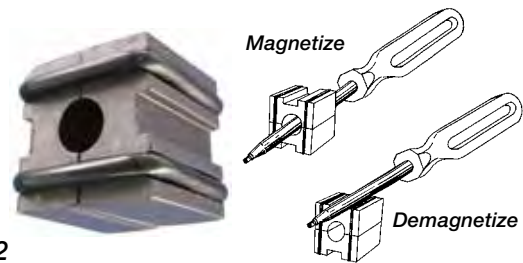

**MAGNETIC RETRIEVER
RAMASSE-PIÈCES AIMANTE**

No. 400-024

This chrome plated, telescopic tool has a powerful, permanent NEODYMIUM magnetic tip that will lift over 3.5 pounds. The retriever can be used to pick-up steel objects, dropped tools, fasteners etc. from hard-to-reach places. Six inches long with a handy pocket clip, extends to over 24". Can also be used as a presentation pointer. Order by stock number. Individually carded.

400-024



VACUUM CONNECTORS RACCORDS À DÉPRESSION

904 Series

Papco® Plastic Fittings are designed for quick, easy, inexpensive installations of vacuum lines, windshield washer lines and any other low pressure systems using air or fluids. Can be used with all flexible plastic tubing. Not recommended for fuel line applications.

ORDER BY STOCK NUMBER

Nylon Straight Connector



| Stock No. | Tube Size |
|-----------|-------------|
| 904-901 | 1/8 x 1/8 |
| 904-902 | 3/16 x 3/16 |
| 904-903 | 1/4 x 1/4 |
| 904-904 | 5/16 x 5/16 |
| 904-905 | 3/8 x 3/8 |

Nylon Reducing Straight Connector



| Stock No. | Tube Size |
|-----------|------------|
| 904-911 | 1/8 x 3/16 |
| 904-912 | 1/8 x 1/4 |
| 904-913 | 3/16 x 1/4 |
| 904-914 | 1/4 x 3/8 |

Nylon Restrictor Connector



| Stock No. | Tube Size |
|-----------|-------------|
| 940-920 | 3/16 x 3/16 |

Nylon 3 Way Tee

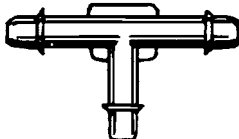

| Stock No. | Tube Size |
|-----------|--------------------|
| 904-922 | 1/8 x 1/8 x 1/8 |
| 904-923 | 3/16 x 3/16 x 3/16 |
| 904-924 | 1/4 x 1/4 x 1/4 |
| 904-925 | 5/16 x 5/16 x 5/16 |
| 904-926 | 3/8 x 3/8 x 3/8 |

Nylon 3 Way Reducing Tee

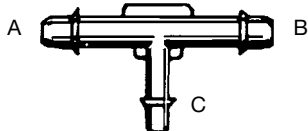

| Stock No. | Tube Size 'A' x 'B' x 'C' |
|-----------|---------------------------|
| 904-929 | 1/8 x 1/8 x 3/16 |
| 904-930 | 1/8 x 1/8 x 1/4 |
| 904-931 | 3/16 x 1/8 x 3/16 |
| 904-932 | 3/16 x 1/4 x 3/16 |
| 904-933 | 3/16 x 3/16 x 1/8 |
| 904-934 | 1/4 x 3/16 x 3/16 |
| 904-938* | 1/4 x 3/8 x 3/8 |
| 904-939 | 3/8 x 3/8 x 1/4 |

*PCV Connector

Nylon 'Y' Connector

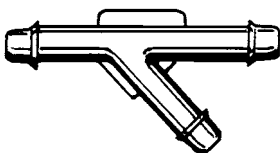

| Stock No. | Tube Size |
|-----------|--------------------|
| 904-940 | 1/8 x 1/8 x 1/8 |
| 904-941 | 3/16 x 3/16 x 3/16 |
| 904-942 | 1/4 x 1/4 x 1/4 |
| 904-943 | 5/16 x 5/16 x 5/16 |

Nylon Reducing 'Y' Connector

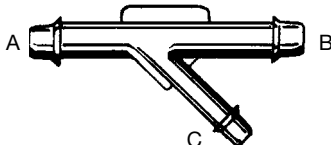

| Stock No. | Tube Size 'A' x 'B' x 'C' |
|-----------|---------------------------|
| 904-944 | 1/4 x 1/4 x 3/16 |

Nylon 90° Elbow

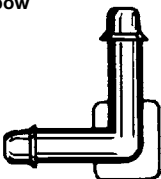

| Stock No. | Tube Size x Pipe Size |
|-----------|-----------------------|
| 940-950 | 1/8 x 1/8 |
| 940-951 | 3/16 x 3/16 |
| 940-952 | 1/4 x 1/4 |
| 940-953 | 5/16 x 5/16 |

Nylon 4 Way Connector

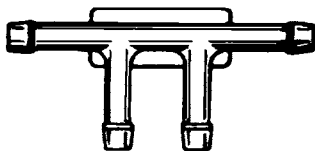

| Stock No. | Tube Size |
|-----------|-----------|
| 904-960 | 3/16 |

Nylon 5 Way Connector

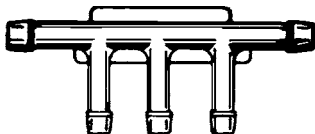

| Stock No. | Tube Size |
|-----------|-----------|
| 904-965 | 3/16 |

Standard Package: 25 Pieces

ABS Plastic Universal Tee

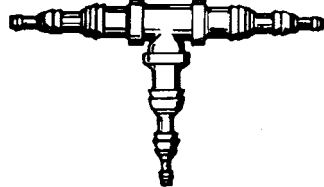

| Stock No. | Tube Size |
|-----------|--------------------|
| 904-975 | 5/32 to 1/4 to 3/8 |

ABS Plastic Universal Straight Connector



| Stock No. | Tube size |
|-----------|--------------------|
| 904-976 | 5/32 to 1/4 to 3/8 |

Vacuum Caps



| Stock No. | Hose Size |
|-----------|-----------|
| 904-990 | 1/8 |
| 904-991 | 3/16 |
| 904-992 | 1/4 |
| 904-993 | 5/16 |
| 904-994 | 3/8 |

Soft Rubber Vacuum Tee



| Stock No. | Hose Size |
|-----------|--------------------|
| 904-985 | 7/64 x 7/67 x 7/64 |

Soft Rubber Vacuum Connectors

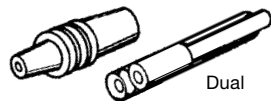

| Stock No. | Tube Size |
|-----------|------------|
| 904-986 | 5/32 Dual |
| 904-987 | 1/8 x 5/32 |

Soft Rubber Vacuum Elbow and Hose

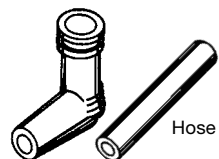

| Stock No. | Hose Size |
|-----------|----------------|
| 904-988 | 5/32 x 3/16 |
| 904-989 | 5/32 x 2" Hose |

For **MASTER ASSORTMENT** No. 020-605 of Vacuum Connectors please refer to page 7.

**TAPS & DIES
TARAUDS & FILIÈRES**

Papco[®] Taps and Dies are made of high carbon tool Steel, heat treated to industrial specifications and packed in colour-coded, protective packs. Long-life, plug type taps are chamfered for easy starting and cut clean accurate threads. Hexagon dies in sizes to 1/2" and M12 are 1" across flats - larger sizes are 1-7/16" across flats. Use Die Stock No. 996-563 or wrench for driving dies. Papco[®] Taps and Dies are available in NC (National Coarse), NF (National Fine); Metric Standard, Fine and Extra Fine thread pitch - plus N.P.T. (National Pipe Thread) and B.S.P. (British Standard Pipe) for fittings on Import vehicles. Tap and drill sizes are engraved on each tap - starting side and size engraved on dies.

**HIGH CARBON STEEL
INDUSTRIAL GRADE
TAPS AND DIES**

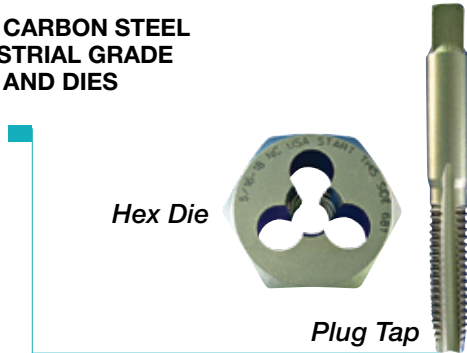

Hex Die

Plug Tap

MERCHANDISERS

- Nos. 022-108**
- 022-109**
- 022-110**



NC/NF MERCHANDISER

No. 022-108

As illustrated. Contains one each of 1/4 to 1/2 Coarse and Fine Thread Taps and Dies - 20 sizes. Includes wire rack, header sign and label strips.

METRIC MERCHANDISER

No. 022-109

Contains one each of all listed sizes of Metric Standard, Fine and Extra Fine thread pitch Taps and Dies - 18 sizes. Includes wire rack, header sign and label strips.

MERCHANDISER

No. 022-110

Contains one each of NPT and BSP Taps and Dies, No. 1 to 5 Screw Extractors, Screw Extractor Set, Inch and Metric Thread Pitch Gauges and a professional Tap and Reamer Wrench. Includes pegboard hooks, header sign and planogram.

PAPCO[®] HIGH CARBON STEEL, PLUG TYPE TAPS

ORDER BY STOCK NUMBER

Individually Packaged

| 022-108 | | | | | | 022-109 | | | 022-110 | | |
|--------------------|---------|-------|------------------|---------|-------|-----------|--------------|-------|-----------|------------|-------|
| Stock No. | Size | Drill | Stock No. | Size | Drill | Stock No. | Size | Drill | Stock No. | Size | Drill |
| NC National Coarse | | | NF National Fine | | | Metric | | | Pipe | | |
| 996-010 | 10-24 | 5/32 | 996-110 | 10-32 | 5/32 | 996-204 | M4 x .7 | 1/8 | 996-250 | 1/8-27 NPT | 11/32 |
| 996-014 | 1/4-20 | 13/64 | 996-114 | 1/4-28 | 7/32 | 996-205 | M5 x .8 | 11/64 | 996-252 | 1/4-18 NPT | 7/16 |
| 996-016 | 5/16-18 | 17/64 | 996-116 | 5/16-24 | 17/64 | 996-206 | M6 x 1.0 | 13/64 | 996-254 | 3/8-18 NPT | 37/64 |
| 996-018 | 3/8-16 | 5/16 | 996-118 | 3/8-24 | 21/64 | 996-208 | M8 x 1.25 | 17/64 | 996-256 | 1/2-14 NPT | 23/32 |
| 996-020 | 7/16-14 | 3/8 | 996-120 | 7/16-20 | 25/64 | 996-210 | M10 x 1.5 | 11/32 | 996-257 | 1/8-28 BS | 5/16 |
| 996-022 | 1/2-13 | 27/64 | 996-122 | 1/2-20 | 29/64 | 996-212 | M12 x 1.75 | 27/64 | | | |
| | | | | | | 996-230 | M8 x 1.0 F | 9/32 | | | |
| | | | | | | 996-231 | M10 x 1.25 F | 11/32 | | | |
| | | | | | | 996-232 | M12 x 1.5 F | 13/32 | | | |
| | | | | | | 996-240 | M10 x 1.0 XF | 23/64 | | | |

F - Fine Thread Pitch
XF - Extra Fine Thread (Spark Plug)

PAPCO[®] HIGH CARBON STEEL, HEXAGON DIES (1 AF)

ORDER BY STOCK NUMBER

Individually Packaged

| 022-108 | | | | 022-109 | | 022-110 | |
|--------------------|---------|------------------|---------|-----------|---------------|-----------|--------------------------------|
| Stock No. | Size | Stock No. | Size | Stock No. | Size | Stock No. | Size |
| NC National Coarse | | NF National Fine | | Metric | | Pipe | |
| 996-314 | 1/4-20 | 996-414 | 1/4-28 | 996-505 | M5 x .8 | 996-540 | 1/8-27 NPT |
| 996-316 | 5/16-18 | 996-416 | 5/16-24 | 996-506 | M6 x 1.0 | 996-542 | 1/4-18 NPT |
| 996-318 | 3/8-16 | 996-418 | 3/8-24 | 996-508 | M8 x 1.25 | 996-547 | 1/8-28 NPT |
| 996-320 | 7/16-14 | 996-420 | 7/16-20 | 996-510 | M10 x 1.5 | 996-550 | Screw Extractor Set |
| 996-322 | 1/2-13 | 996-422 | 1/2-20 | 996-512 | M12 x 1.75 | 996-551 | Straight Flute Screw Extractor |
| | | | | 996-530 | M8 x 1.0 F | 996-552 | Straight Flute Screw Extractor |
| | | | | 996-531 | M10 x 1.25 XF | 996-553 | Straight Flute Screw Extractor |
| | | | | 996-532 | M12 x 1.5 F | 996-554 | Straight Flute Screw Extractor |
| | | | | | | 996-555 | Straight Flute Screw Extractor |
| | | | | | | 996-570 | Inch Screw Pitch Gauge |
| | | | | | | 996-571 | Metric Screw |

(* 1-7/16 AF)
F - Fine Thread Pitch

THREAD CUTTING TOOLS AND MERCHANDISERS PRÉSENTOIRS ET OUTILS AUTO-TARAUDEUSES

SCREW EXTRACTORS

These chrome-vanadium straight flute extractors are heat treated to give the highest torque specification and may be used with any wrench. Straight tapered flute will not expand the screw or stud being removed. Drill size engraved on each individually packed extractor.

ORDER BY STOCK NUMBER

| Stock No. | Size | Fits Screw Dia. | Use Drill |
|-----------|--------|-----------------------------|-----------|
| 996-551 | No. 1 | 1/4, 5/16, M6, M8 | 1/8 |
| 996-552 | No. 2 | 3/8, M10, 1/8-27, 1/8-28 | 3/16 |
| 996-553 | No. 3* | 7/16, M12 | 15/64 |
| 996-554 | No. 4 | 1/2, 9/16, M14, 1/4-18 | 5/16 |
| 996-555 | No. 5 | 5/8, M16, 3/8-18 | 3/8 |

*Use for broken Grease Fittings



SCREW EXTRACTORS SET

No. 996-550

Consists of five extractors
- One each of No. 1 to 5
as listed above.



996-550

TOOLS OUTILS

'T'- HANDLE TAP WRENCH

No. 996-560

Fits taps from No. 0 to 1/4"
and features adjustable,
self-equalizing wrench
jaws. Handle is held in
place by spring tension.
Individually carded.



996-560

'T'- HANDLE TAP WRENCH

No. 996-561

Fits 1/4" to 1/2"
taps. Features a removable
handle-plus a 3/8"
female square drive for
extensions or ratchet
drive. Individually carded.



996-561

PROFESSIONAL TAP WRENCH

No. 996-562

Fits taps from M4 to 1/2".
Industrial quality tool is
used for taps, reamers
and screw extractors.
Adjustable, hardened jaws
tighten by turning handles.
Individually carded.



996-562

DIE STOCK

No. 996-563

Professional Die Holder
fits 1" hexagon or round
dies up to 1/2" or M12.
Has three jaw, self-
centering, adjustable
guides for easy starting
and accurate threading.
Chrome plated handles.
Individually carded.



996-563

SCREW PITCH GAUGES

No. 996-570 (Inch)

For inch threads. 14 blades for threads from 10 to 40 per inch. Individually packaged. (Inch 'pitch' is the number of threads per inch T.P.I.)

No. 996-571 (Metric)

For metric threads. 14 blades for pitches from 0.45 to 2.50 mm. Individually packaged. (Metric 'pitch' is the distance between threads.)



996-570



996-571

HIGH SPEED STEEL INDUSTRIAL GRADE DRILL BITS FORETS ACIER RAPIDE QUALITÉ INDUSTRIELS

These jobber length high speed tool steel drill bits feature a ground body and polished flutes for fast chip removal. Suitable for drilling steel, wood and plastic. Bits are packaged on bar-coded hang-up cards individually (* 2 bits).

DRILL BIT MERCHANDISER

No. 022-115

Contains each of the 29 sizes of drill bits from 1/16" to 1/2" by 64th., including 3/8" reduced shanks, 1/4" to 1/2" Masonry Bits - and 1/8" double-ended panel drills. A total of 82 cards including an attractive header sign and merchandising rack suitable for wall, pegboard, counter, or gondola display.

1/8" DOUBLE ENDED PANEL DRILL

No. 997-594

High speed ground steel with special 135° split point. Made for body panel work. Starts cutting on contact, won't wander, no centre punch required. 1/8" Dia. x 2" long double-ended. Packed 5 bits per pouch.



022-115

997-120



997-594



ORDER BY STOCK NUMBER

| Stock No. | Diameter | Length Overall | Stock No. | Diameter | Length Overall | Stock No. | Diameter | Length Overall |
|-------------------------|----------|----------------|-------------------------|----------|----------------|------------------------------|----------|----------------|
| High Speed Steel Drills | | | High Speed Steel Drills | | | High Speed Steel Drills | | |
| 997-104* | 1/16 | 1-7/8 | 997-117 | 17/64 | 4-1/8 | 997-130† | 15/32 | 5-3/4 |
| 997-105* | 5/64 | 2 | 997-118 | 9/32 | 4-1/4 | 997-131† | 31/64 | 5-7/8 |
| 997-106* | 3/32 | 2-1/4 | 997-119 | 19/64 | 4-3/8 | 997-132† | 1/2 | 6 |
| 997-107* | 7/64 | 2-5/8 | 997-120 | 5/16 | 4-1/2 | Masonry Drills - Carbide Tip | | |
| 997-108* | 1/8 | 2-3/4 | 997-121 | 21/64 | 4-5/8 | 997-586 | 3/16 | 3-3/8 |
| 997-109 | 9/64 | 2-7/8 | 997-122 | 11/32 | 4-3/4 | 997-587 | 1/4 | 4 |
| 997-110 | 5/32 | 3-1/8 | 997-123 | 23/64 | 4-7/8 | 997-588 | 5/16 | 4-3/4 |
| 997-111 | 11/64 | 3-1/4 | 997-124 | 3/8 | 5 | 997-589 | 3/8 | 4-3/4 |
| 997-112 | 3/16 | 3-1/2 | 997-125† | 25/64 | 5-1/8 | 997-590† | 1/2 | 5-7/8 |
| 997-113 | 13/64 | 3-5/8 | 997-126† | 13/32 | 5-1/4 | 997-591† | 5/8 | 6 |
| 997-114 | 7/32 | 3-3/4 | 997-127† | 27/64 | 5-3/8 | 997-592† | 3/4 | 6 |
| 997-115 | 15/64 | 3-7/8 | 997-128† | 7/16 | 5-1/2 | | | |
| 997-116 | 1/4 | 4 | 997-129† | 29/64 | 5-5/8 | | | |

* These sizes 2 bits Per card.

† 3/8 Reduced Shank

**DRILL SETS
JEU DE FORETS**

HIGH SPEED STEEL INDUSTRIAL GRADE DRILL BITS



A No. 020-907

4 Pieces – 1/16, 1/8, 3/16, 1/4 H.S.S. 'Pic-a-drill' clear vinyl pouch. The 4 most popular drill sizes. Ideal as a basic kit or to replace worn drills in larger sets.

B No. 020-910

10 Pieces – 1/16 to 1/4 H.S.S. 'Pic-a-drill' rigid styrene case hangs or stands on workbench. Each drill in a separate compartment. Good size coverage in a handy box. 1/16, 5/64, 3/32, 7/64, 1/8, 9/64, 5/32, 3/16, 7/32, 1/4.

C No. 020-913

13 Pieces – 1/16 to 1/4 H.S.S. 'Pic-a-drill' revolving case. 13 popular sizes in a new design rotating case. Dial each size as needed. 1/16, 5/64, 3/32, 7/64, 1/8, 9/64, 5/32, 11/64, 3/16, 13/64, 7/32, 15/64, 1/4.

D No. 020-914

14 Pieces – 1/16 to 1/2 with shanks reduced to 3/8. 'Pic-a-drill' strong folding polypropylene case holds and protects this fine set. 1/16, 5/64, 3/32, 7/64, 1/8, 9/64, 5/32, 3/16, 7/32, 1/4, 5/16, 3/8, and 7/16, 1/2, with 3/8 reduced shanks.

E No. 020-921

21 pieces – 1/16 to 3/8 by 64ths. H.S.S. A complete range of sizes for all requirements. 'Pic-a-drill' revolving case has clear rotating top for fast selection. Drill sizes clearly indexed.

F No. 022-114

A balanced stock of 14 'Pic-a-drill' sets. 6 No. 020-907, 3 No. 020-910, 2 No. 020-913, 2 No. 020-914 and 1 No. 020-921. Includes header sign and merchandising rack. Suitable for wall, pegboard, counter or gondola display. Size: 16" W x 14" H (Illustrated below.)



NOTES

Lined area for notes, consisting of multiple horizontal gray bars.

PERMA-THREAD®



PERMA-THREAD® HELICALLY COILED INSERTS

PERMA-PLUG SPARK PLUG REPAIR KIT

**PERMA-THREAD[®] HELICALLY COILED INSERTS
INSERTIONS HÉLICOÏDAUX PERMA-THREAD[®]**

Repair defective, stripped or damaged threads quickly and permanently. These inserts are made of diamond shaped stainless steel wire formed into a spiral screw thread coil.

They form a thread which is stronger than the original tapped material. The resilient quality of the insert allows it to adjust to eliminate stress concentration. The Perma-Thread[®] insert restores the hole to its initial size – a bolt or screw of the original size can be used for reassembly.

Full instructions for using the Perma-Thread[®] inserts are provided in each Repair Kit.

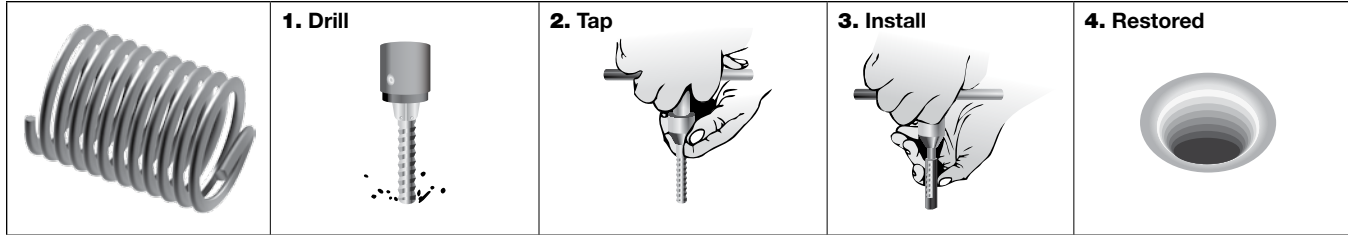

**THREAD REPAIR
MASTER ASSORTMENT**

No. 020-631

Includes contents of one Repair Kit of each 10-24, 1/4-20, 5/16-18, 3/8-16, 7/16-14, 1/2-13 and 14 mm with 3/8", 7/16", 1/2" and 3/4" reach.



THREAD REPAIR CENTRE

No. 1208-3

Stock the most popular Perma-Thread[®] Inserts on this colourful, metal display.

Five complete Thread Repair Kits: 1/4-20, 5/16-18, 3/8-16, 7/16-14, 1/2-13 - plus five packs of inserts. Also one 14 mm Spark Plug Kit (Tap and Tool) and three packs of plug inserts. Fourteen items plus rack.



**METRIC THREAD REPAIR
CENTRE**

No. 1221-3









Includes four Metric Thread Repair Kits: M5 x .8, M6 x 1.0, M8 x 1.25 and M10 x 1.5 - plus two Spark Plug Kits (Tap and Tool) for 12 mm and 14 mm plugs. Also four packs of plug inserts. Fourteen items plus rack.

PERMA-PLUG SPARK PLUG REPAIR KIT TROUSSE DE RÉPARATION DE BOUGIE 'PERMA-PLUG'

No. 2200-14

Includes one each of the items listed below:

Can be used with M14 x 1.25 taper seat or gasket type Spark Plugs in either aluminum or cast iron.
Easily installed without drilling – becomes a permanent repair.

| | | | | | | |
|---|---|--|--|--|---|--|
|  <p>Tap</p> |  <p>Piloted Tap</p> |  <p>Select Insert</p> |  <p>Short 2214-S</p>  <p>Normal 2214-N</p>  <p>Long 2214-L</p> |  <p>Install</p> |  <p>Expanding Tool</p> |  <p>Repaired</p> |
| <p>Lubricate tap. Start by hand then use socket to tap hole full depth. Clean chips from hole.</p> | <p>2258-14</p> | <p>Select insert length same as threads on spark plug. Coat outside threads with hi-temp RTV silicone. Knurled end of insert should be at top of hole.</p> | <p>Using spark plug, screw insert in until flush with spark plug hole.</p> | <p>2294-14</p> | <p>Place tool into insert and strike several times to expand knurl and lock insert. Install plug to recommended torque. Run engine after sealant has set.</p> | |

PERMA-PLUG DISPLAY CENTRE

No. 1400-1

Contents and Replacement Parts
ORDER BY STOCK NUMBER

| Stock No. | Description | Quantity |
|-----------|--------------------------------------|----------|
| 2200-14 | M14 x 1.25 Perma-Plug Kit | 3 |
| 2214-S | M14 x 1.25 x 3/8 Short Reach Insert | 4 |
| 2214-N | M14 x 1.25 x 1/2 Normal Reach Insert | 4 |
| 2214-L | M14 x 1.25 x 3/4 Long Reach Insert | 4 |



PERMA-THREAD® HELICALLY COILED INSERTS INSERTIONS HÉLICOÏDAUX PERMA-THREAD®

ORDER BY PART NUMBER

Repair Kits contain inserts, tap and installation tools. Inserts also available in standard packages.

| Repair Kits | Standard Packages | | | | | Repair Kits | | Taps | Tools |
|---|-------------------------|------------|----------|----------|----------------------|-------------|-------------|------------|----------|
| | Size | Insert Pkg | Drill | Qty | Kit | Inserts | Tap | Tool | |
| | Dia. x Length | Part No. | Size | Per Pack | Stock No. | Per Kit | Part No. | Part No. | |
| <p>Repair Kits for field or shop use. Complete Kits: Inserts-taps-tools.</p> | Unified National Coarse | | | | | | | | |
| | 4-40 | .168 | P208-014 | 1/8 | 12 | 1208-014 | 12 | 1428-014 | 1182-014 |
| | 5-40 | .188 | P208-015 | 9/64 | 12 | 1208-015 | 12 | 1428-015 | 1182-015 |
| | 6-32 | .207 | P208-016 | 5/32 | 12 | 1208-016 | 12 | 1428-016 | 1182-016 |
| | 8-32 | .246 | P208-018 | 11/64 | 12 | 1208-018 | 12 | 1428-018 | 1182-018 |
| | 10-24 | .285 | P208-101 | 13/64 | 12 | 1208-101 | 12 | 1428-101 | 1182-101 |
| | 12-24 | .324 | P208-102 | 15/64 | 12 | 1208-102 | 12 | 1428-102 | 1182-102 |
| | 1/4-20 | .375 | P208-104 | 17/64 | 12 | 1208-104 | 12 | 1428-104 | 1182-104 |
| | 5/16-18 | .469 | P208-105 | 21/64 | 12 | 1208-105 | 12 | 1428-105 | 1182-105 |
| | 3/8-16 | .562 | P208-106 | 25/64 | 12 | 1208-106 | 12 | 1428-106 | 1182-106 |
| | 7/16-14 | .656 | P208-107 | 29/64 | 6 | 1208-107 | 6 | 1428-107 | 1182-107 |
| | 1/2-13 | .750 | P208-108 | 17/32 | 6 | 1208-108 | 6 | 1428-108 | 1182-108 |
| | 9/16-12 | .844 | P208-109 | 19/32 | 6 | 1208-109 | 6 | 1428-109 | 1182-109 |
| | 5/8-11 | .938 | P208-110 | 21/32 | 6 | 1208-110 | 6 | 1428-110 | 1182-110 |
| | 3/4-10 | 1.125 | P208-112 | 25/32 | 4 | 1208-112 | 4 | 1428-112 | 1182-112 |
| | 7/8-9 | 1.312 | P108-114 | 29/32 | 1 | 3208-C14 | 6 | 1043-14CP3 | 1182-114 |
| | 1-8 | 1.500 | P108-116 | 1-1/32 | 1 | 3208-C16 | 6 | 1043-16CP3 | 1182-116 |
| | 1-1/8-7 | 1.688 | P108-118 | 1-5/32 | 1 | 3208-C18 | 5 | 1043-18CP3 | 1182-118 |
| | 1-1/4-7 | 1.875 | P108-120 | 1-9/32 | 1 | 3208-C20 | 5 | 1043-20CP3 | 1182-120 |
| | 1-3/8-6 | 2.062 | P108-122 | 1-13/32 | 1 | 3208-C22 | 4 | 1043-22CP3 | 1182-122 |
| | 1-1/2-6 | 2.250 | P108-124 | 1-17/32 | 1 | 3208-C24 | 4 | 1043-24CP3 | 1182-124 |
| | Unified National Fine | | | | | | | | |
| | 10-32 | .285 | P208-201 | 13/64 | 12 | 1208-201 | 12 | 1428-201 | 1172-201 |
| | 1/4-28 | .375 | P208-204 | 17/64 | 12 | 1208-204 | 12 | 1428-204 | 1172-204 |
| | 5/16-24 | .469 | P208-205 | 21/64 | 12 | 1208-205 | 12 | 1428-205 | 1172-205 |
| | 3/8-24 | .562 | P208-206 | 25/64 | 12 | 1208-206 | 12 | 1428-206 | 1172-206 |
| | 7/16-20 | .656 | P208-207 | 29/64 | 6 | 1208-207 | 6 | 1428-207 | 1172-207 |
| 1/2-20 | .750 | P208-208 | 33/64 | 6 | 1208-208 | 6 | 1428-208 | 1172-208 | |
| 9/16-18 | .844 | P208-209 | 37/64 | 6 | 1208-209 | 6 | 1428-209 | 1172-209 | |
| 5/8-18 | .938 | P208-210 | 41/64 | 6 | 1208-210 | 6 | 1428-210 | 1172-210 | |
| 3/4-16 | 1.125 | P208-212 | 49/64 | 4 | 1208-212 | 4 | 1428-212 | 1172-212 | |
| 7/8-14 | 1.312 | P108-214 | 57/64 | 1 | 3208-F14 | 6 | 1043-14FP3 | 1039-14F | |
| 1-14 | 1.500 | P108-2164 | 1-1/64 | 1 | 3208-F164 | 6 | 1043-164FP3 | 1039-164F | |
| 1-1/8-12 | 1.688 | P108-218 | 1-5/32 | 1 | 3208-F18 | 5 | 1043-18FP3 | 1039-18F | |
| 1-1/4-12 | 1.875 | P108-220 | 1-9/32 | 1 | 3208-F20 | 5 | 1043-20FP3 | 1039-20F | |
| 1-3/8-12 | 2.062 | P108-222 | 1-13/32 | 1 | 3208-F22 | 4 | 1043-22FP3 | 1039-22F | |
| 1-1/2-12 | 2.250 | P108-224 | 1-17/32 | 1 | 3208-F24 | 4 | 1043-24FP3 | 1039-24F | |
| Standard Metric Series | | | | | Coarse Thread Series | | | | |
| M5 x 0.8 | 7.5 mm | P206-305 | 13/64 | 12 | 1221-305 | 12 | 1448-305 | 1287-305 | |
| M6 x 1.0 | 9.0 mm | P206-306 | 1/4 | 12 | 1221-306 | 12 | 1448-306 | 1287-306 | |
| M7 x 1.0 | 10.5 mm | P206-307 | 9/32 | 12 | 1221-307 | 12 | 1448-307 | 1289-307 | |
| M8 x 1.25 | 12.0 mm | P206-308 | 21/64 | 12 | 1221-308 | 12 | 1448-308 | 1289-308 | |
| M9 x 1.25 | 13.5 mm | P206-309 | m9.4 | 12 | 1221-309 | 12 | 1448-309 | 1289-309 | |
| M10 x 1.50 | 15.0 mm | P206-310 | 13/32 | 12 | 1221-310 | 12 | 1448-310 | 1289-310 | |
| M11 x 1.50 | 16.5 mm | P106-311 | 29/64 | 6 | 1221-311 | 6 | 1448-311 | 1289-311 | |
| M12 x 1.75 | 18.0 mm | P106-312 | 31/64 | 6 | 3221-M12C | 6 | 5043-120CP4 | 1289-312 | |
| M14 x 2.0 | 21.0 mm | P106-314 | 37/64 | 6 | 3221-M14C | 6 | 5043-140CP4 | 1289-314 | |
| M16 x 2.0 | 24.0 mm | P106-316 | 21/32 | 6 | 3221-M16C | 6 | 5043-160CP4 | 1289-316 | |
| M18 x 2.5 | 27.0 mm | P106-318 | 47/64 | 6 | 3221-M18C | 6 | 5043-180CP4 | 1289-318 | |
| M20 x 2.5 | 30.0 mm | P106-320 | 13/16 | 6 | 3221-M20C | 6 | 5043-200CP4 | 1289-320 | |
| | | | | | Fine Thread Series | | | | |
| M10 x 1.25 | 15.0 mm | P106-610 | 13/32 | 6 | 3221-M10F | 6 | 5043-100FP4 | 1287-610 | |
| M11 x 1.25 | 16.5 mm | P106-61125 | 29/64 | 6 | 1221-M1125 | 6 | 1448-61125 | 1287-61125 | |
| M12 x 1.25 | 18.0 mm | P106-612 | 31/64 | 6 | 3221-M12F | 6 | 5043-120FP4 | 1287-612 | |
| M12 x 1.5 | 18.0 mm | P106-61215 | 31/64 | 6 | 3221-M1215 | 6 | 5043-1215P4 | 1287-61215 | |
| M14 x 1.5 | 21.0 mm | P106-614 | 9/16 | 6 | 3221-M14F | 6 | 5043-140FP4 | 1287-614 | |
| M16 x 1.5 | 24.0 mm | P106-616 | 21/32 | 6 | 3221-M16F | 6 | 5043-160FP4 | 1287-616 | |
| Spark Plug Series - Do not use these inserts to repair taper seat spark plug ports | | | | | | | | | |
| M10 x 1.0 | .500 | P410-500 | - | 6 | 1210-410* | - | 1458-100 | 1094-100 | |
| M12 x 1.25 | .500 | P412-500 | - | 6 | 1212-412* | - | 1458-123 | 1094-123 | |
| M12 x 1.25 | .750 | P412-750 | - | 6 | - | - | - | - | |
| M14 x 1.25 | .375 | P414-375 | - | 6 | 1214-414* | - | 1458-143 | 1094-143 | |
| M14 x 1.25 | .438 | P414-438 | - | 6 | - | - | - | - | |
| M14 x 1.25 | .500 | P414-500 | - | 6 | - | - | - | - | |
| M14 x 1.25 | .750 | P414-750 | - | 6 | - | - | - | - | |
| M18 x 1.50 | .500 | P418-500 | - | 6 | 1218-500 | 6 | 1458-185 | 1094-185 | |
| 'Perma-Plug' Spark Plug Series - Can be used with taper seat or gasket type spark plugs | | | | | | | | | |
| M14 x 1.25 | .375 | 2214S | - | 1 | - | - | - | - | |
| M14 x 1.25 | .500 | 2214N | - | 1 | 2200-14 | - | 2258-14 | 2294-14 | |
| M14 x 1.25 | .750 | 2214L | - | 1 | - | - | - | - | |

* NOTE: 10mm, 12mm and 14mm spark plug kits contain combination piloted Reamer/Tap tool and NO inserts. Same tools are applicable regardless of insert length. Purchase packs of inserts separately. Perma-Thread® Repair Kits include: Inserts, Tap, Installation Tool, Instructions unless otherwise specified.

AN INTRODUCTION TO...

STAINLESS STEEL

ACIER INOXYDABLE

...UNE INTRODUCTION.

www.hpaulin.com

For a full listing of Stainless Steel, please refer to our current catalogue or visit our website to download a PDF version.

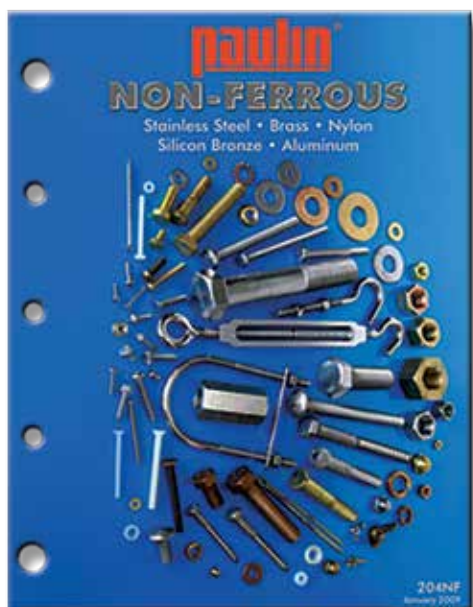

HEX BOLTS

CARRIAGE BOLTS

LAG BOLTS

SOCKET HEAD CAP SCREWS

FINISHED HEX NUTS

NYLON INSERT STOP NUTS

HEX MACHINE SCREW NUTS

WASHERS

COTTER PINS

THREADED RODS

MACHINE SCREWS



18.8 STAINLESS STEEL HEX BOLTS BOULONS HEX EN ACIER INOXYDABLE 18,8



5000 Series

Corrosion resistant Type 300 Series (18% chromium - 8% nickel). Used in marine applications, food processing equipment and wherever resistance to most acids and chemicals is required. Non-magnetic. UNC thread.

Order by stock number.

| Stock No. | Size | Std. Pkg. | Stock No. | Size | Std. Pkg. | Stock No. | Size | Std. Pkg. | Stock No. | Size | Std. Pkg. |
|-----------|----------------|-----------|-----------|-----------------|-----------|-----------|----------------|-----------|-----------|----------------|-----------|
| 5000-307 | 1/4-20 x 3/4 | 100 | 5000-442 | 5/16-18 x 3/4 | 100 | 5000-487 | 3/8-16 x 3/4 | 100 | 5000-577 | 1/2-13 x 3/4 | 25 |
| 5000-309 | 1/4-20 x 1 | 100 | 5000-444 | 5/16-18 x 1 | 100 | 5000-489 | 3/8-16 x 1 | 100 | 5000-579 | 1/2-13 x 1 | 25 |
| 5000-313 | 1/4-20 x 1-1/2 | 100 | 5000-448 | 5/16-18 x 1-1/2 | 100 | 5000-493 | 3/8-16 x 1-1/2 | 100 | 5000-583 | 1/2-13 x 1-1/2 | 25 |
| 5000-316 | 1/4-20 x 2 | 100 | 5000-451 | 5/16-18 x 2 | 100 | 5000-496 | 3/8-16 x 2 | 100 | 5000-586 | 1/2-13 x 2 | 20 |
| 5000-318 | 1/4-20 x 2-1/2 | 50 | 5000-453 | 5/16-18 x 2-1/2 | 50 | 5000-498 | 3/8-16 x 2-1/2 | 50 | 5000-588 | 1/2-13 x 2-1/2 | 20 |
| 5000-320 | 1/4-20 x 3 | 25 | 5000-455 | 5/16-18 x 3 | 25 | 5000-500 | 3/8-16 x 3 | 25 | 5000-590 | 1/2-13 x 3 | 10 |

18.8 STAINLESS STEEL CARRIAGE BOLTS BOULONS DE CARROSSE ACIER INOXYDABLE 18,8

5002 Series



Order by stock number.

| Stock No. | Size | Std. Pkg. | Stock No. | Size | Std. Pkg. | Stock No. | Size | Std. Pkg. |
|-----------|----------------|-----------|-----------|-----------------|-----------|-----------|----------------|-----------|
| 5002-309 | 1/4-20 x 1 | 100 | 5002-444 | 5/16-18 x 1 | 50 | 5002-489 | 3/8-16 x 1 | 50 |
| 5002-313 | 1/4-20 x 1-1/2 | 100 | 5002-448 | 5/16-18 x 1-1/2 | 50 | 5002-493 | 3/8-16 x 1-1/2 | 50 |
| 5002-316 | 1/4-20 x 2 | 100 | 5002-451 | 5/16-18 x 2 | 50 | 5002-496 | 3/8-16 x 2 | 25 |
| 5002-318 | 1/4-20 x 2-1/2 | 50 | 5002-453 | 5/16-18 x 2-1/2 | 25 | 5002-498 | 3/8-16 x 2-1/2 | 25 |
| 5002-320 | 1/4-20 x 3 | 50 | 5002-455 | 5/16-18 x 3 | 25 | 5002-500 | 3/8-16 x 3 | 25 |
| 5002-324 | 1/4-20 x 4 | 25 | 5002-459 | 5/16-18 x 4 | 25 | 5002-504 | 3/8-16 x 4 | 10 |

18.8 STAINLESS STEEL LAG BOLTS TIRE-FOND ACIER INOXYDABLE 18,8

5003 Series



Order by stock number.

| Stock No. | Size | Std. Pkg. | Stock No. | Size | Std. Pkg. | Stock No. | Size | Std. Pkg. | Stock No. | Size | Std. Pkg. |
|-----------|----------------|-----------|-----------|-----------------|-----------|-----------|----------------|-----------|-----------|----------------|-----------|
| 5003-309 | 1/4-20 x 1 | 50 | — | 5/16-18 x 1 | — | 5003-493 | 3/8-16 x 1-1/2 | 50 | 5003-586 | 1/2-13 x 2 | 50 |
| 5003-313 | 1/4-20 x 1-1/2 | 50 | 5003-448 | 5/16-18 x 1-1/2 | 50 | 5003-496 | 3/8-16 x 2 | 50 | 5003-588 | 1/2-13 x 2-1/2 | 25 |
| 5003-316 | 1/4-20 x 2 | 50 | 5003-451 | 5/16-18 x 2 | 50 | 5003-498 | 3/8-16 x 2-1/2 | 25 | 5003-590 | 1/2-13 x 3 | 25 |
| 5003-318 | 1/4-20 x 2-1/2 | 25 | 5003-453 | 5/16-18 x 2-1/2 | 25 | 5003-500 | 3/8-16 x 3 | 25 | 5003-594 | 1/2-13 x 4 | 20 |
| 5003-320 | 1/4-20 x 3 | 25 | 5003-455 | 5/16-18 x 3 | 25 | 5003-504 | 3/8-16 x 4 | 20 | | | |
| 5003-324 | 1/4-20 x 4 | 20 | 5003-459 | 5/16-18 x 4 | 20 | | | | | | |

18.8 STAINLESS STEEL SOCKET HEAD CAP SCREWS BOULONS DE PRESSION ACIER INOXYDABLE 18,8

5006 UNC



Order by stock number.

| Stock No. | Size | Std. Pkg. | Stock No. | Size | Std. Pkg. | Stock No. | Size | Std. Pkg. | Stock No. | Size | Std. Pkg. |
|-----------|----------------|-----------|-----------|-----------------|-----------|-----------|----------------|-----------|-----------|----------------|-----------|
| 5006-309 | 1/4-20 x 1 | 100 | 5006-444 | 5/16-18 x 1 | 100 | 5006-489 | 3/8-16 x 1 | 100 | 5006-579 | 1/2-13 x 1 | 50 |
| 5006-313 | 1/4-20 x 1-1/2 | 100 | 5006-448 | 5/16-18 x 1-1/2 | 100 | 5006-493 | 3/8-16 x 1-1/2 | 100 | 5006-583 | 1/2-13 x 1-1/2 | 50 |
| 5006-316 | 1/4-20 x 2 | 100 | 5006-451 | 5/16-18 x 2 | 100 | 5006-496 | 3/8-16 x 2 | 50 | 5006-586 | 1/2-13 x 2 | 50 |
| 5006-318 | 1/4-20 x 2-1/2 | 100 | 5006-453 | 5/16-18 x 2-1/2 | 100 | 5006-498 | 3/8-16 x 2-1/2 | 50 | 5006-588 | 1/2-13 x 2-1/2 | 25 |
| 5006-320 | 1/4-20 x 3 | 50 | 5006-455 | 5/16-18 x 3 | 50 | 5006-500 | 3/8-16 x 3 | 50 | 5006-590 | 1/2-13 x 3 | 25 |

18.8 STAINLESS STEEL FINISHED HEX NUTS ÉCROUS HEX ACIER INOXYDABLE 18,8

5026
Series

Order by stock number.

| Stock No. | Bolt Size | Std. Pkg. |
|-----------|-----------|-----------|
| 5026-014 | 1/4-20 | 100 |
| 5026-016 | 5/16-18 | 100 |
| 5026-018 | 3/8-16 | 100 |
| 5026-022 | 1/2-13 | 50 |



18.8 STAINLESS STEEL NYLON INSERT STOP NUTS ÉCROUS À BLOCAGE NYLON INOXYDABLE 18,8

5034
Series

Order by stock number.

| Stock No. | Bolt Size | Std. Pkg. |
|-----------|-----------|-----------|
| 5034-006 | 6-32 | 100 |
| 5034-008 | 8-32 | 100 |
| 5034-010 | 10-24 | 100 |
| 5034-011 | 10-32 | 100 |
| 5034-014 | 1/4-20 | 100 |
| 5034-016 | 5/16-18 | 100 |
| 5034-018 | 3/8-16 | 100 |
| 5034-022 | 1/2-13 | 50 |



18.8 STAINLESS STEEL HEX MACHINE SCREW NUTS ÉCROUS POUR VIS DE MÉCANIQUE ACIER INOXYDABLE 18,8

5035
Series

Order by stock number.

| Stock No. | Bolt Size | Std. Pkg. |
|-----------|-----------|-----------|
| 5035-006 | 6-32 | 100 |
| 5035-008 | 8-32 | 100 |
| 5035-010 | 10-24 | 100 |
| 5035-014 | 1/4-20 | 100 |



For a complete listing of non-ferrous and stainless fasteners see separate Papco[®] Corrosion Resistant Catalogue.

18.8 STAINLESS STEEL WASHER RONDELLES ACIER INOXYDABLE 18,8

5055
Series

18.8 Flat Washers

Order by stock number.

| Stock No. | Bolt Size | I.D. | O.D. | Thickness | Std. Pkg. |
|-----------|-----------|------|-------|-----------|-----------|
| 5055-206 | No. 6 | .156 | 3/8 | .031 | 100 |
| 5055-208 | No. 8 | .174 | 3/8 | .031 | 100 |
| 5055-210 | No. 10 | .203 | 7/16 | .031 | 100 |
| 5055-214 | 1/4 | .281 | 5/8 | .050 | 100 |
| 5055-216 | 5/16 | .345 | 3/4 | .050 | 100 |
| 5055-218 | 3/8 | .406 | 7/8 | .050 | 100 |
| 5055-222 | 1/2 | .531 | 1-1/4 | .062 | 50 |



5056
Series

18.8 Finishing Washers

Order by stock number.

| Stock No. | Screw Size | Std. Pkg. |
|-----------|------------|-----------|
| 5056-971 | No. 6 | 100 |
| 5056-973 | No. 8 | 100 |
| 5056-975 | No. 10 | 100 |
| 5056-979 | 1/4 | 100 |



5057
Series

18.8 Fender Washers

Order by stock number.

| Stock No. | Bolt Size | O.D. | Std. Pkg. |
|-----------|-----------|-------|-----------|
| 5057-394 | No. 10 | 1 | 100 |
| 5057-395 | 1/4 | 1-1/4 | 100 |
| 5057-396 | 5/16 | 1-1/2 | 100 |
| 5057-398 | 3/8 | 1-1/2 | 100 |
| 5057-400 | 1/2 | 2 | 50 |



5058
Series

18.8 Regular Lock Washers

Order by stock number.

| Stock No. | Bolt Size | Std. Pkg. |
|-----------|-----------|-----------|
| 5058-014 | 1/4 | 100 |
| 5058-016 | 5/16 | 100 |
| 5058-018 | 3/8 | 100 |
| 5058-022 | 1/2 | 100 |



**18.8 STAINLESS COTTER PINS
GOUPILLES ACIER INOXYDABLE 18,8**

5080
Series



Order by stock number.

| Stock No. | Size | Std. Pkg. |
|-----------|--------------|-----------|
| 5080-091 | 3/32 x 1 | 100 |
| 5080-095 | 3/32 x 1-1/2 | 100 |
| 5080-141 | 1/8 x 1 | 100 |
| 5080-145 | 1/8 x 1-1/2 | 100 |
| 5080-148 | 1/8 x 2 | 100 |
| 5080-171 | 5/32 x 1-1/2 | 100 |
| 5080-174 | 5/32 x 2 | 100 |

**18.8 STAINLESS STEEL THREADED ROD
TIGES FILETÉES ACIER INOXYDABLE 18,8**

5091
Series



Std. Pkg. as required.

Order by stock number.

| Stock No. | Size | Stock No. | Size |
|-----------|---------------|-----------|---------------|
| 5091-310 | 10-24 x 36" | 5091-354 | 1/4-20 x 72" |
| 5091-314 | 1/4-20 x 36" | 5091-356 | 5/16-18 x 72" |
| 5091-316 | 5/16-18 x 36" | 5091-358 | 3/8-16 x 72" |
| 5091-318 | 3/8-16 x 36" | 5091-362 | 1/2-13 x 72" |
| 5091-322 | 1/2-13 x 36" | 5091-364 | 5/8-11 x 72" |
| 5091-324 | 5/8-11 x 36" | 5091-366 | 3/4-10 x 72" |
| 5091-326 | 3/4-10 X36" | | |

Note: Fine Thread 36" long Threaded Rods are available – price on application.

**18.8 STAINLESS MACHINE SCREWS
VIS DE MÉCANIQUE INOXYDABLE 18,8**

5113
OVAL



5114
PAN

PHILLIPS

Order by stock number.

| Stock No. | Size | Std. Pkg. |
|-----------|-------------------------|-----------|
| 5113-087 | 5114-087 6-32 x 1/2 | 100 |
| 5113-091 | 5114-091 6-32 x 1 | 100 |
| 5113-141 | 5114-141 8-32 x 1 | 100 |
| 5113-193 | 5114-193 10-24 x 1 | 100 |
| 5113-197 | 5114-197 10-24 x 1-1/2 | 100 |
| 5113-200 | 5114-200 10-24 x 2 | 100 |
| 5113-313 | 5114-313 1/4-20 x 1-1/2 | 100 |
| 5113-316 | 5114-316 1/4-20 x 2 | 100 |

**18.8 STAINLESS TAPPING SCREWS
VIS TARAUEUSES INOXYDABLE 18,8**

5162
Series



SQUARE DRIVE

Order by stock number.

| Stock No. | Size | Std. Pkg. |
|-----------|------------|-----------|
| 5162-089 | 6 x 3/4 | 100 |
| 5162-139 | 8 x 3/4 | 100 |
| 5162-141 | 8 x 1 | 100 |
| 5162-193 | 10 x 1 | 100 |
| 5162-195 | 10 x 1-1/4 | 100 |
| 5162-197 | 10 x 1-1/2 | 100 |
| 5162-254 | 12 x 1-1/2 | 100 |

**18.8 STAINLESS TAPPING SCREWS - TYPE A
VIS TARAUEUSES INOXYDABLE 18,8**

5163
PAN



5165
OVAL

Order by stock number.

| Stock No. | Size | Std. Pkg. |
|-----------|-------------------|-----------|
| 5163-043 | 5165-043 4 x 1/2 | 100 |
| 5163-089 | 5165-089 6 x 3/4 | 100 |
| 5163-091 | 5165-091 6 x 1 | 100 |
| 5163-139 | 5165-139 8 x 3/4 | 100 |
| 5163-141 | 5165-141 8 x 1 | 100 |
| 5163-191 | 5165-191 10 x 3/4 | 100 |
| 5163-193 | 5165-193 10 x 1 | 100 |

18.8 STAINLESS STEEL 6-LOBE TRIM SCREWS VIS FINITION À SIX PANS ACIER INOXYDABLE 18,8

231
Series



CHROME PLATED

| OVAL 6-LOBE HEAD 18.8 STAINLESS | | |
|---------------------------------|--------------|------|
| Part No. | Dia x Length | Qty. |
| 231-205 | 4.2 x 20 mm | 25 |
| 231-209 | 4.2 x 30 mm | 25 |
| 231-213 | 4.2 x 40 mm | 25 |
| 231-219 | 4.2 x 55 mm | 25 |

BLACK OXIDE

| OVAL 6-LOBE HEAD 18.8 STAINLESS | | |
|---------------------------------|--------------|------|
| Part No. | Dia x Length | Qty. |
| 231-206 | 4.2 x 20 mm | 25 |
| 231-210 | 4.2 x 30 mm | 25 |



CHROME PLATED

| PAN 6-LOBE HEAD 18.8 STAINLESS | | |
|--------------------------------|--------------|------|
| Part No. | Dia x Length | Qty. |
| 231-251 | 4.2 x 20 mm | 25 |
| 231-257 | 4.2 x 35 mm | 25 |

BLACK OXIDE

| PAN 6-LOBE HEAD 18.8 STAINLESS | | |
|--------------------------------|--------------|------|
| Part No. | Dia x Length | Qty. |
| 231-252 | 4.2 x 20 mm | 25 |
| 231-264 | 4.2 x 50 mm | 25 |

STAINLESS GARAGE ASSORTMENT ASSORTIMENT DE GARAGE INOXYDABLE

No. 020-212

Contains 110 pieces - 8 sizes of Pan and Oval Socket 18.8 Stainless Steel Tapping Screws and 2 sizes of 18.8 Stainless Finishing Washers packed in a transparent plastic box.



020-212

MARINE FASTENERS MASTER ASSORTMENT ASSORTIMENT GÉNÉRAL D'ATTACHES MARIN

This Master Assortment is ideal for the boat owner for attaching railings, brackets, swivels, posts and other marine equipment and accessories. Each product is fully illustrated on the price coded lid label. Excellent for self-serve sales. Metal box with high-strength, moulded plastic compartments and safety locking lid.

No. 020-673

Contains 20 sizes of Stainless Steel Tapping Screws, Wood Screws, Machine Screws, Nuts and Finishing Washers.



020-673

PLASTIC ASSORTMENT KITS ASSORTIMENTS DE PLASTIQUE

No. 021-600

S.S. MARINE KIT #1 BOLTS, NUTS & WASHERS

Contains 514 pieces, 3 types of bolts, 4 types of nuts and 3 types of washers.



021-600

No. 021-601

S.S. MARINE KIT #2 SCREWS, WASHERS & BITS

Contains 648 pieces, 3 types of screws, 2 types of driver bits and washers.



021-601

For more information on Plastic Assortment S.S. Marine Kits No. 021-600 & No. 021-601 please refer to pages 9 & 12.

AN INTRODUCTION TO...

BRAKE LINES TUBULURES DE FREIN

...UNE INTRODUCTION.

www.hpaulin.com

For a full listing of Papco Flex® Lines, Adaptors, Fittings and Tools, please refer to our current catalogue or visit our website to download a PDF version.

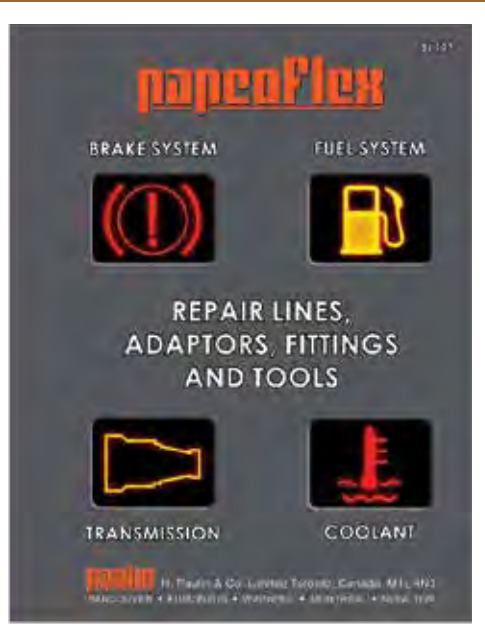

The image shows the cover of a PapcoFlex product catalog. At the top, the 'papcoflex' logo is displayed in a stylized font. Below the logo, there are four categories represented by icons: 'BRAKE SYSTEM' with a red exclamation mark in a circle, 'FUEL SYSTEM' with a yellow fuel pump icon, 'TRANSMISSION' with a yellow gear icon, and 'COOLANT' with a red radiator icon. In the center, the text reads 'REPAIR LINES, ADAPTORS, FITTINGS AND TOOLS'. At the bottom, there is contact information for 'hpaulin H. Paulin & Co. Limited Toronto, Canada, M1L 4P2' and phone numbers for 'MANITOBA • 811-811-8111 • 416-291-1111 • 416-291-1111 • 416-291-1111'.

HYDRAULIC BRAKE LINES

BRAKE LINE MERCHANTISERS

BRAKE LINE TUBING

HYDRAULIC BRAKE FITTINGS

BRAKE LINE FITTINGS

BRAKE BLEEDER SCREWS

HYDRAULIC GREASE FITTINGS





**STEEL HYDRAULIC BRAKE LINES
TUBULURE DE FREIN HYDRAULIQUE**

Papcoflex Steel Hydraulic Brake Lines are ideal replacement parts for hydraulic brake, transmission, gas, oil and vacuum lines used on all cars, trucks, buses and tractors.

1. All Papco Brake Lines feature a copper brazed, double-walled steel construction coupled with a zinc outer coating that provides resistance to rust, leakage, pressure and vibration.
2. Papco lines comply to GM123M-ASV and S.A.E. J527B, have wall thickness of 0.028" (0.70mm) and withstands pressures to 17,000 psi.
3. All Papco lines can easily be shaped by hand to duplicate the original without crimping or collapsing.

Papcoflex **POLY-V Coated Brake Lines** feature a polyvinyl flouride coating to resist corrosion, nicks and dents while providing up to 30 times the protection of standard steel brake lines.

Papcoflex **Armoured Steel Brake Lines** feature the highest degree of protection against common road hazards. Each steel line is wound the entire length with a 0.046" diameter high carbon, galvanized wire and comes complete with flared fittings.

CUPRO-NICKEL Tubing Brake Lines are guaranteed for the life of the vehicle and afford the ultimate resistance to corrosion. Easiest to bend and flare. Guarantee is limited to the replacement of the product under normal wear and tear circumstances and the proper preparation (flaring) of the lines and installation.



S - STEEL P - POLY-V AS - ARMoured STEEL CN - COPPER NICKEL

ORDER BY STOCK NUMBER

| Overall Length | 3/16 O.D. | | | | 1/4 O.D. | | | | 5/16 O.D. | | | | 3/8 O.D. | | | |
|----------------|-----------|--------|--------|--------|----------|--------|--------|--------|-----------|--------|--------|--------|----------|--------|--------|--------|
| | S | P | AS | CN | S | P | AS | CN | S | P | AS | CN | S | P | AS | CN |
| 6" | S-306 | - | AS-306 | - | - | - | - | - | - | - | - | - | - | - | - | - |
| 8" | S-308 | PS-308 | AS-308 | CN-308 | S-408 | PS-408 | AS-408 | CN-408 | S-508 | PS-508 | AS-508 | CN-508 | S-608 | PS-608 | - | CN-608 |
| 10" | S-310 | - | AS-310 | - | S-410 | - | - | - | S-510 | PS-510 | AS-510 | - | S-610 | - | AS-610 | - |
| 12" | S-312 | PS-312 | AS-312 | CN-312 | S-412 | PS-412 | AS-412 | CN-412 | S-512 | PS-512 | AS-512 | CN-512 | S-612 | PS-612 | AS-612 | CN-612 |
| 20" | S-320 | PS-320 | AS-320 | CN-320 | S-420 | PS-420 | AS-420 | CN-420 | S-520 | PS-520 | AS-520 | CN-520 | S-620 | PS-620 | AS-620 | CN-620 |
| 30" | S-330 | PS-330 | AS-330 | CN-330 | S-430 | PS-430 | AS-430 | CN-430 | S-530 | PS-530 | AS-530 | CN-530 | S-630 | PS-630 | AS-630 | CN-630 |
| 40" | S-340 | PS-340 | AS-340 | CN-340 | S-440 | PS-440 | AS-440 | CN-440 | S-540 | PS-540 | AS-540 | CN-540 | S-640 | PS-640 | AS-640 | CN-640 |
| 51" | S-351 | PS-351 | AS-351 | CN-351 | S-451 | PS-451 | AS-451 | CN-451 | S-551 | PS-551 | AS-551 | CN-551 | S-651 | PS-651 | AS-651 | CN-651 |
| 60" | S-360 | PS-360 | AS-360 | CN-360 | S-460 | PS-460 | AS-460 | CN-460 | S-560 | PS-560 | AS-560 | CN-560 | S-660 | PS-660 | AS-660 | CN-660 |
| 72" | S-372 | PS-372 | AS-372 | CN-372 | S-472 | PS-472 | AS-472 | CN-472 | S-572 | PS-572 | AS-572 | CN-572 | S-672 | PS-672 | AS-672 | CN-672 |

METRIC BRAKE LINES

All the proven features of the Papcoflex Steel Hydraulic Brake Line. Available in three types, all 3/16" diameter and in popular lengths as listed.

Type 'A': Metric Thread with standard flare. For Nissan, Honda, Mazda and Toyota.

Type 'B': U.S. Thread with bubble flare. For Austin, Cortina, Cricket, Fiat, Jaguar, M.G. and Triumph.

Type 'C': Metric Thread with bubble flare. For BMW, Citroen, Mercedes-Benz, Peugeot, Porsche, VW.

S - STEEL P - POLY-V CN - COPPER NICKEL

ORDER BY STOCK NUMBER

| Overall Length | TYPE 'A' | | | TYPE 'B' | | | TYPE 'C' | | | TYPE 'T' | | 6.0 mm O.D. GM / IMPORTS | |
|----------------|----------|---------|----------|----------|---------|----------|----------|---------|----------|----------|----------|--------------------------|----------|
| | S | P | CN | S | P | CN | S | P | CN | S | CN | S | CN |
| 8" | MA308 | PMA-308 | CNMA-308 | MB308 | PMB-308 | CNMB-308 | MC308 | PMC-308 | CNMC-308 | MT308 | CNMT-308 | MM308 | CNMM-308 |
| 12" | MA312 | PMA-312 | CNMA-312 | MB312 | PMB-312 | CNMB-312 | MC312 | PMC-312 | CNMC-312 | MT312 | CNMT-312 | MM312 | CNMM-312 |
| 20" | MA320 | PMA-320 | CNMA-320 | MB320 | PMB-320 | CNMB-320 | MC320 | PMC-320 | CNMC-320 | MT320 | CNMT-320 | MM320 | CNMM-320 |
| 30" | MA330 | PMA-330 | CNMA-330 | MB330 | PMB-330 | CNMB-330 | MC330 | PMC-330 | CNMC-330 | MT330 | CNMT-330 | MM330 | CNMM-330 |
| 40" | MA340 | PMA-340 | CNMA-340 | MB340 | PMB-340 | CNMB-340 | MC340 | PMC-340 | CNMC-340 | MT340 | CNMT-340 | MM340 | CNMM-340 |
| 51" | MA351 | PMA-351 | CNMA-351 | MB351 | PMB-351 | CNMB-351 | MC351 | PMC-351 | CNMC-351 | MT351 | CNMT-351 | MM351 | CNMM-351 |
| 60" | MA360 | PMA-360 | CNMA-360 | MB360 | PMB-360 | CNMB-360 | MC360 | PMC-360 | CNMC-360 | MT360 | CNMT-360 | MM360 | CNMM-360 |

NOTE: Type 'T' Lines – Toyota / GM Long Nut.



STEEL BRAKE LINE MERCHANDISERS PRÉSENTOIRS TUBULURE DE FREIN

Papcoflex steel brake line floor merchandisers are available in 5 variations and may be linked together to form a master warehouse stock to cover almost every brake line requirement. Compact wire rack measures 9-1/2" w x 20-1/2" d x 28" h and includes colour-coded, permanent PVC storage tubes for dispensing lines. Each Papcoflex Brake Line is labelled showing part number, O.D. and length.



No. 022-284

Empty Wire Rack (with tubes and colour-coded labels to create your own mix of lines)

STEEL BRAKE LINE MERCHANDISER

No. 022-285

Contains 3 each of 28 sizes of Papcoflex Brake Lines for a total of 84 lines. Rack and tubes included.

POLY-V COATED BRAKE LINES MERCHANDISER

No. 022-585

Contains 3 each of 28 sizes of **POLY-V** Coated Steel Brake Lines for a total of 84 lines. Rack and tubes included.

S - STEEL **P - POLY-V**

ORDER BY STOCK NUMBER

| Overall Length | 3/16 O.D. | | 1/4 O.D. | | 5/16 O.D. | | 3/8 O.D. | |
|----------------|-----------|--------|----------|--------|-----------|--------|----------|--------|
| | S | P | S | P | S | P | S | P |
| 8" | S-308 | PS-308 | S-408 | PS-408 | S-508 | PS-508 | S-610 | PS-608 |
| 12" | S-312 | PS-312 | S-412 | PS-412 | S-512 | PS-512 | S-612 | PS-612 |
| 20" | S-320 | PS-320 | S-420 | PS-420 | S-520 | PS-520 | S-620 | PS-620 |
| 30" | S-330 | PS-330 | S-430 | PS-430 | S-530 | PS-530 | S-630 | PS-630 |
| 40" | S-340 | PS-340 | S-440 | PS-440 | S-540 | PS-540 | S-640 | PS-640 |
| 51" | S-351 | PS-351 | S-451 | PS-451 | S-551 | PS-551 | S-651 | PS-651 |
| 60" | S-360 | PS-360 | S-460 | PS-460 | S-560 | PS-560 | S-660 | PS-660 |

ARMOURED BRAKE LINE MERCHANDISER

No. 022-286

Contains 3 each of 28 sizes of Papcoflex Armoured Brake Lines for a total of 84 lines. Rack and tubes included.

AS - ARMOURD STEEL

ORDER BY STOCK NUMBER

| Overall Length | 3/16 O.D. | 1/4 O.D. | 5/16 O.D. | 3/8 O.D. |
|----------------|-----------|----------|-----------|----------|
| | AS | AS | AS | AS |
| 8" | AS-308 | AS-408 | AS-508 | AS-610 |
| 12" | AS-312 | AS-412 | AS-512 | AS-612 |
| 20" | AS-320 | AS-420 | AS-520 | AS-620 |
| 30" | AS-330 | AS-430 | AS-530 | AS-630 |
| 40" | AS-340 | AS-440 | AS-540 | AS-640 |
| 51" | AS-351 | AS-451 | AS-551 | AS-651 |
| 60" | AS-360 | AS-460 | AS-560 | AS-660 |

METRIC BRAKE LINE MERCHANDISER

No. 022-287

Contains 3 each of 21 sizes of Papcoflex Metric Brake Lines for a total of 63 lines. Rack and tubes included.

POLY-V COATED METRIC BRAKE LINES MERCHANDISER

022-586

Contains 3 each of 21 sizes of **POLY-V** Coated Metric Brake Lines for a total of 63 lines. Rack and tubes included.

S - STEEL **P - POLY-V**

ORDER BY STOCK NUMBER

| Overall Length | TYPE 'A' JAPANESE | | TYPE 'B' BRITISH | | TYPE 'C' EUROPEAN | |
|----------------|-------------------|---------|------------------|---------|-------------------|---------|
| | S | P | S | P | S | P |
| 8" | MA308 | PMA-308 | MB308 | PMB-308 | MC308 | PMC-308 |
| 12" | MA312 | PMA-312 | MB312 | PMB-312 | MC312 | PMC-312 |
| 20" | MA320 | PMA-320 | MB320 | PMB-320 | MC320 | PMC-320 |
| 30" | MA330 | PMA-330 | MB330 | PMB-330 | MC330 | PMC-330 |
| 40" | MA340 | PMA-340 | MB340 | PMB-340 | MC340 | PMC-340 |
| 51" | MA351 | PMA-351 | MB351 | PMB-351 | MC351 | PMC-350 |
| 60" | MA360 | PMA-360 | MB360 | PMB-360 | MC360 | PMC-360 |

NOTE: PMA Series **POLY-V** Brake Lines are supplied with Long Nuts for compatibility with Toyota/GM brake line requirements.

**BRAKE LINE MERCHANDISERS
PRÉSENTOIRS TUBULURE DE FREIN**

Each merchandiser includes a rugged metal rack complete with measuring gauge. Merchandisers can be hung on a wall, shelf end, or post. When joining two or more brake lines, use Papco® Inverted Flare Unions.

STEEL BRAKE LINE MERCHANDISERS**No. 022-079**

Contains 48 Lengths of the most popular 5/16" and 3/8" diameter Steel Brake Lines. Four each of 5/16" and 3/8 x 12", 20", 30", 40", 51" and 60".

No. 022-080

Contains 56 Lengths of the most popular 3/16" and 1/4" diameter Steel Brake Lines. Four each of 3/16" and 1/4 x 8", 12", 20", 30", 40", 51" and 60".

ARMOURED STEEL BRAKE LINE MERCHANDISERS**No. 022-081**

Contains 56 lengths of the most popular 3/16" and 1/4" diameter Armoured Brake Lines. Four each of 3/16" and 1/4"x 8", 12", 20", 30", 40", 51" and 60".

No. 022-082

Contains 48 lengths of the most popular 5/16" and 3/8" diameter Armoured Brake Lines. Four each of 5/16" and 3/8"x 12", 20", 30", 40", 51" and 60".

POLY-V COATED BRAKE LINE MERCHANDISER**No. 022-587**

Contains 56 Lengths of the most popular 3/16" and 1/4" diameter Coated Brake Lines. Four each of 3/16" and 1/4 x 8", 12", 20", 30", 40", 51" and 60".

No. 022-588

Contains 48 Lengths of **POLY-V** Coated Brake Lines. Four each of 5/16" and 3/8 x 12", the most popular 5/16" and 3/8" diameter 20", 30", 40", 51" and 60".

STEEL METRIC BRAKE LINE MERCHANDISER**No. 022-483**

Contains 42 lines - three of each of the 14 listed lengths of Steel Metric Brake Lines in Type 'A' and 'C'.

No. 022-484

Contains 42 lines - three of each of the 14 listed lengths of Steel Metric Brake Lines for Toyota and GM/Imports.

POLY-V COATED METRIC BRAKE LINE MERCHANDISER**No. 022-485**

Contains 42 lines - three of each of the 14 listed lengths of Poly-V coated Metric Brake Lines in Type 'A' and 'C'.

EMPTY BRAKE LINE RACKS**No. 022-077**

For 3/16" and 1/4" Dia. Brake Lines.

No. 022-078

For 5/16" and 3/8" Dia. Brake Lines.

METRIC BRAKE AND FUEL LINE DOMESTIC/EUROPEAN**No. 022-077MA****METRIC BRAKE AND FUEL LINE TOYOTA/GM****No. 022-077MT****BRAKE LINE ADAPTOR LINES (STANDARD AND METRIC)****No. 022-077AL**



BRAKE LINE TUBING TUYAU DE FREIN



| S - STEEL | P - POLY-V | CN - COPPER NICKEL | | |
|-----------------------|------------|--------------------|---------------|-------------------------------|
| ORDER BY STOCK NUMBER | | | | Standard coil length - 25 ft. |
| Outside Dia. | Steel | POLY-V | COPPER NICKEL | Wall thickness |
| 3/16 | 901-131 | PC-325 | CN-325 | 0.28 |
| 1/4 | 901-141 | PC-425 | CN-425 | |
| 5/16 | 901-151 | PC-525 | CN-525 | |
| 3/8 | 901-161 | PC-625 | CN-625 | |

COPPER TUBING

Construction: Cold drawn to size, seamless and fully annealed alloy. Advantages: Soft temper permits single and double flares as well as easy hand shaping. Applications: Suitable for refrigeration, gasoline and oil lines on automobiles, trucks, marine and diesel engines, oil burners, water lines, industrial and general purpose use. Available in 25*, 50 and 100 foot coils.

ORDER BY STOCK NUMBER

| Stock No. | | | Outside Dia. | Wall Thick. | Weight Per 100 ft. | W/P psi @100°F |
|-----------|---------|---------|--------------|-------------|--------------------|----------------|
| 25 ft. | 50 ft. | 100 ft. | | | | |
| 901-221 | 901-222 | 901-223 | 1/8 | .030 | 3.5 lbs. | 3130 |
| 901-231 | 901-232 | 901-233 | 3/16 | .030 | 5.8 lbs. | 1990 |
| 901-241 | 901-242 | 901-243 | 1/4 | .030 | 8.0 lbs. | 1450 |
| 901-251 | 901-252 | 901-253 | 5/16 | .032 | 11.0 lbs. | 1230 |
| 901-261 | 901-262 | 901-263 | 3/8 | .032 | 13.4 lbs. | 900 |
| 901-271 | 901-272 | 901-273 | 1/2 | .032 | 18.2 lbs. | 740 |
| 901-281 | 901-282 | 901-283 | 5/8 | .035 | 23.2 lbs. | 640 |
| 901-291 | 901-292 | 901-293 | 3/4 | .035 | 28.0 lbs. | 640 |

* Individually Packaged up to 3/8 O.D.

W/P - Working Pressure

HYDRAULIC BRAKE FITTINGS RACCORDS DE FREINS HYDRAULIQUES

8" MASTER CYLINDER ADAPTOR LINES (COLOUR CODED)

INDIVIDUALLY PACKAGED

| Steel | POLY-V | Tube size | Thread & Flared Type | Thread & Flared Type | Colour Code |
|----------|------------|-----------|----------------------|----------------------|-------------|
| 913-001 | P913-001 | 1/4 | 7/16-24 - Inverted | 7/16-24 - Inverted | Gold |
| 913-002* | P913-002 ✓ | 3/16 | 3/8-24 - Inverted | 7/16-24 - Inverted | Red |
| 913-003* | P913-003 ✓ | 3/16 | 3/8-24 - Inverted | 1/2-20 - Inverted | Black |
| 913-004* | P913-004 ✓ | 3/16 | 3/8-24 - Inverted | 1/2-20 - Inverted | Green |
| 913-005* | P913-005 ✓ | 1/4 | 7/16-24 - Inverted | 9/16-18 - Inverted | Blue |
| 913-006* | P913-006 ✓ | 3/16 | 3/8-24 - Inverted | 9/16-18 - Inverted | Olive |
| 913-007* | P913-007 ✓ | 1/4 | 7/16-24 - Inverted | 1/2-20 - Inverted | Gold |
| 913-008* | P913-008 ✓ | 3/16 | 3/8-24 - Inverted | 10mm-1.0 - Bubble | Olive |
| 913-009* | P913-009 ✓ | 3/16 | 10mm-1.0 - Bubble | 11mm-1.0 - Bubble | Orange |
| 913-010* | P913-010 ✓ | 3/16 | 10mm-1.0 - Bubble | 12mm-1.0 - Bubble | Orange |
| 913-011* | P913-011 ✓ | 3/16 | 10mm-1.0 - Bubble | 13mm-1.0 - Bubble | Green |
| 913-012* | P913-012 ✓ | 3/16 | 3/8-24 - Inverted | 11mm-1.0 - Bubble | Orange |
| 913-013* | P913-013 ✓ | 3/16 | 3/8-24 - Inverted | 12mm-1.0 - Bubble | Blue |
| 913-014* | P913-014 ✓ | 3/16 | 3/8-24 - Inverted | 13mm-1.5 - Bubble | Green |
| 913-015* | P913-015 ✓ | 3/16 | 3/8-24 - Inverted | 10mm-1.0 - Inverted | Blue |
| 913-016 | P913-016 | 1/4 | 7/16-24 - Inverted | 12mm-1.0 - Bubble | Olive |
| 913-017 | P913-017 | 6 mm | 12mm-1.0 - Bubble | 12mm-1.5 - Bubble | Olive |
| 913-018 | P913-018 | 6 mm | 12mm-1.0 - Bubble | 14mm-1.5 - Bubble | Black |



STEEL MASTER CYLINDER ADAPTOR LINES

ASSORTMENT NO. 022-845

Contains a total of 28 Adaptor Lines 2 each of the 14 most popular sizes as indicated above (*)



POLY-V COATED STEEL MASTER CYLINDER ADAPTOR LINES

ASSORTMENT NO. 022-846

Contains a total of 28 POLY-V Adaptor Lines 2 each of the 14 most popular sizes as indicated above (✓)



**BRAKE LINE FITTINGS
RACCORDS POUR CONDUITES DE FREINS**

STEEL TUBE NUTS – STANDARD

Standard Package 10 Pieces

| Part No. | Tube size | Thread size |
|----------|-----------|-------------|
| DS141-3 | 3/16 | 3/8-24 |
| DS141-4 | 1/4 | 7/16-24 |
| DS141-5 | 5/16 | 1/2-20 |
| DS141-6 | 3/8 | 5/8-18 |



STEEL TUBE NUTS – LONG

Standard Package 10 Pieces

| Part No. | Tube size | Thread size |
|----------|-----------|-------------|
| DSL141-3 | 3/16 | 3/8-24 |
| DSL141-4 | 1/4 | 7/16-24 |



STEEL TUBE NUTS – OVERSIZE HEX

Standard Package 10 Pieces

| Part No. | Tube size | Thread size |
|-----------|-------------|-------------|
| DS141-4-3 | 1/4 x 3/16 | 7/16-24 |
| DS141-5-3 | 5/16 x 3/16 | 1/2-20 |
| DS141-5-4 | 5/16 x 1/4 | 1/2-20 |
| DS141-6-3 | 3/8 x 3/16 | 5/8-18 |
| DS141-6-4 | 3/8 x 1/4 | 5/8-18 |



UNIONS

Standard Package 10 Pieces

| Part No. | Tube size | Thread size |
|----------|-----------|-------------|
| D142-3 | 3/16 | 3/8-24 |
| D142-4 | 1/4 | 7/16-24 |
| D142-5 | 5/16 | 1/2-20 |
| D142-6 | 3/8 | 5/8-18 |



BRAKE BLEEDER SCREWS

Standard Package 5 Pieces

| Part No. | Size | Application | Type |
|----------|---------------------|------------------------------|------|
| 904-200 | 3/8-24 x 1.51" | Ford | 1 |
| 904-201 | M10-1.0 x 27.5mm | GM / Ford | 3 |
| 904-203 | 3/8-24 x 1.19" | GM / Ford / Chrysler / Jeep | 1 |
| 904-204 | M8-1.25 x 33mm | GM / Honda | 3 |
| 904-205 | M8-1.25 x 25.2mm | GM / Honda / Acura | 2 |
| 904-206 | 1/4-28 x .920" | Ford / Volvo | 1 |
| 904-207 | M10-1.5 x 29.3mm | GM | 2 |
| 904-209 | M7-1.0 x 34mm | Domestic / Import | 1 |
| 904-210 | M10-1.0 x 35.2mm | Domestic / Import | 2 |
| 904-211 | M10-1.0 x 36.7mm | Toyota / Lexus | 2 |
| 904-212 | M10-1.0 x 32.75mm | Domestic / Import | 1 |
| 904-213 | 5/16-24 x 1.01" | GM | 1 |
| 904-214 | M7-1.0 x 37.6mm | Most Import | 1 |
| 904-215 | 7/16-20 x 1.26 | Ford | 2 |
| 904-216 | M8-1.0 x 37.3mm | Ford/Mazda/Geo/Isuzu | 1 |
| 904-218 | Small Repair Insert | Universal - stripped threads | 2 |
| 904-219 | Large Repair Insert | Universal - stripped threads | 2 |
| 904-221 | M10-1.25 x 33.1mm | Domestic / Import | 2 |
| 904-230 | M8-1.0 x 26.4mm | Domestic / Import | 2 |



**BRAKE BLEEDER SCREWS
MASTER ASSORTMENT**

No. 020-604

Contains 64 pieces –
See page 7 for more details.



ADAPTORS – STANDARD TO DUAL MASTER CYLINDER

Standard Package 2 Pieces

| Part No. | Female Inverted Flare Seat - Thread | Male Inverted Flare Seat - Thread | Part No. | Female Inverted Flare Seat - Thread | Male Inverted Flare Seat - Thread |
|----------|-------------------------------------|-----------------------------------|----------|-------------------------------------|-----------------------------------|
| D1074* | 5/16 - 1/2-20 | 5/16 - 1/2-20 | D7910 | 3/16 - 3/8-24 | 3/16 - 9/16-20 |
| D7732* | 1/4 - 7/16-24 | 1/4 - 7/16-20 | D7911 | 3/16 - 3/8-24 | 3/16 - 9/16-18 |
| D7817* | 3/16 - 3/8-24 | 5/16 - 1/2-20 | D7912 | 3/16 - 9/16-18 | 3/16 - 1/2-20 |
| D7818 | 3/16 - 3/8-24 | 1/4 - 7/16-24 | D7913 | 3/16 - 1/2-20 | 3/16 - 9/16-18 |
| D7828 | 1/4 - 7/16-24 | 3/16 - 3/8-24 | D7915 | 3/8 - 5/8-18 | 5/16 - 1/2-20 |
| D7829 | 1/4 - 7/16-24 | 5/16 - 1/2-20 | D7916 | 5/16 - 1/2-20 | 3/8 - 5/8-18 |
| D7908 | 1/4 - 7/16-24 | 3/16 - 9/16-18 | D7917* | 5/16 - 1/2-20 | 1/4 - 7/16-24 |
| D7909 | 3/16 - 3/8-24 | 5/16 - 1/2-20 | | | |



* Seals on hex face



BRAKE LINE FITTINGS RACCORDS POUR CONDUITES DE FREINS

METRIC BRAKE LINE FLARE NUTS

Standard Package 10 Pieces

| Steel | Tube size | Flare Type | Thread-Application | Colour Code |
|-------|-----------|----------------|--------------------------|-------------|
| MA300 | 3/16 | Inverted Flare | 10mm-1.0 - Toyota | Blue |
| MA317 | 3/16 | Inverted Flare | 10mm-1.0 - Toyota/GM | Blue |
| MA327 | 3/16 | Inverted Flare | 10mm-1.0 - Toyota | Blue |
| MA343 | 3/16 | Inverted Flare | 10mm-1.0 - Japanese | Blue |
| MB311 | 3/16 | Bubble Flare | 3/8-24 - British | Violet |
| MC300 | 3/16 | Bubble Flare | 10mm-1.0 - Euro/Domestic | Olive |
| MC313 | 1/4 | Inverted Flare | 12mm-1.0 - Ford | Olive |
| MC314 | 3/16 | Bubble Flare | 10mm-1.0 - VW/Audi | Violet |
| MC341 | 3/16 | Bubble Flare | 12mm-1.0 - GM/Ford | Blue |
| MC342 | 3/16 | Bubble Flare | 13mm-1.5 - GM/Ford | Green |
| MC343 | 3/16 | Bubble Flare | 11mm-1.5 - GM/Ford | Orange/Grey |
| MC612 | 6 mm | Bubble Flare | 12mm-1.0 | Olive |
| MC613 | 6 mm | Bubble Flare | 12mm-1.5 | Olive |
| MC614 | 6 mm | Bubble Flare | 14mm-1 | Black |



METRIC / INCH INVERTED FLARE AND BUBBLE FLARE UNIONS

Standard Package 2 Pieces

| Part No. | Tube Size | Thread Size | Seat Type |
|----------|-----------|-------------|----------------|
| PC1190 | 3/16 | 3/8-24 | Bubble Fare |
| PC1191 | 3/16 | M10-1.0 | Bubble Fare |
| PC1192 | 3/16 | M10-1.0 | Inverted Flare |
| PC1193 | M6 | M12-1.0 | Inverted Flare |



ADAPTORS – METRIC TO METRIC BUBBLE FLARE

Standard Package 2 Pieces

| Part No. | Tube Size | Female Bubble Flare Seat | Male Bubble Flare Tube |
|----------|-----------|--------------------------|------------------------|
| PC1179 | 3/16 | M10-1.0 | M11-1.5 |
| PC1180 | 3/16 | M10-1.0 | M12-1.0 |
| PC1181 | 3/16 | M10-1.0 | M13-1.5 |



ADAPTORS – INVERTED FLARE TO INCH / METRIC BUBBLE FLARE

Standard Package 2 Pieces

| Part No. | Tube Size | Female Inverted Flare Seat | Male Bubble Flare Tube |
|----------|-----------|----------------------------|------------------------|
| PC1177 | 3/16 | 3/8-24 | 3/8-24 |
| PC1178 | 3/16 | 3/8-24 | M10-1.0 |



ADAPTORS – INVERTED FLARE TO METRIC BUBBLE FLARE

Standard Package 2 Pieces

| Part No. | Tube Size | Female Inverted Flare Sea | Male Inverted Flare Tube |
|----------|-----------|---------------------------|--------------------------|
| PC1176 | 3/16 | 3/8-24 | M10-1.0 |



HYDRAULIC GREASE FITTINGS GRAISSEURS HYDRAULIQUE

Papco® Hydraulic Grease Fittings are manufactured from high-quality, case hardened steel and are zinc plated to resist corrosion. Each fitting is heat treated and tested to 8,000 p.s.i. Spring-loaded ball check valve ensures a dirt-free lubrication system. Papco® Grease Fittings are available in all popular thread types including thread-forming and metric.

ORDER BY STOCK NUMBER

Standard Package: 25 Pieces

| Type 1 Straight | Type 2 30° Elbow | Type 3 45° Elbow | Type 4 65° Elbow | Type 5 90° Elbow | Type 6 Thread-Forming | Type 7 Straight Long |
|--------------------|---------------------|-----------------------|---------------------|---------------------|--------------------------|-------------------------|
| Stock No. | Type | Description | Stock No. | Type | Description | |
| 904-607 | 7 | 1/8 NPT Straight Long | 904-691 | 5 | 1/4-28 90° Elbow | |
| 904-610 | 1 | 1/8 NPT Straight | 904-692 | 1 | 5/16-24 Straight | |
| 904-611 | 2 | 1/8 NPT 30° Elbow | 904-693 | 1 | 3/8-24 Straight | |
| 904-688 | 3 | 1/8 NPT 45° Elbow | 904-690 | 6 | 1/4-28 Thread-Forming | |
| 904-612 | 4 | 1/8 NPT 65° Elbow | Metric Fittings | | | |
| 904-613 | 5 | 1/8 NPT 90° Elbow | 904-701 | 1 | 6 mm x 1.0 Straight | |
| 904-627 | 1 | 1/4 NPT Straight | 904-745 | 3 | 6 mm x 1.0 45° Elbow | |
| 904-629 | 4 | 1/4 NPT 65° Elbow | 904-790 | 5 | 6 mm x 1.0 90° Elbow | |
| 904-641 | 1 | 1/4-28 Straight | 904-702 | 1 | 8 mm x 1.0 Straight | |
| 904-652 | 7 | 1/4-28 Straight Long | 904-746 | 3 | 8 mm x 1.0 45° Elbow | |
| 904-636 | 3 | 1/4-28 45° Short | 904-791 | 5 | 8 mm x 1.0 90° Elbow | |
| 904-637 | 3 | 1/4-28 45° Long | 904-703 | 1 | 10 mm x 1.0 Straight | |

GREASE FITTINGS MASTER ASSORTMENT

No. 020-685

Contains 160 pieces of 17 popular sizes.
Packed in a rigid all metal box.

GREASE FITTINGS ASSORTMENT

No. 020-901 (Inch)

No. 020-902 (Metric)

Each assortment contains 100 Grease Fittings
in 6 popular sizes.

ORDER BY STOCK NUMBER

| Stock No. | Pieces | Stock No. | Pieces |
|-------------|--------|-------------|--------|
| No. 020-901 | Inch | No. 020-902 | Metric |
| 904-641 | 60 | 904-701 | 40 |
| 904-610 | 20 | 904-702 | 20 |
| 904-637 | 6 | 904-703 | 10 |
| 904-691 | 6 | 904-745 | 10 |
| 904-688 | 4 | 904-746 | 10 |
| 904-613 | 4 | 904-790 | 10 |



AN INTRODUCTION TO...

BUILDERS' & AGRICULTURAL FASTENERS

ATTACHES POUR L'AGRICULTURE

...UNE INTRODUCTION.

www.hpaulin.com

For a full listing of Builders', & Agricultural Fasteners please refer to our current catalogue or visit our website to download a PDF version.



**BUILDERS' & AGRICULTURAL
HARDWARE MERCHANDISER**

HOOKS & EYE BOLTS

LAG THREAD SCREW EYES

LIFTING EYES

J-BOLTS

U-BOLTS

TURNBUCKLES & S-HOOKS

**WIRE ROPE CLIPS
& THIMBLES**

WELDED RINGS & DEES

BOLT SNAPS & SWIVELS

SPRING & ANIMAL SNAPS

SNAPS & PULLEYS

CHAIN HOOKS & LATCHES

CONNECTION HARDWARE

LINKS & CHAIN SWIVELS

**ROPE LOOPS, CLEATS
& CLAMPS**

ROPE ACCESSORIES

LOCK PINS

HITCH PINS

**SHAFT COLLARS &
MACHINERY BUSHINGS**

**METRIC SHAFT COLLARS
& HITCH PIN CLIPS**

DISPLAY BOARDS



BUILDERS' & AGRICULTURAL HARDWARE MERCHANDISER
PRÉSENTOIR DE QUINCAILLERIE DE BÂTIMENTS ET POUR L'AGRICULTURE



Empty Merchandiser Rack No. 022-001
 38"W x 38"D x 75"H

papeco[®] **DISPLAY BOARDS**

Choose from 46 product display boards to customize your own 36 panel merchandiser. Empty rack No. 022-001 is supplied at no charge with any order of 36 panels. Each panel is 12 inches wide and 21 inches long and includes an actual size graphic of each product for ease of placement and display hooks.

EMPTY MERCHANDISER RACK NO. 022-001

Durable, free-standing unit includes 4 casters for effort-free positioning. Holds 36 display panels and measures 38 inches wide by 38 inches deep by 75 inches tall.

FEATURES

- Highly visible and accessible products
- Space saving rack
- Neatly organized presentation of product
- Helps increase sales
- All items individually bar-coded

For our complete line of Builders' and Agricultural Fasteners see our most current catalogue.

PANEL ASSORTMENT INDEX

| Part No. | Panel No. | Description | Panel Size |
|----------|-----------|--|------------|
| 996450 | 2 | Screw Hooks Large | 12" x 21" |
| 996452 | 4 | Lag Thread Screw Eyes Large | 12" x 21" |
| 996453 | 5 | Lag Thread Screw Eyes & Ceiling Hooks – Brass Finish | 12" x 21" |
| 996458 | 10 | Eye Bolts Extra Large A | 12" x 21" |
| 996459 | 11 | Eye Bolts Extra Large B | 12" x 21" |
| 996460 | 12 | Eye Bolts Extra Large C | 12" x 21" |
| 996461 | 13 | Eye Bolts Extra Large D | 12" x 21" |
| 996462 | 14 | Forged Steel Eye Bolts Plain – Galvanized | 12" x 21" |
| 996463 | 15 | Forged Steel Eye Bolts With Shoulder – Galvanized | 12" x 21" |
| 996464 | 16 | Forged Steel Lifting Eyes – Self Colored | 12" x 21" |
| 996465 | 17 | Clothesline Hooks & J-Bolts | 12" x 21" |
| 996467 | 19 | U-Bolts Large A | 12" x 21" |
| 996468 | 20 | U-Bolts Large B | 12" x 21" |
| 996469 | 21 | Square U-Bolts | 12" x 21" |
| 996470 | 22 | Square U-Bolts – Lumber Sized | 12" x 21" |
| 996471 | 23 | Turnbuckles – Hook & Hook | 12" x 21" |
| 996472 | 24 | Turnbuckles – Eye & Eye | 12" x 21" |
| 996473 | 25 | Turnbuckles – Hook & Eye | 12" x 21" |
| 996474 | 26 | Turnbuckles – E&E and H&E Combination | 12" x 21" |
| 996475 | 27 | Forged/Galvanized Turnbuckles – Hook & Eye | 12" x 21" |
| 996476 | 28 | Forged/Galvanized Turnbuckles – Eye & Eye | 12" x 21" |
| 996478 | 30 | Wire Rope Clips & Thimbles Large | 12" x 21" |
| 996479 | 31 | Welded Rings and Dees | 12" x 21" |
| 996480 | 32 | Bolt Snaps & Swivels | 12" x 21" |
| 996481 | 33 | Spring and Animal Snaps | 12" x 21" |
| 996482 | 34 | Brass Snaps | 12" x 21" |
| 996483 | 35 | Awning Pulleys | 12" x 21" |
| 996484 | 36 | Heavy Duty Pulleys | 12" x 21" |
| 996485 | 37 | Forged/Zinc Eye Type Chain Hooks | 12" x 21" |
| 996486 | 38 | Forged/Zinc Clevis Type Chain Hooks | 12" x 21" |
| 996487 | 39 | Chain Hooks with Latches | 12" x 21" |
| 996488 | 40 | Forged G70 Chain Hooks | 12" x 21" |
| 996489 | 41 | Forged/Galvanized Connection Hardware | 12" x 21" |
| 996490 | 42 | Links and Chain Swivels | 12" x 21" |
| 996491 | 43 | Rope Loops, Cleats, Clamps & Hooks | 12" x 21" |
| 996492 | 44 | Rope Accessories | 12" x 21" |
| 996493 | 45 | Stainless Steel Eye Bolts, Lag Eyes & Hooks | 12" x 21" |
| 996494 | 46 | Stainless Steel U-Bolts | 12" x 21" |
| 996495 | 47 | Stainless Steel Turnbuckles, Screw Eyes & S Hooks | 12" x 21" |
| 996496 | 48 | Stainless Steel Links, Snaps & Hooks | 12" x 21" |
| 996497 | 49 | Bolts Snaps, Spring Snaps & Animal Snaps Combination | 12" x 21" |
| 996502 | 55 | Hitch Pins – Zinc & Yellow | 12" x 21" |
| 996503 | 56 | Hitch Pins – Zinc & Yellow Part 2 | 12" x 21" |
| 996504 | 57 | Hitch Pins – Rubber Handle | 12" x 21" |
| 996505 | 58 | Hitch Pins – Rubber Handle Part 2 | 12" x 21" |
| 996506 | 59 | Lock Pins – Square, Round & Spring | 12" x 21" |
| 996507 | 60 | Shaft Collars & Machinery Bushings | 12" x 21" |
| 996508 | 61 | Metric Shaft Collars & Hitch Pins Clips | 12" x 21" |
| 996499 | 50 | Blank Black 12" x 21" | 12" x 21" |
| 996501 | 51 | Blank Grey 12" x 21" | 12" x 21" |

Screw Hooks LARGE

Panel 2 — 996450

Total SKUs: 17

| Part # | Description |
|--------|------------------------------------|
| 321220 | Screw Hook Zinc .307 x 4-15/16 |
| 321222 | Screw Hook Zinc .263 x 4-7/16 |
| 321224 | Screw Hook Zinc .244 x 4-1/8 |
| 321226 | Screw Hook Zinc .225 x 3-7/8 |
| 321228 | Screw Hook Zinc .192 x 3-3/8 |
| 321238 | Screw Hook Brass .244 x 4-7/16 |
| 321240 | Screw Hook Brass .207 x 4-1/8 |
| 321242 | Screw Hook Brass .192 x 3-5/8 |
| 321244 | Screw Hook Brass .162 x 3-3/8 |
| 321246 | Screw Hook Brass .162 x 2-9/16 |
| 321248 | Screw Hook Brass .135 x 2-1/16 |
| 321254 | Heavy Duty Screw Hook 3/8 x 10 |
| 321253 | Heavy Duty Screw Hook 3/8 x 8 |
| 321808 | Heavy Duty Screw Hook 3/8 x 4-7/8 |
| 851881 | Heavy Duty Screw Hook 3/8 x 4-1/2 |
| 321806 | Heavy Duty Screw Hook 5/16 x 4-1/2 |
| 321804 | Heavy Duty Screw Hook 1/4 x 4-1/4 |
| 996450 | Panel 2 – Screw Hooks Large |



Lag Thread Screw Eyes LARGE

Panel 4 — 996452

Total SKUs: 16

| Part # | Description |
|--------|--------------------------------------|
| 320968 | Large Scr Eye Zinc .263 x 2-7/8 |
| 320966 | Large Scr Eye Zinc .307 x 2-7/8 |
| 320964 | Large Scr Eye Zinc .363 x 3-7/8 |
| 321140 | Lag Thread Scr Eye Zinc 1/4 x 3 |
| 321142 | Lag Thread Scr Eye Zinc 1/4 x 3-3/4 |
| 321145 | Lag Thread Scr Eye Zinc 1/4 x 5 |
| 321148 | Lag Thread Scr Eye Zinc 5/16 x 4 |
| 321150 | Lag Thread Scr Eye Zinc 5/16 x 5 |
| 321154 | Lag Thread Scr Eye Zinc 5/16 x 6 |
| 321155 | Lag Thread Scr Eye Zinc 3/8 x 4-1/2 |
| 321156 | Lag Thread Scr Eye Zinc 3/8 x 5-1/2 |
| 321158 | Lag Thread Scr Eye Zinc 3/8 x 6 |
| 321160 | Lag Thread Scr Eye Zinc 3/8 x 8 |
| 321162 | Lag Thread Scr Eye Zinc 7/16 x 5-1/4 |
| 321164 | Lag Thread Scr Eye Zinc 1/2 x 5-1/2 |
| 321166 | Lag Thread Scr Eye Zinc 1/2 x 8 |
| 996452 | Panel 4 – Lag Thread Scr Eye Large |



Brass Lag Thread Screw Eyes & Ceiling Hooks

Panel 5 — 996453

Total SKUs: 19

| Part # | Description |
|--------|--|
| 320954 | Brass Large Scr Eye .192 x 1-15/16 |
| 320952 | Brass Large Scr Eye .225 x 2-3/16 |
| 320950 | Brass Large Scr Eye .307 x 2-7/8 |
| 321180 | Lag Thread Scr Eye Brass Ptd 1/4 x 3-3/4 |
| 321182 | Lag Thread Scr Eye Brass Ptd 1/4 x 5 |
| 321184 | Lag Thread Scr Eye Brass Ptd 5/16 x 4 |
| 321186 | Lag Thread Scr Eye Brass Ptd 5/16 x 6 |
| 321188 | Lag Thread Scr Eye Brass Ptd 3/8 x 4-1/2 |
| 321190 | Lag Thread Scr Eye Brass Ptd 3/8 x 8 |
| 321248 | Screw Hook Brass .135 x 2-1/16 |
| 321246 | Screw Hook Brass .162 x 2-9/16 |
| 321244 | Screw Hook Brass .162 x 3-3/8 |
| 321242 | Screw Hook Brass .192 x 3-5/8 |
| 321238 | Screw Hook Brass .244 x 4-7/16 |
| 322122 | S Hook Zinc .272 x 2-3/4 |
| 322124 | S Hook Zinc .307 x 3 |
| 322138 | S Hook Brass Plated .250 x 2-1/4 |
| 322140 | S Hook Brass Plated .272 x 2-3/4 |
| 322142 | S Hook Brass Plated .307 x 3 |
| 996453 | Panel 5 – Brass Lag Eyes & Hooks |



Stainless Steel Eye Bolts & Hooks

Panel 45 — 996493

Total SKUs: 20

| Part # | Description |
|--------|------------------------------------|
| 851882 | SS Eye Bolt w/ Nut 3/16 x 1-1/2 |
| 320754 | SS Eye Bolt w/ Nut 3/16 x 2 |
| 320756 | SS Eye Bolt w/ Nut 1/4-20 x 2 |
| 320758 | SS Eye Bolt w/ Nut 1/4-20 x 2-5/8 |
| 320760 | SS Eye Bolt w/ Nut 1/4-20 x 3 |
| 320762 | SS Eye Bolt w/ Nut 1/4-20 x 4 |
| 320764 | SS Eye Bolt w/ Nut 5/16-18 x 3-1/4 |
| 320766 | SS Eye Bolt w/ Nut 5/16-18 x 4 |
| 851883 | SS Eye Bolt w/ Nut 5/16-18 x 5 |
| 320768 | SS Eye Bolt w/ Nut 3/8-16 x 3-7/8 |
| 851884 | SS Eye Bolt w/ Nut 3/8-16 x 5 |
| 320770 | SS Eye Bolt w/ Nut 3/8-16 x 6 |
| 320772 | SS Eye Bolt w/ Nut 3/8-16 x 8 |
| 321168 | SS Lag Thread Scr Eye 1/4 x 3-3/4 |
| 321170 | SS Lag Thread Scr Eye 1/4 x 5 |
| 321172 | SS Lag Thread Scr Eye 5/16 x 4 |
| 321174 | SS Lag Thread Scr Eye 3/8 x 4-1/2 |
| 851879 | SS Heavy Duty Scr Hook 1/4 x 4-1/4 |
| 851880 | SS Heavy Duty Scr Hook 3/8 x 4-7/8 |
| 852441 | SS Clothes Hook 5/16 x 5 |
| 996493 | Panel 45 – SS Eye Bolts & Hooks |



Eye Bolts with Hex Nuts EXTRA LARGE A

Panel 10 — 996458

Total SKUs: 13

Panels 10, 11, 12 and 13 should be merchandised together.

| Part # | Description |
|--------|-------------------------------------|
| 320700 | Eye Bolt w/ Nut Zinc 10-24 x 1-1/2 |
| 320702 | Eye Bolt w/ Nut Zinc 10-24 x 2 |
| 320704 | Eye Bolt w/ Nut Zinc 10-24 x 2-1/2 |
| 320706 | Eye Bolt w/ Nut Zinc 1/4-20 x 2 |
| 320708 | Eye Bolt w/ Nut Zinc 1/4-20 x 2-1/2 |
| 320710 | Eye Bolt w/ Nut Zinc 1/4-20 x 3 |
| 320718 | Eye Bolt w/ Nut Zinc 1/4-20 x 8 |
| 320728 | Eye Bolt w/ Nut Zinc 5/16-18 x 5 |
| 320730 | Eye Bolt w/ Nut Zinc 5/16-18 x 6 |
| 320732 | Eye Bolt w/ Nut Zinc 5/16-18 x 8 |
| 320738 | Eye Bolt w/ Nut Zinc 3/8-16 x 5 |
| 320740 | Eye Bolt w/ Nut Zinc 3/8-16 x 6 |
| 320742 | Eye Bolt w/ Nut Zinc 3/8-16 x 8 |
| 996458 | Panel 10 – Eye Bolts Extra Large A |

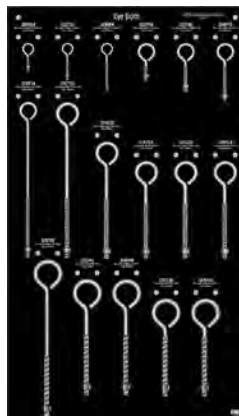

Eye Bolts with Hex Nuts EXTRA LARGE B

Panel 11 — 996459

Total SKUs: 7

Panels 10, 11, 12 and 13 should be merchandised together.

| Part # | Description |
|--------|--------------------------------------|
| 320712 | Eye Bolt w/ Nut Zinc 1/4-20 x 4 |
| 320714 | Eye Bolt w/ Nut Zinc 1/4-20 x 5 |
| 320716 | Eye Bolt w/ Nut Zinc 1/4-20 x 6 |
| 320722 | Eye Bolt w/ Nut Zinc 5/16-18 x 3-1/4 |
| 320724 | Eye Bolt w/ Nut Zinc 5/16-18 x 4 |
| 320734 | Eye Bolt w/ Nut Zinc 3/8-16 x 2-1/2 |
| 320736 | Eye Bolt w/ Nut Zinc 3/8-16 x 4 |
| 996459 | Panel 11 – Eye Bolts Extra Large B |



**Eye Bolts with Hex Nuts
EXTRA LARGE C**

Panel 12 – 996460

Total SKUs: 7

Panels 10, 11, 12 and 13 should be merchandised together.

| Part # | Description |
|--------|---------------------------------------|
| 320748 | Eye Bolt w/ Nut Zinc 1/2-13 x 8 |
| 320750 | Eye Bolt w/ Nut Zinc 1/2-13 x 10 |
| 320752 | Eye Bolt w/ Nut Zinc 1/2-13 x 12 |
| 320774 | Eye Bolt w/ Nut Zinc 5/8-11 x 6 |
| 321796 | Clothes Hook Bolt Zinc 5/16-18 x 6 |
| 321798 | Clothes Hook Bolt Zinc 3/8-16 x 7-1/4 |
| 321800 | Clothes Hook Bolt Zinc 3/8-16 x 8-1/4 |
| 996460 | Panel 12 – Eye Bolts Extra Large C |

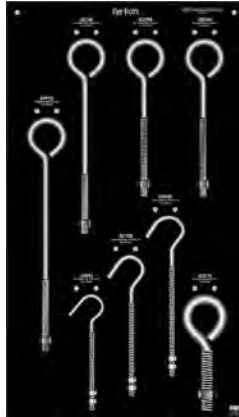

**Eye Bolts with Hex Nuts
EXTRA LARGE D**

Panel 13 – 996461

Total SKUs: 6

Panels 10, 11, 12 and 13 should be merchandised together.

| Part # | Description |
|--------|------------------------------------|
| 320744 | Eye Bolt w/ Nut Zinc 1/2-13 x 4 |
| 320746 | Eye Bolt w/ Nut Zinc 1/2-13 x 6 |
| 320775 | Eye Bolt w/ Nut Zinc 5/8-11 x 8 |
| 320776 | Eye Bolt w/ Nut Zinc 5/8-11 x 10 |
| 320777 | Eye Bolt w/ Nut Zinc 5/8-11 x 12 |
| 320778 | Eye Bolt w/ Nut Zinc 5/8-11 x 14 |
| 996461 | Panel 13 – Eye Bolts Extra Large D |



**Forged Steel Eye Bolts Plain
– Galvanized**

Panel 14 – 996462

Total SKUs: 9

| Part # | Description |
|--------|---|
| 320800 | Frgd/Galv Eye Bolt w/ Nut 1/4-20 x 3-1/8 |
| 320802 | Frgd/Galv Eye Bolt w/ Nut 1/4-20 x 5 |
| 320804 | Frgd/Galv Eye Bolt w/ Nut 5/16-18 x 3-5/8 |
| 320806 | Frgd/Galv Eye Bolt w/ Nut 5/16-18 x 5-1/2 |
| 320808 | Frgd/Galv Eye Bolt w/ Nut 3/8-16 x 4 |
| 320810 | Frgd/Galv Eye Bolt w/ Nut 3/8-16 x 6 |
| 320812 | Frgd/Galv Eye Bolt w/ Nut 1/2-13 x 8 |
| 320814 | Frgd/Galv Eye Bolt w/ Nut 1/2-13 x 10 |
| 320816 | Frgd/Galv Eye Bolt w/ Nut 1/2-13 x 12 |
| 996462 | Panel 14 – Forged Eye Bolts Plain |

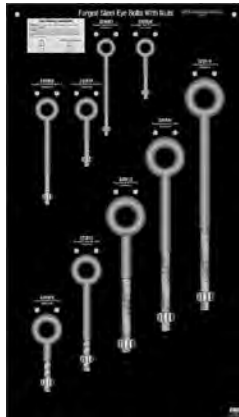

**Forged Steel Eye Bolts
w/Shoulder – Galvanized**

Panel 15 – 996463

Total SKUs: 11

| Part # | Description |
|--------|---|
| 851885 | Frgd/Galv Eye Bolt w/ Shoulder 1/4 x 2 |
| 851886 | Frgd/Galv Eye Bolt w/ Shoulder 1/4 x 4 |
| 851887 | Frgd/Galv Eye Bolt w/ Shoulder 5/16 x 2-1/4 |
| 851888 | Frgd/Galv Eye Bolt w/ Shoulder 5/16 x 4-1/4 |
| 851889 | Frgd/Galv Eye Bolt w/ Shoulder 3/8 x 2-1/2 |
| 851890 | Frgd/Galv Eye Bolt w/ Shoulder 3/8 x 4-1/2 |
| 851891 | Frgd/Galv Eye Bolt w/ Shoulder 3/8 x 6 |
| 851892 | Frgd/Galv Eye Bolt w/ Shoulder 1/2 x 3-1/4 |
| 851893 | Frgd/Galv Eye Bolt w/ Shoulder 1/2 x 6 |
| 851894 | Frgd/Galv Eye Bolt w/ Shoulder 1/2 x 8 |
| 851895 | Frgd/Galv Eye Bolt w/ Shoulder 1/2 x 10 |
| 996463 | Panel 15 – Forged Eye Bolts w/ Shoulder |



Forged Steel Lifting Eyes

Panel 16 – 996464

Total SKUs: 12

| Part # | Description |
|--------|---------------------------------------|
| 320600 | Forged Lifting Eye Bolt Shldr 1/4-20 |
| 320601 | Forged Lifting Eye Bolt Plain 1/4-20 |
| 320602 | Forged Lifting Eye Bolt Shldr 5/16-18 |
| 320603 | Forged Lifting Eye Bolt Plain 5/16-18 |
| 320604 | Forged Lifting Eye Bolt Shldr 3/8-16 |
| 320605 | Forged Lifting Eye Bolt Plain 3/8-16 |
| 320608 | Forged Lifting Eye Bolt Shldr 1/2-13 |
| 320609 | Forged Lifting Eye Bolt Plain 1/2-13 |
| 320610 | Forged Lifting Eye Bolt Shldr 5/8-11 |
| 320611 | Forged Lifting Eye Bolt Plain 5/8-11 |
| 320612 | Forged Lifting Eye Bolt Shldr 3/4-10 |
| 320613 | Forged Lifting Eye Bolt Plain 3/4-10 |
| 996464 | Panel 16 – Forged Lifting Eyes |

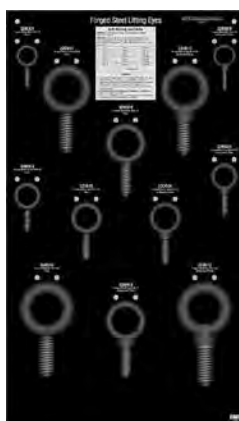

Clothesline Hook & J-Bolts

Panel 17 – 996465

Total SKUs: 15

| Part # | Description |
|--------|--|
| 321780 | J-Bolt w/ Nut Zinc 3/16(10-24) x 1-7/8 |
| 321782 | J-Bolt w/ Nut Zinc 7/32(12-24) x 2-1/8 |
| 321784 | J-Bolt w/ Nut Zinc 1/4-20 x 2-5/16 |
| 851896 | J-Bolt w/ Nut Zinc 1/4-20 x 4 |
| 851897 | J-Bolt w/ Nut Zinc 1/4-20 x 6 |
| 321786 | J-Bolt w/ Nut Zinc 5/16-18 x 3 |
| 851898 | J-Bolt w/ Nut Zinc 5/16 x 5 |
| 851899 | J-Bolt w/ Nut Zinc 5/16 x 7 |
| 321788 | J-Bolt w/ Nut Zinc 3/8-16 x 3-3/4 |
| 321790 | J-Bolt w/ Nut Zinc 3/8-16 x 5 |
| 321792 | J-Bolt w/ Nut Zinc 3/8-16 x 7 |
| 321794 | J-Bolt w/ Nut Zinc 1/2-13 x 6 |
| 321796 | Clothes Hook Bolt Zinc 5/16-18 x 6 |
| 321798 | Clothes Hook Bolt Zinc 3/8-16 x 7-1/4 |
| 321800 | Clothes Hook Bolt Zinc 3/8-16 x 8-1/4 |
| 996465 | Panel 17 – Clothesline Hook & J Bolts |

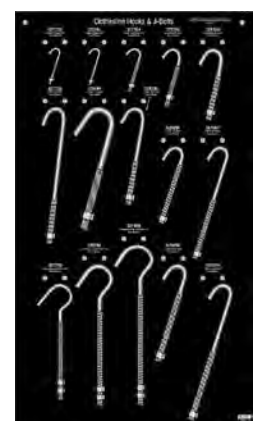

U-Bolts LARGE A

Panel 19 – 996467

Total SKUs: 12

Panels 19 and 20 can be merchandised together. Panel 19 can stand alone as well.

| Part # | Description |
|--------|-------------------------------------|
| 320840 | U-Bolt Zinc 1/4-20 x 2-3/4 x 3/4 |
| 320842 | U-Bolt Zinc 1/4-20 x 2-1/4 x 1-1/8 |
| 320844 | U-Bolt Zinc 1/4-20 x 3-1/2 x 1-1/8 |
| 320846 | U-Bolt Zinc 1/4-20 x 2 3/4 x 1-3/8 |
| 320848 | U-Bolt Zinc 5/16-18 x 2-1/2 x 1-3/8 |
| 320850 | U-Bolt Zinc 5/16-18 x 3-3/4 x 1-3/8 |
| 320852 | U-Bolt Zinc 5/16-18 x 3 x 1-3/4 |
| 320854 | U-Bolt Zinc 5/16-18 x 4-1/4 x 1-3/4 |
| 320856 | U-Bolt Zinc 5/16-18 x 3 x 2 |
| 320858 | U-Bolt Zinc 5/16-18 x 4-13/16 x 2 |
| 320862 | U-Bolt Zinc 5/16-18 x 5 x 2-1/2 |
| 320870 | U-Bolt Zinc 3/8-16 x 4-3/4 x 3-1/2 |
| 996467 | Panel 19 – U-Bolts Large A |

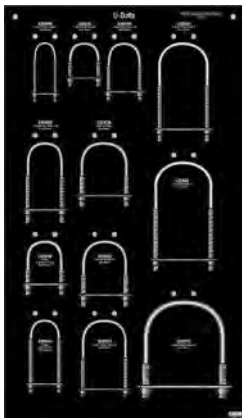

U-Bolts LARGE B

Panel 20 – 996468

Total SKUs: 10

Panels 19 and 20 can be merchandised together.

| Part # | Description |
|--------|-------------------------------------|
| 320828 | U-Bolt Zinc 1/4-20 x 1-3/8 x 9/16 |
| 320830 | U-Bolt Zinc 1/4-20 x 1-1/2 x 3/4 |
| 320832 | U-Bolt Zinc 1/4-20 x 1-3/4 x 1 |
| 320834 | U-Bolt Zinc 1/4-20 x 2-3/4 x 1-3/4 |
| 320836 | U-Bolt Zinc 1/4-20 x 3-1/2 x 2 |
| 320838 | U-Bolt Zinc 1/4-20 x 4 x 3/4 |
| 320860 | U-Bolt Zinc 5/16-18 x 3-1/2 x 2-1/2 |
| 320864 | U-Bolt Zinc 3/8-16 x 3-1/8 x 2 |
| 320866 | U-Bolt Zinc 3/8-16 x 3-5/8 x 2-1/2 |
| 320868 | U-Bolt Zinc 3/8-16x4-1/8 x 3 |
| 996468 | Panel 20 – U-Bolts Large B |

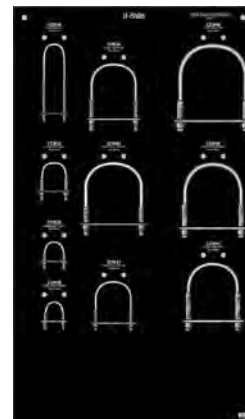

Square U-Bolts

Panel 21 – 996469

Total SKUs: 9

| Part # | Description |
|--------|--------------------------------------|
| 320892 | Square U-Bolt Zinc 5/16-18 x 3 x 2 |
| 320894 | Square U-Bolt Zinc 5/16-18 x 5 x 2 |
| 320896 | Square U-Bolt Zinc 3/8-16 x 7 x 3 |
| 320898 | Square U-Bolt Zinc 3/8-16 x 3 x 4 |
| 320900 | Square U-Bolt Zinc 3/8-16 x 5 x 4 |
| 320902 | Square U-Bolt Zinc 3/8-16 x 6 x 4 |
| 320904 | Square U-Bolt Plate Zinc for 2 Width |
| 320906 | Square U-Bolt Plate Zinc for 3 Width |
| 320908 | Square U-Bolt Plate Zinc for 4 Width |
| 996469 | Panel 21 – Square U-Bolts |



Stainless Steel U-Bolts & Plates

Panel 46 – 996494

Total SKUs: 11

| Part # | Description |
|--------|-----------------------------------|
| 320872 | SS U-Bolt 1/4-20 x 1-3/4 x 1 |
| 320874 | SS U-Bolt 1/4-20 x 2 x 1-1/8 |
| 320876 | SS U-Bolt 1/4-20 x 3-1/2 x 2 |
| 320878 | SS U-Bolt 5/16-18 x 2-1/2 x 1-3/8 |
| 320880 | SS U-Bolt 5/16-18 x 3 x 1-3/4 |
| 320882 | SS U-Bolt 5/16-18 x 3-1/2 x 2-1/2 |
| 852444 | SS U-Bolt 5/16-18 x 4-1/2 x 2 |
| 320884 | SS U-Bolt Plate for 1 & 1-1/8 |
| 320886 | SS U-Bolt Plate for 1-1/2 |
| 320888 | SS U-Bolt Plate for 1-3/4 & 2 |
| 320890 | SS U-Bolt Plate for 2-1/2 |
| 996494 | Panel 46 – SS U-Bolts & Plates |

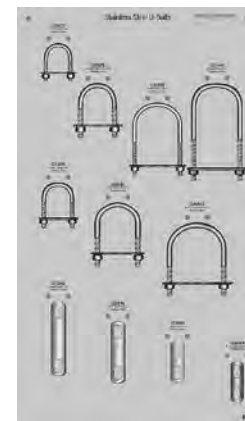

Lumber Sized Square U-Bolts

Panel 22 – 996470

Total SKUs: 4

| Part # | Description |
|--------|--------------------------------------|
| 320909 | Lumber Sized Sq U-Bolt 3/8-16x4x3.63 |
| 320910 | Lumber Sized Sq U-Bolt 3/8-16x5x3.63 |
| 320911 | Lumber Sized Sq U-Bolt 3/8-16x6x3.63 |
| 320912 | Lumber Sized Sq U-Bolt 3/8-16x7x3.63 |
| 996470 | Panel 22 – Lumber Sized U-Bolts |



Hook & Hook Turnbuckles

Panel 23 – 996471

Total SKUs: 8

| Part # | Description |
|--------|---|
| 321914 | H&H Turnbuckle Zinc 5/32(8-32) x 1-1/4 |
| 321916 | H&H Turnbuckle Zinc 3/16(10-24) x 1-5/8 |
| 321918 | H&H Turnbuckle Zinc 7/32(12-24) x 1-7/8 |
| 321920 | H&H Turnbuckle Zinc 1/4-20 x 2-1/8 |
| 321922 | H&H Turnbuckle Zinc 5/16-18 x 2-5/8 |
| 321924 | H&H Turnbuckle Zinc 3/8-16 x 3-1/8 |
| 321926 | H&H Turnbuckle Zinc 3/8-16 x 6 |
| 321928 | H&H Turnbuckle Zinc 1/2-13 x 6 |
| 996471 | Panel 23 – Hook & Hook Turnbuckles |



Eye & Eye Turnbuckles

Panel 24 – 996472

Total SKUs: 8

| Part # | Description |
|--------|---|
| 321840 | E&E Turnbuckle Zinc 5/32(8-32) x 1-1/4 |
| 321842 | E&E Turnbuckle Zinc 3/16(10-24) x 1-5/8 |
| 321844 | E&E Turnbuckle Zinc 7/32(12-24) x 1-7/8 |
| 321846 | E&E Turnbuckle Zinc 1/4-20 x 2-1/8 |
| 321848 | E&E Turnbuckle Zinc 5/16-18 x 2-5/8 |
| 321850 | E&E Turnbuckle Zinc 3/8-16 x 3-1/8 |
| 321852 | E&E Turnbuckle Zinc 3/8-16 x 6 |
| 321854 | E&E Turnbuckle Zinc 1/2-13 x 6 |
| 996472 | Panel 24 – Eye & Eye Turnbuckles |

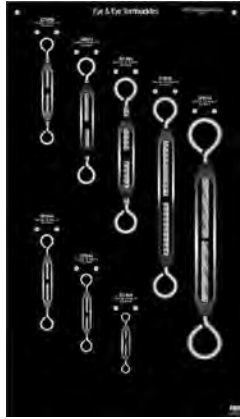

Hook & Eye Turnbuckles

Panel 25 – 996473

Total SKUs: 8

| Part # | Description |
|--------|---|
| 321876 | H&E Turnbuckle Zinc 5/32(8-32) x 1-1/4 |
| 321878 | H&E Turnbuckle Zinc 3/16(10-24) x 1-5/8 |
| 321880 | H&E Turnbuckle Zinc 7/32(12-24) x 1-7/8 |
| 321882 | H&E Turnbuckle Zinc 1/4-20 x 2-1/8 |
| 321884 | H&E Turnbuckle Zinc 5/16-18 x 2-5/8 |
| 321886 | H&E Turnbuckle Zinc 3/8-16 x 3-1/8 |
| 321888 | H&E Turnbuckle Zinc 3/8-16 x 6 |
| 321890 | H&E Turnbuckle Zinc 1/2-13 x 6 |
| 996473 | Panel 25 – Hook & Eye Turnbuckles |



Turnbuckles Combination

Panel 26 – 996474

Total SKUs: 10

| Part # | Description |
|--------|---|
| 321842 | E&E Turnbuckle Zinc 3/16(10-24) x 1-5/8 |
| 321844 | E&E Turnbuckle Zinc 7/32(12-24) x 1-7/8 |
| 321846 | E&E Turnbuckle Zinc 1/4-20 x 2-1/8 |
| 321848 | E&E Turnbuckle Zinc 5/16-18 x 2-5/8 |
| 321850 | E&E Turnbuckle Zinc 3/8-16 x 3-1/8 |
| 321878 | H&E Turnbuckle Zinc 3/16(10-24) x 1-5/8 |
| 321880 | H&E Turnbuckle Zinc 7/32(12-24) x 1-7/8 |
| 321882 | H&E Turnbuckle Zinc 1/4-20 x 2-1/8 |
| 321884 | H&E Turnbuckle Zinc 5/16-18 x 2-5/8 |
| 321886 | H&E Turnbuckle Zinc 3/8-16 x 3-1/8 |
| 996474 | Panel 26 – E&E and H&E Turnbuckles |



Forged Steel Hook & Eye Turnbuckles – Galvanized

Panel 27 – 996475

Total SKUs: 4

| Part # | Description |
|--------|-------------------------------------|
| 321898 | Frgd/Galv H&E Turnbuckle 3/8-16 x 6 |
| 321900 | Frgd/Galv H&E Turnbuckle 1/2-13 x 6 |
| 321902 | Frgd/Galv H&E Turnbuckle 1/2-13 x 9 |
| 321904 | Frgd/Galv H&E Turnbuckle 5/8-11 x 6 |
| 996475 | Panel 27 – Forged H&E Turnbuckles |



Forged Steel Eye & Eye Turnbuckles – Galvanized

Panel 28 – 996476

Total SKUs: 4

| Part # | Description |
|--------|-------------------------------------|
| 321860 | Frgd/Galv E&E Turnbuckle 3/8-16 x 6 |
| 321862 | Frgd/Galv E&E Turnbuckle 1/2-13 x 6 |
| 321864 | Frgd/Galv E&E Turnbuckle 1/2-13 x 9 |
| 321866 | Frgd/Galv E&E Turnbuckle 5/8-11x6 |
| 996476 | Panel 28 – Forged E&E Turnbuckles |



Stainless Steel Turnbuckles, Screw Eyes & S-Hooks

Panel 47 – 996495

Total SKUs: 13

| Part # | Description |
|--------|--|
| 320982 | SS Large Screw Eye 0 x 2-7/8 |
| 320984 | SS Large Screw Eye 4 x 2-3/16 |
| 320986 | SS Large Screw Eye .162 x 1-5/8 |
| 321856 | SS E&E Turnbuckle 10-24 x 1-5/8 |
| 321858 | SS E&E Turnbuckle 1/4-20 x 2-1/8 |
| 321892 | SS H&E Turnbuckle 10-24 x 1-5/8 |
| 321894 | SS H&E Turnbuckle 1/4-20 x 2-1/8 |
| 321896 | SS H&E Turnbuckle 3/8-16 x 3 |
| 322144 | SS S-Hook .177 x 1-1/2 |
| 322146 | SS S-Hook .250 x 2 |
| 322148 | SS S-Hook .307 x 2-1/2 |
| 851845 | SS Large Screw Eye .263 x 2-5/8 |
| 851878 | SS S-Hook .307 x 3 |
| 996495 | Panel 47–SS Turnbuckles-Scr Eyes-S Hooks |



Wire Rope Clips & Thimbles

LARGE

Panel 30 – 996478

Total SKUs: 17

| Part # | Description |
|--------|------------------------------------|
| 852504 | Wire Rope Clip Malleable/Zinc 1/16 |
| 321730 | Wire Rope Clip Malleable/Zinc 1/8 |
| 321732 | Wire Rope Clip Malleable/Zinc 3/16 |
| 321734 | Wire Rope Clip Malleable/Zinc 1/4 |
| 321736 | Wire Rope Clip Malleable/Zinc 5/16 |
| 321738 | Wire Rope Clip Malleable/Zinc 3/8 |
| 321742 | Wire Rope Clip Malleable/Zinc 1/2 |
| 321744 | Wire Rope Clip Malleable/Zinc 5/8 |
| 321746 | Wire Rope Clip Malleable/Zinc 3/4 |
| 322200 | Wire Rope Thimble Steel/Zinc 1/8 |
| 322204 | Wire Rope Thimble Steel/Zinc 3/16 |
| 322206 | Wire Rope Thimble Steel/Zinc 1/4 |
| 322208 | Wire Rope Thimble Steel/Zinc 5/16 |
| 322210 | Wire Rope Thimble Steel/Zinc 3/8 |
| 322212 | Wire Rope Thimble Steel/Zinc 1/2 |
| 322214 | Wire Rope Thimble Steel/Zinc 5/8 |
| 322216 | Wire Rope Thimble Steel/Zinc 3/4 |
| 996478 | Panel 30 – Wire Rope Clips Large |

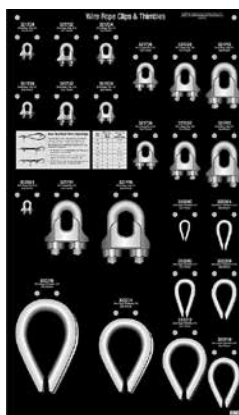

Welded Rings & Dees

Panel 31 – 996479

Total SKUs: 17

| Part # | Description |
|--------|---------------------------------------|
| 321696 | Welded Ring – Steel/Brass 7GA.x3/4 |
| 321698 | Welded Ring – Steel/Brass 7GA.x1 |
| 321700 | Welded Ring – Steel/Brass 7GA.x1-1/4 |
| 321702 | Welded Ring – Steel/Brass 3GA.x1-1/2 |
| 321704 | Welded Ring – Steel/Brass 2GA.x2 |
| 321706 | Welded Ring – Steel/Brass 2GA.x2-1/2 |
| 321708 | Welded Ring – Steel/Nickel 7GA.x3/4 |
| 321710 | Welded Ring – Steel/Nickel 7GA.x1 |
| 321712 | Welded Ring – Steel/Nickel 4GA.x1-1/4 |
| 321714 | Welded Ring – Steel/Nickel 4GA.x1-1/2 |
| 321716 | Welded Ring – Steel/Nickel 2GA.x2 |
| 321718 | Welded Ring – Steel/Nickel 2GA.x2-1/2 |
| 321720 | Welded Ring – Steel/Nickel 1GA.x3 |
| 321722 | Welded Dee – Steel/Nickel 7/8 |
| 321724 | Welded Dee – Steel/Nickel 1 |
| 321726 | Welded Dee – Steel/Nickel 1-1/4 |
| 321728 | Welded Dee – Steel/Nickel 1-1/2 |
| 996479 | Panel 31 – Welded Rings & Dees |

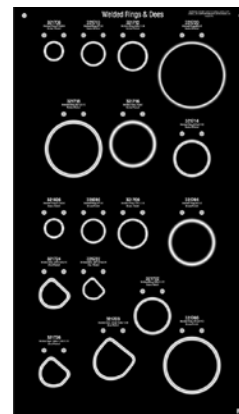

Bolt Snaps & Swivels

Panel 32 – 996480

Total SKUs: 20

| Part # | Description |
|--------|---------------------------------|
| 321420 | Swivel Bolt Snap 3/8 |
| 321422 | Swivel Bolt Snap 1/2 |
| 321424 | Swivel Bolt Snap 5/8 |
| 321426 | Swivel Bolt Snap 3/4 |
| 321428 | Swivel Bolt Snap 1 |
| 321430 | Swivel Bolt Snap 1-3/16 |
| 321432 | Double End Bolt Snap 3-1/2 |
| 321434 | Double End Bolt Snap 4 |
| 321436 | Double End Bolt Snap 4-3/4 |
| 321438 | Strap Rigid Bolt Snap 1 |
| 321440 | Strap Swivel Bolt Snap 1 |
| 321442 | Rigid Bolt Snap 5/8 |
| 321446 | Swivel Trigger Snap 1/2 |
| 321448 | Swivel Trigger Snap 3/4 |
| 321522 | Open Rigid Bolt Snap 3/8 |
| 321524 | Open Rigid Bolt Snap 1/2 |
| 321538 | Double Open Eye Swivel |
| 321540 | Double Round Eye Swivel 5/8 |
| 321542 | Double Strap Eye Swivel 1 |
| 321544 | Double Round Eye Swivel 3/4 |
| 996480 | Panel 32 – Bolt Snaps & Swivels |

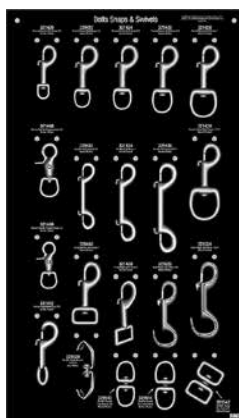

Spring & Animal Snaps

Panel 33 – 996481

Total SKUs: 22

| Part # | Description |
|--------|----------------------------------|
| 321444 | Swivel Quick Snap 3/4 |
| 321450 | Strap Swivel Spring Snap 5/8 |
| 321452 | Strap Swivel Spring Snap 3/4 |
| 321454 | Swivel Spring Snap 1/4 |
| 321456 | Swivel Spring Snap 3/8 |
| 321458 | Swivel Spring Snap 1/2 |
| 321460 | Swivel Spring Snap 3/4 |
| 321462 | Chain Snap 1 & 2 |
| 321464 | Chain Snap 1/0 & 2/0 |
| 321466 | Open Swivel Spring Snap 3/8 |
| 321468 | Strap Rigid Spring Snap 3/4 |
| 321470 | Strap Rigid Spring Snap 1 |
| 321474 | Rope Snap 3/4 |
| 321476 | Swivel Cap Snap 3/4 |
| 321478 | Swivel Cap Snap 1 |
| 321480 | Double End Cap Snap 3-7/8 |
| 321482 | Round Rigid Snap Hook 5/8 |
| 321528 | Swivel Animal Snap 7/8 |
| 321530 | Swivel Animal Snap 1 |
| 321534 | Breeching Snap 2-1/2 |
| 321536 | Bit Snap 1-5/8 |
| 996481 | Panel 33 – Spring & Animal Snaps |

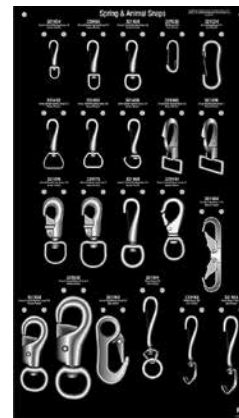

Brass Snaps

Panel 34 – 996482

Total SKUs: 21

| Part # | Description |
|--------|-------------------------------------|
| 321484 | Brass Swivel Bolt Snap 3/8 |
| 321486 | Brass Swivel Bolt Snap 1/2 |
| 321490 | Brass Swivel Bolt Snap 3/4 |
| 321492 | Brass Swivel Bolt Snap 1 |
| 321494 | Brass Swivel Bolt Snap 1-1/4 |
| 321496 | Brass Open Rigid Bolt Snap 3/8 |
| 321498 | Brass Double Bolt Snap 3-3/8 |
| 321500 | Brass Double Bolt Snap 4-1/2 |
| 321502 | Brass Rigid Quick Snap 3/8 |
| 321504 | Brass Rigid Quick Snap 5/8 |
| 321506 | Brass Rigid Quick Snap 11/16 |
| 321508 | Brass Rigid Quick Snap 3/4 |
| 321510 | Brass Swivel Quick Snap 5/8 |
| 321512 | Brass Swivel Quick Snap 11/16 |
| 321514 | Brass Swivel Quick Snap 3/4 |
| 321516 | Brass Trigger Snap 1/2 |
| 852474 | Brass Round Swivel Bolt Snap 13/16 |
| 852476 | Brass Strap Swivel Bolt Snap 1/2 |
| 852478 | Brass Strap Swivel Bolt Snap 1 |
| 852479 | Brass Double Bolt Snap 4-1/8 |
| 852480 | Brass Strap Swivel Trigger Snap 5/8 |
| 996482 | Panel 34 – Solid Brass Snaps |



Awning Pulleys

Panel 35 – 996483

Total SKUs: 16

| Part # | Description |
|--------|---------------------------|
| 321570 | Swivel Eye Single 1/2 |
| 321572 | Swivel Eye Single 3/4 |
| 321574 | Swivel Eye Single 1 |
| 321576 | Swivel Eye Single 1-1/2 |
| 321578 | Swivel Eye Single 2 |
| 321580 | Rigid Eye Single 1/2 |
| 321582 | Rigid Eye Single 3/4 |
| 321584 | Rigid Eye Single 1 |
| 321586 | Rigid Eye Single 1-1/2 |
| 321588 | Rigid Eye Single 2 |
| 321592 | Rigid Eye Double 3/4 |
| 321594 | Rigid Eye Double 1 |
| 321596 | Rigid Eye Double 1-1/2 |
| 321598 | Swivel Eye Double 3/4 |
| 321600 | Swivel Eye Double 1 |
| 321602 | Swivel Eye Double 1-1/2 |
| 996483 | Panel 35 – Awning Pulleys |

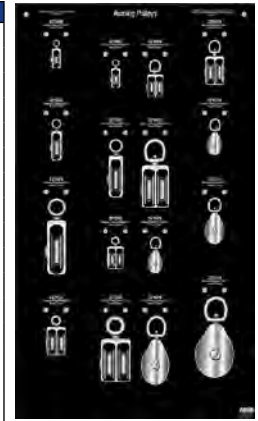

Heavy Duty Pulleys

Panel 36 – 996484

Total SKUs: 11

| Part # | Description |
|--------|---------------------------------------|
| 852488 | Heavy Duty Swivel Single Pulley 1-1/2 |
| 852489 | Heavy Duty Swivel Single Pulley 2 |
| 852490 | Heavy Duty Swivel Single Pulley 3 |
| 852491 | Heavy Duty Rigid Single Pulley 1-1/2 |
| 852492 | Heavy Duty Rigid Single Pulley 2 |
| 852493 | Heavy Duty Rigid Single Pulley 3 |
| 852494 | Heavy Duty Rigid Double Pulley 1-1/2 |
| 852497 | Wall Ceiling Mount Pulley 1-1/2 |
| 852499 | Heavy Duty Pulley Block & Tackle Set |
| 852716 | Heavy Duty Swivel Single Pulley 2-1/2 |
| 852717 | Heavy Duty Rigid Single Pulley 2-1/2 |
| 996484 | Panel 36 – Heavy Duty Pulleys |

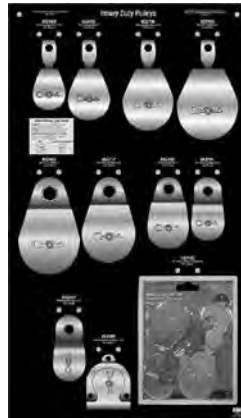

Forged Steel Eye Type Chain Hooks

Panel 37 – 996485

Total SKUs: 8

| Part # | Description |
|--------|-----------------------------------|
| 321970 | Frgd/Zinc Eye Type Grab Hook 1/4 |
| 321972 | Frgd/Zinc Eye Type Grab Hook 5/16 |
| 321974 | Frgd/Zinc Eye Type Grab Hook 3/8 |
| 321976 | Frgd/Zinc Eye Type Grab Hook 1/2 |
| 321978 | Frgd/Zinc Eye Type Slip Hook 1/4 |
| 321980 | Frgd/Zinc Eye Type Slip Hook 5/16 |
| 321982 | Frgd/Zinc Eye Type Slip Hook 3/8 |
| 321984 | Frgd/Zinc Eye Type Slip Hook 1/2 |
| 996485 | Panel 37 – Forged Eye Chain Hooks |



Forged Steel Clevis Type Chain Hooks

Panel 38 – 996486

Total SKUs: 8

| Part # | Description |
|--------|--------------------------------------|
| 321986 | Frgd/Zinc Clevis Type Grab Hook 1/4 |
| 321988 | Frgd/Zinc Clevis Type Grab Hook 5/16 |
| 321990 | Frgd/Zinc Clevis Type Grab Hook 3/8 |
| 321994 | Frgd/Zinc Clevis Type Grab Hook 1/2 |
| 321998 | Frgd/Zinc Clevis Type Slip Hook 1/4 |
| 322000 | Frgd/Zinc Clevis Type Slip Hook 5/16 |
| 322002 | Frgd/Zinc Clevis Type Slip Hook 3/8 |
| 322004 | Frgd/Zinc Clevis Type Slip Hook 1/2 |
| 996486 | Panel 38 – Forged Clevis Chain Hooks |



Chain Hooks with Latch

Panel 39 – 996487

Total SKUs: 9

| Part # | Description |
|--------|--------------------------------------|
| 321482 | Round Eye Rigid Snap Hook 5/8 |
| 321694 | Scissor Hook Steel/Zinc 1/2 |
| 322006 | Forged Hoist Hook 1 Ton |
| 322008 | Forged Hoist Hook 3/4 Ton |
| 322010 | Forged Hoist Hook 1-1/2 Ton |
| 322012 | Forged Hoist Hook 2 Ton |
| 322067 | Forged Clevis Slip Hook w/Latch 1/4 |
| 322068 | Forged Clevis Slip Hook w/Latch 5/16 |
| 322069 | Forged Clevis Slip Hook w/Latch 3/8 |
| 996487 | Panel 39 – Chain Hooks w/Latches |

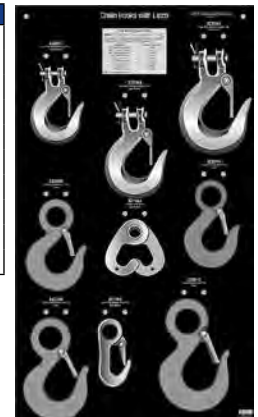

G70 Chain Hooks

Panel 40 – 996488

Total SKUs: 7

| Part # | Description |
|--------|-----------------------------------|
| 322070 | G70 Clevis Grab Hook 3/8 |
| 322071 | G70 Clevis Grab Hook 5/16 |
| 322072 | G70 Clevis Slip Hook 5/16 |
| 322073 | G70 Clevis Slip Hook 3/8 |
| 322074 | G70 Double Clevis Link 1/4 – 5/16 |
| 322075 | G70 Double Clevis Link 3/8 |
| 322076 | G70 Double Clevis Link 1/2 |
| 996488 | Panel 40 – Forged G70 Chain Hooks |

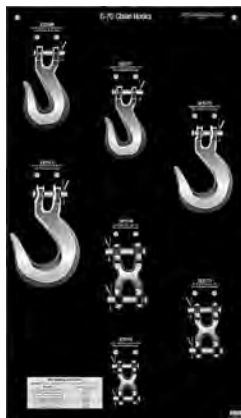

Forged Steel Connection Hardware – Galvanized

Panel 41 – 996489

Total SKUs: 19

| Part # | Description |
|--------|--------------------------------------|
| 322028 | Frgd/Galv Connecting Link 1/4 |
| 322030 | Frgd/Galv Connecting Link 5/16 |
| 322032 | Frgd/Galv Connecting Link 3/8 |
| 322036 | Frgd/Galv Connecting Link 1/2 |
| 322038 | Frgd/Galv Connecting Link 5/8 |
| 322040 | Frgd/Galv Dble. Clevis Link 1/4-5/16 |
| 322042 | Frgd/Galv Dble. Clevis Link 3/8 |
| 322044 | Frgd/Galv Dble. Clevis Link 7/16-1/2 |
| 322046 | Frgd/Galv Dble. Clevis Link 5/8 |
| 322048 | Frgd/Galv Anchor Shackle 3/16 |
| 322050 | Frgd/Galv Anchor Shackle 1/4 |
| 322052 | Frgd/Galv Anchor Shackle 5/16 |
| 322054 | Frgd/Galv Anchor Shackle 3/8 |
| 322056 | Frgd/Galv Anchor Shackle 7/16 |
| 322058 | Frgd/Galv Anchor Shackle 1/2 |
| 852451 | Frgd/Galv Swivel 3/16 |
| 852452 | Frgd/Galv Swivel 1/4 |
| 852453 | Frgd/Galv Swivel 5/16 |
| 852454 | Frgd/Galv Swivel 3/8 |
| 996489 | Panel 41–Forg/Galv Connection Hdwe |

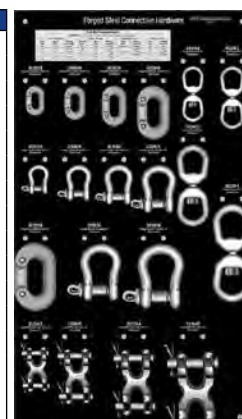

Links & Cold Shuts

Panel 42 – 996490

Total SKUs: 23

| Part # | Description |
|--------|-------------------------------------|
| 321650 | Safety Spring Snap Link 1/4 |
| 321652 | Safety Spring Snap Link 5/16 |
| 321654 | Safety Spring Snap Link 3/8 |
| 321656 | Safety Spring Snap Link 7/16 |
| 321658 | Safety Spring Snap Link 1/2 |
| 321660 | Safety Spring Snap Link 5/8 |
| 321666 | Quick Link 1/8 |
| 321670 | Quick Link 3/16 |
| 321672 | Quick Link 1/4 |
| 321674 | Quick Link 5/16 |
| 321676 | Quick Link 3/8 |
| 321678 | Quick Link 1/2 |
| 321680 | Quick Link 9/16 |
| 321682 | Lap Link 1/8 |
| 321684 | Lap Link 3/16 |
| 321686 | Lap Link 1/4 |
| 321688 | Lap Link 5/16 |
| 321690 | Lap Link 3/8 |
| 322014 | Cold Shut 3/16-1/8 Chain |
| 322016 | Cold Shut 1/4-3/16 Chain |
| 322018 | Cold Shut 5/16-1/4 Chain |
| 322020 | Cold Shut 3/8-5/16 Chain |
| 322022 | Cold Shut 7/16-3/8 Chain |
| 996490 | Panel 42 – Chain Links & Cold Shuts |

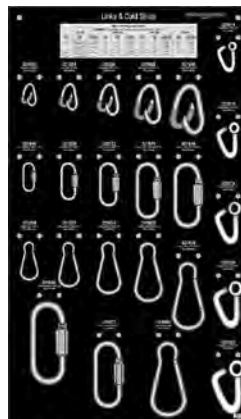

Rope Loops, Cleats, Clamps & Hooks

Panel 43 – 996491

Total SKUs: 22

| Part # | Description |
|--------|---|
| 322300 | Rope Cleat – Brass 2-7/16 |
| 322302 | Rope Cleat – Brass 3-3/4 |
| 322304 | Rope Cleat – Brass 4-3/8 |
| 322306 | Rope Cleat – Brass 5-3/8 |
| 322308 | Rope Cleat – Zinc Die Cast/Nickel 2-1/2 |
| 322310 | Rope Cleat – Zinc Die Cast/Nickel 4-1/2 |
| 322312 | Rope Cleat – Zinc Die Cast/Nickel 6 |
| 322316 | Tarp Rope Hook Steel/Zinc .212 |
| 322318 | Tarp Rope Hook Steel/Zinc .306 |
| 322320 | Tarp Rope Hook Steel/Zinc .362 |
| 322322 | Tarp Rope Hook Steel/Zinc .444 |
| 852022 | Tarp Rope Hook Knob End |
| 322324 | Easy Knot Rope Tie Hook Steel/Zinc |
| 852023 | Strap Loop Nickel Plated 1 |
| 852712 | Strap Loop Nickel Plated 1-1/4 |
| 852713 | Strap Loop Nickel Plated 1-1/2 |
| 852024 | Strap Loop Nickel Plated 2 |
| 852025 | Rope Loop Nickel Plated 1/2 |
| 322314 | Rope Tie Strap Steel/Zinc 3/8x2-1/4 |
| 852485 | Rope Clamp .25-.37 |
| 852486 | Rope Clamp .37-.50 |
| 852487 | Brass Rope Clamp .43-.50 |
| 996491 | Panel 43–Rope Clts-Clamps-Hks-Loops |



Rope Accessories

Panel 44 – 996492

Total SKUs: 10

| Part # | Description |
|--------|-----------------------------------|
| 322326 | Clothesline Hook Plate Style |
| 322328 | Rope Binding Hook – Locking |
| 322330 | Rope Binding Hook – Snap Back |
| 322332 | Hammock Hook – Plate Style |
| 322334 | Hammock Hook – Lag Style |
| 322336 | Hitching Ring – Plate Style |
| 322338 | Hitching Ring – Machine Style 4" |
| 322340 | Hitching Ring – Machine Style 6" |
| 322342 | Hitching Ring – Lag Style 2" I.D. |
| 322344 | Hitching Ring – Lag Style 3" I.D. |
| 996492 | Panel 44 – Rope Accessories |



Stainless Steel Links & Snaps

Panel 48 – 996496

Total SKUs: 14

| Part # | Description |
|--------|---------------------------------|
| 852026 | Stainless Steel Snap Link 5/16 |
| 852027 | Stainless Steel Snap Link 7/16 |
| 852028 | Stainless Steel Snap Link 5/8 |
| 852029 | Stainless Steel Snap Link 3/4 |
| 852030 | Stainless Steel Quick Link 1/8 |
| 852031 | Stainless Steel Quick Link 3/16 |
| 852032 | Stainless Steel Quick Link 1/4 |
| 852033 | Stainless Steel Quick Link 5/16 |
| 852034 | Stainless Steel Quick Link 3/8 |
| 852465 | SS Swivel Bolt Snap 1/2 |
| 852466 | SS Swivel Bolt Snap 3/4 |
| 852467 | SS Double Bolt Snap 4 |
| 852469 | SS Rigid Quick Snap 3/4 |
| 852473 | SS Rigid Spring Hook 1-1/8 |
| 996496 | Panel 48 – SS Links & Snaps |



Snaps

SMALL

Panel 49 – 996497

Total SKUs: 20

| Part # | Description |
|--------|------------------------------|
| 321420 | Swivel Bolt Snap 3/8 |
| 321422 | Swivel Bolt Snap 1/2 |
| 321424 | Swivel Bolt Snap 5/8 |
| 321426 | Swivel Bolt Snap 3/4 |
| 321430 | Swivel Bolt Snap 1-3/16 |
| 321432 | Double End Bolt Snap 3-1/2 |
| 321434 | Double End Bolt Snap 4 |
| 321436 | Double End Bolt Snap 4-3/4 |
| 321440 | Strap Swivel Bolt Snap 1 |
| 321442 | Rigid Bolt Snap 5/8 |
| 321444 | Swivel Quick Snap 3/4 |
| 321446 | Swivel Trigger Snap 1/2 |
| 321448 | Swivel Trigger Snap 3/4 |
| 321454 | Round Swivel Spring Snap 1/4 |
| 321468 | Strap Rigid Spring Snap 3/4 |
| 321478 | Swivel Cap Snap 1 |
| 321528 | Swivel Animal Snap 7/8 |
| 321530 | Swivel Animal Snap 1 |
| 321534 | Breeching Snap 2-1/2 |
| 321536 | Bit Snap 1-5/8 |
| 996497 | Panel 49 – Snaps Combination |



Lock Pins – Square, Round & Spring

Panel 59 – 996506

Total SKUs: 21

| Part # | Description |
|--------|--|
| 883838 | 1/4 x 1-3/4 Round Lock Pin |
| 882693 | 1/4 x 2 Round Lock Pin |
| 883839 | 5/16 x 1-3/4 Round Lock Pin |
| 882694 | 5/16 x 2-3/4 Round Lock Pin |
| 883840 | 3/8 x 1-3/4 Round Lock Pin |
| 882695 | 5/16 x 2-3/4 Square |
| 882696 | 3/8 x 2-1/2 Square Lock Pin |
| 882697 | 3/8 x 2-3/4 Square Lock Pin |
| 967114 | 1/4 x 2-1/8 Spring Lock Pin |
| 967113 | 5/16 x 2-1/4 Spring Lock Pin |
| 967112 | 3/8 x 2-3/8 Spring Lock Pin |
| 967111 | 1/2 x 4-1/2 Spring Lock Pin |
| 967110 | 5/8 x 4-1/8 Spring Lock Pin |
| 881128 | 3/16" Linch Pin - Zinc & Yellow |
| 881129 | 1/4" Linch Pin - Zinc & Yellow |
| 881130 | 5/16" Linch Pin - Zinc & Yellow |
| 881131 | 7/16" Linch Pin - Zinc & Yellow |
| 883507 | 7/16" 5pk Linch Pin - Zinc & Yellow |
| 883508 | 7/16" 10pk Linch Pin - Zinc & Yellow |
| 883509 | 7/16" Heavy Duty Linch Pin - Zinc & Yellow |
| 883510 | 7/16" w/chain Linch Pin - Zinc & Yellow |
| 996506 | Panel 59 - Lock Pins Sq, Rd, Spring |



Hitch Pins – Zinc & Yellow Part 1

Panel 55 – 996502

Total SKUs: 6

| Part # | Description |
|--------|---------------------------------------|
| 881133 | Hitch Pin - Zinc & Yellow 1/2 x 4 |
| 967105 | Hitch Pin - Zinc & Yellow 5/8 x 6 |
| 881134 | Hitch Pin - Zinc & Yellow 5/8 x 6-1/4 |
| 967106 | Hitch Pin - Zinc & Yellow 3/4 x 4-1/4 |
| 881135 | Hitch Pin - Zinc & Yellow 3/4 x 6-1/4 |
| 967107 | Hitch Pin - Zinc & Yellow 3/4 x 6-1/4 |
| 996502 | Panel 55 – Hitch Pins Z & Y |



Hitch Pins – Zinc & Yellow Part 2

Panel 56 – 996503

Total SKUs: 7

| Part # | Description |
|--------|-----------------------------------|
| 967108 | Hitch Pin-Z & Y 7/8x6-1/4 |
| 967109 | Hitch Pin-Z & Y 1x6-3/4 |
| 883841 | Hitch Pin-Z & Y 3/8x4 Bent w/clip |
| 883842 | Hitch Pin-Z & Y 1/2x3 Bent w/clip |
| 883843 | Hitch Pin-Z & Y 1/2x4 Bent w/clip |
| 881132 | Hitch Pin-Z & Y 5/8x3 Bent w/clip |
| 967099 | Hitch Pin-Z & Y 5/8x4 Bent w/clip |
| 996503 | Panel 56 – Hitch Pins Z & Y Part2 |



Rubber Handled Hitch Pins – Part 1

Panel 57 – 996504

Total SKUs: 6

| Part # | Description |
|--------|----------------------------------|
| 881136 | Rubber Handle 1/2 x 3-5/8 |
| 883831 | Rubber Handle 5/8 x 4 |
| 967101 | Rubber Handle 3/4 x 4 |
| 967102 | Rubber Handle 3/4 x 6-1/2 |
| 883836 | Rubber Handle 1-1/4 x 8-1/2 |
| 883837 | Rubber Handle 1-1/2 x 8-1/2 |
| 996504 | Panel 57 – Hitch Pins Rub Handle |



Rubber Handled Hitch Pins – Part 2

Panel 58 – 996505

Total SKUs: 6

| Part # | Description |
|--------|---------------------------------------|
| 967100 | Rubber Handle 5/8 x 5-3/4 |
| 883832 | Rubber Handle 7/8 x 4-1/4 |
| 967103 | Rubber Handle 7/8 x 6-1/2 |
| 883833 | Rubber Handle 1 x 4-3/4 |
| 883834 | Rubber Handle 1 x 7-1/2 |
| 883835 | Rubber Handle 1-1/8 x 8-1/2 |
| 996505 | Panel 58 – Hitch Pins Rub Handle Pt 2 |



Shaft Collars & Machinery Bushings

Panel 60 – 996507

Total SKUs: 33

| Part # | Description |
|--------|---|
| 883551 | 1/8 x 11/32 x 1/4 |
| 883552 | 3/16 x 7/16 x 1/4 Shaft Collars |
| 838617 | 1/4 x 1/2 x 9/32 Shaft Collars |
| 883553 | 5/16 x 5/8 x 5/16 Shaft Collars |
| 838618 | 3/8 x 3/4 x 3/8 Shaft Collars |
| 838619 | 7/16 x 7/8 x 7/16 Shaft Collars |
| 838620 | 1/2 x 1 x 7/16 Shaft Collars |
| 883554 | 9/16 x 1 x 7/16 Shaft Collars |
| 838621 | 5/8 x 11/8 x 1/2 Shaft Collars |
| 838622 | 3/4 x 1-1/4 x 9/16 Shaft Collars |
| 883555 | 7/8 x 1-1/2 x 9/16 Shaft Collars |
| 883556 | 1 x 1-5/8 x 5/8 Shaft Collars |
| 883557 | 1/8" Double Split Shaft Collars |
| 883558 | 3/16" Double Split Shaft Collars |
| 883559 | 1/4" Double Split Shaft Collars |
| 883560 | 5/16" Double Split Shaft Collars |
| 883561 | 3/8" Double Split Shaft Collars |
| 883562 | 7/16" Double Split Shaft Collars |
| 883563 | 1/2" Double Split Shaft Collars |
| 883564 | 9/16" Double Split Shaft Collars |
| 883565 | 5/8" Double Split Shaft Collars |
| 883566 | 3/4" Double Split Shaft Collars |
| 883567 | 7/8" Double Split Shaft Collars |
| 883568 | 1" Double Split Shaft Collars |
| 883574 | 1/2 x 7/8 x 18Ga Machinery Bushings |
| 883575 | 9/16 x 1 x 18Ga Machinery Bushings |
| 882801 | 5/8 x 1 x 18Ga Machinery Bushings |
| 882394 | 3/4 x 1-1/4 x 18Ga Machinery Bushings |
| 882396 | 7/8 x 1-3/8 x 18Ga Machinery Bushings |
| 882397 | 1 x 1-1/2 x 18Ga Machinery Bushings |
| 883576 | 1-1/8 x 1-3/4 x 18Ga Machinery Bushings |
| 883577 | 1-1/4 x 1-7/8 x 18Ga Machinery Bushings |
| 883578 | 1-3/8 x 2-1/8 x 18Ga Machinery Bushings |
| 996507 | Panel 60 – Shaft Collars & Mach. Bush |

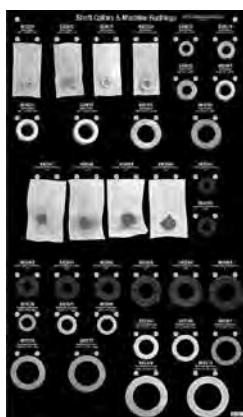

Metric Shaft Collars & Hitch Pin Clips

Panel 61 – 996508

Total SKUs: 35

| Part # | Description |
|--------|--|
| 883693 | M6 Metric Shaft Collars |
| 883694 | M8 Metric Shaft Collars |
| 883695 | M10 Metric Shaft Collars |
| 883696 | M12 Metric Shaft Collars |
| 883697 | M14 Metric Shaft Collars |
| 883698 | M16 Metric Shaft Collars |
| 883699 | M18 Metric Shaft Collars |
| 883700 | M20 Metric Shaft Collars |
| 883701 | M25 Metric Shaft Collars |
| 883702 | M6 Metric Double Split Shaft Collars |
| 883703 | M8 Metric Double Split Shaft Collars |
| 883704 | M10 Metric Double Split Shaft Collars |
| 883705 | M12 Metric Double Split Shaft Collars |
| 883706 | M14 Metric Double Split Shaft Collars |
| 883707 | M16 Metric Double Split Shaft Collars |
| 883708 | M18 Metric Double Split Shaft Collars |
| 883709 | M20 Metric Double Split Shaft Collars |
| 883710 | M25 Metric Double Split Shaft Collars |
| 881095 | .062 x 1-5/16 Hitch Pin Clips |
| 881096 | .093 x 1-5/8 Hitch Pin Clips |
| 881097 | .093 x 2-5/16 Hitch Pin Clips |
| 882592 | .093 x 2-1/2 Hitch Pin Clips |
| 882593 | .125 x 2-9/16 Hitch Pin Clips |
| 881099 | .125 x 1-15/16 Hitch Pin Clips |
| 881098 | .125 x 2-1/2 Hitch Pin Clips |
| 881100 | .148 x 2-15/16 Hitch Pin Clips |
| 881102 | .177 x 3-1/4 Hitch Pin Clips |
| 881101 | .177 x 3-3/4 Hitch Pin Clips |
| 882594 | .243 x 4 Hitch Pin Clips |
| 881122 | 1/4 x 1-1/4 Cotterless Hitch Pins |
| 881123 | 1/4 x 1-3/4 Cotterless Hitch Pins |
| 881124 | 1/4 x 3 Cotterless Hitch Pins |
| 881125 | 3/8 x 1-1/8 Cotterless Hitch Pins |
| 881126 | 3/8 x 1-5/8 Cotterless Hitch Pins |
| 881127 | 3/8 x 2-1/8 Cotterless Hitch Pins |
| 996508 | Panel 61 – Metric Shaft Col & Hitch Pins |



Blank Black Panel

Panel 50 – 996499

| Part # | Description |
|--------|--------------------------------------|
| 996498 | Panel 50 – Blank 12" x 21" Blk Panel |

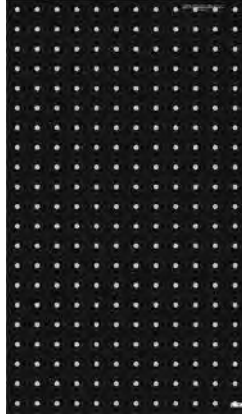

Blank Grey Panel

Panel 51 – 996501

| Part # | Description |
|--------|-------------------------------------|
| 996499 | Panel 51–Blank 12" x 21" Grey Panel |

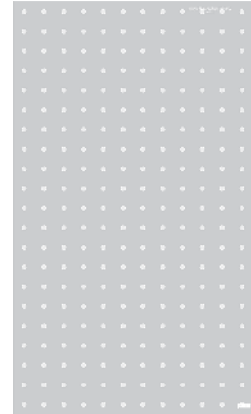

NOTES

Area for handwritten notes, consisting of multiple horizontal lines.

AN INTRODUCTION TO...

COMMERCIAL LETTERS, NUMBERS & SIGNS

LETTRES, CHIFFRES & AFFICHES COMMERCIAUX

...UNE INTRODUCTION.

www.hpaulin.com

For a full listing of Paulin®
Commercial Letters / Numbers /
Signs, please refer to our current
catalogue or visit our website to
download a PDF version.



**COMMERCIAL LETTERS,
NUMBERS & SIGNS**

**SELF ADHESIVE LETTERS &
NUMBERS REUSEABLE STENCILS**

SIGN PROGRAM

**SPECIALTY/NOVELTY SIGNS
& ACCESSORIES**



**COMMERCIAL LETTERS, NUMBERS & SIGNS
LETTRES, CHIFFRES ET AFFICHES COMMERCIAUX**

COMMERCIAL OPTIMIZER

No. 022-107

The perfect start to a Letters, Numbers and Signs Department. Utilizing just 4 feet of display area, space is “Optimized” by the use of one 3-sided merchandising tower and a cascading waterfall rack. The assortment offers coverage in fourteen different product categories.



COMMERCIAL LETTERS, NUMBERS & SIGNS MERCHANDISER PRÉSENTOIR LETTRES, CHIFFRES ET AFFICHES COMMERCIAUX

No. 022-107

| Item Number | Size | Description | Pkg Qty | Qty Per Pack | Case Qty |
|-------------|------|-----------------------|---------|--------------|----------|
| 839560 | 3" | DIE-CUT BLACK VINYL A | 1 | 6 | 1200 |
| 839562 | 3" | DIE-CUT BLACK VINYL B | 1 | 6 | 1200 |
| 839564 | 3" | DIE-CUT BLACK VINYL C | 1 | 6 | 1200 |
| 839566 | 3" | DIE-CUT BLACK VINYL D | 1 | 6 | 1200 |
| 839568 | 3" | DIE-CUT BLACK VINYL E | 1 | 6 | 1200 |
| 839570 | 3" | DIE-CUT BLACK VINYL F | 1 | 6 | 1200 |
| 839572 | 3" | DIE-CUT BLACK VINYL G | 1 | 6 | 1200 |
| 839574 | 3" | DIE-CUT BLACK VINYL H | 1 | 6 | 1200 |
| 839576 | 3" | DIE-CUT BLACK VINYL I | 1 | 6 | 1200 |
| 839578 | 3" | DIE-CUT BLACK VINYL J | 1 | 6 | 1200 |
| 839580 | 3" | DIE-CUT BLACK VINYL K | 1 | 6 | 1200 |
| 839582 | 3" | DIE-CUT BLACK VINYL L | 1 | 6 | 1200 |
| 839584 | 3" | DIE-CUT BLACK VINYL M | 1 | 6 | 1200 |
| 839586 | 3" | DIE-CUT BLACK VINYL N | 1 | 6 | 1200 |
| 839588 | 3" | DIE-CUT BLACK VINYL O | 1 | 6 | 1200 |
| 839590 | 3" | DIE-CUT BLACK VINYL P | 1 | 6 | 1200 |
| 839592 | 3" | DIE-CUT BLACK VINYL Q | 1 | 6 | 1200 |
| 839594 | 3" | DIE-CUT BLACK VINYL R | 1 | 6 | 1200 |
| 839596 | 3" | DIE-CUT BLACK VINYL S | 1 | 6 | 1200 |
| 839598 | 3" | DIE-CUT BLACK VINYL T | 1 | 6 | 1200 |
| 839600 | 3" | DIE-CUT BLACK VINYL U | 1 | 6 | 1200 |
| 839602 | 3" | DIE-CUT BLACK VINYL V | 1 | 6 | 1200 |
| 839604 | 3" | DIE-CUT BLACK VINYL W | 1 | 6 | 1200 |
| 839606 | 3" | DIE-CUT BLACK VINYL X | 1 | 6 | 1200 |
| 839608 | 3" | DIE-CUT BLACK VINYL Y | 1 | 6 | 1200 |
| 839610 | 3" | DIE-CUT BLACK VINYL Z | 1 | 6 | 1200 |
| 839612 | 3" | DIE-CUT BLACK VINYL 1 | 1 | 6 | 1200 |
| 839614 | 3" | DIE-CUT BLACK VINYL 2 | 1 | 6 | 1200 |
| 839616 | 3" | DIE-CUT BLACK VINYL 3 | 1 | 6 | 1200 |
| 839618 | 3" | DIE-CUT BLACK VINYL 4 | 1 | 6 | 1200 |
| 839620 | 3" | DIE-CUT BLACK VINYL 5 | 1 | 6 | 1200 |
| 839622 | 3" | DIE-CUT BLACK VINYL 6 | 1 | 6 | 1200 |
| 839624 | 3" | DIE-CUT BLACK VINYL 7 | 1 | 6 | 1200 |
| 839626 | 3" | DIE-CUT BLACK VINYL 8 | 1 | 6 | 1200 |
| 839628 | 3" | DIE-CUT BLACK VINYL 9 | 1 | 6 | 1200 |
| 839630 | 3" | DIE-CUT BLACK VINYL 0 | 1 | 6 | 1200 |
| 839632 | 3" | WHITE DIE CUT VINYL A | 1 | 6 | 1200 |
| 839634 | 3" | WHITE DIE CUT VINYL B | 1 | 6 | 1200 |
| 839636 | 3" | WHITE DIE CUT VINYL C | 1 | 6 | 1200 |
| 839638 | 3" | WHITE DIE CUT VINYL D | 1 | 6 | 1200 |
| 839640 | 3" | WHITE DIE CUT VINYL E | 1 | 6 | 1200 |
| 839642 | 3" | WHITE DIE CUT VINYL F | 1 | 6 | 1200 |
| 839644 | 3" | WHITE DIE CUT VINYL G | 1 | 6 | 1200 |
| 839646 | 3" | WHITE DIE CUT VINYL H | 1 | 6 | 1200 |
| 839648 | 3" | WHITE DIE CUT VINYL I | 1 | 6 | 1200 |
| 839650 | 3" | WHITE DIE CUT VINYL J | 1 | 6 | 1200 |
| 839652 | 3" | WHITE DIE CUT VINYL K | 1 | 6 | 1200 |
| 839654 | 3" | WHITE DIE CUT VINYL L | 1 | 6 | 1200 |
| 839656 | 3" | WHITE DIE CUT VINYL M | 1 | 6 | 1200 |
| 839658 | 3" | WHITE DIE CUT VINYL N | 1 | 6 | 1200 |
| 839660 | 3" | WHITE DIE CUT VINYL O | 1 | 6 | 1200 |
| 839662 | 3" | WHITE DIE CUT VINYL P | 1 | 6 | 1200 |

| Item Number | Size | Description | Pkg Qty | Qty Per Pack | Case Qty |
|-------------|----------|--------------------------|---------|--------------|----------|
| 839664 | 3" | WHITE DIE CUT VINYL Q | 1 | 6 | 1200 |
| 839666 | 3" | WHITE DIE CUT VINYL R | 1 | 6 | 1200 |
| 839668 | 3" | WHITE DIE CUT VINYL S | 1 | 6 | 1200 |
| 839670 | 3" | WHITE DIE CUT VINYL T | 1 | 6 | 1200 |
| 839672 | 3" | WHITE DIE CUT VINYL U | 1 | 6 | 1200 |
| 839674 | 3" | WHITE DIE CUT VINYL V | 1 | 6 | 1200 |
| 839676 | 3" | WHITE DIE CUT VINYL W | 1 | 6 | 1200 |
| 839678 | 3" | WHITE DIE CUT VINYL X | 1 | 6 | 1200 |
| 839680 | 3" | WHITE DIE CUT VINYL Y | 1 | 6 | 1200 |
| 839682 | 3" | WHITE DIE CUT VINYL Z | 1 | 6 | 1200 |
| 839684 | 3" | WHITE DIE CUT VINYL 1 | 1 | 6 | 1200 |
| 839686 | 3" | WHITE DIE CUT VINYL 2 | 1 | 6 | 1200 |
| 839688 | 3" | WHITE DIE CUT VINYL 3 | 1 | 6 | 1200 |
| 839690 | 3" | WHITE DIE CUT VINYL 4 | 1 | 6 | 1200 |
| 839692 | 3" | WHITE DIE CUT VINYL 5 | 1 | 6 | 1200 |
| 839694 | 3" | WHITE DIE CUT VINYL 6 | 1 | 6 | 1200 |
| 839696 | 3" | WHITE DIE CUT VINYL 7 | 1 | 6 | 1200 |
| 839698 | 3" | WHITE DIE CUT VINYL 8 | 1 | 6 | 1200 |
| 839700 | 3" | WHITE DIE CUT VINYL 9 | 1 | 6 | 1200 |
| 839702 | 3" | WHITE DIE CUT VINYL 0 | 1 | 6 | 1200 |
| 839712 | 3" | G&B LETR ST-54 PC | 1 | 5 | 60 |
| 839726 | 4" | PKGD STENCILS SET | 1 | 5 | 30 |
| 839728 | 6" | PKGD STENCILS SET | 1 | 5 | 30 |
| 839810 | 2" x 8" | MYL-ARROW | 1 | 6 | 330 |
| 839812 | 2" x 8" | MYL-ENTRANCE | 1 | 6 | 330 |
| 839814 | 2" x 8" | LADIES NICKEL BLACK/BLUE | 1 | 6 | 330 |
| 839816 | 2" x 8" | MEN NICKEL BLACK/BLUE | 1 | 6 | 330 |
| 839818 | 2" x 8" | MYL-KP DOOR CLSD | 1 | 6 | 330 |
| 839824 | 2" x 8" | MYL-PUSH | 1 | 6 | 330 |
| 839828 | 2" x 8" | MYL-PULL | 1 | 6 | 330 |
| 839830 | 2" x 8" | MYL-BEWARE DOG | 1 | 6 | 330 |
| 839832 | 2" x 8" | MYL-EMPLOYEE ONLY | 1 | 6 | 330 |
| 839834 | 2" x 8" | MYL-EXIT | 1 | 6 | 330 |
| 839836 | 2" x 8" | MYL-NO ADMITTNCE | 1 | 6 | 330 |
| 839838 | 2" x 8" | MYL-NO SMOKING | 1 | 6 | 330 |
| 839840 | 2" x 8" | MYL-NO SOLICITNG | 1 | 6 | 330 |
| 839888 | 8" x 12" | PLS-R/B BUSINESS HR | 1 | 6 | 450 |
| 839892 | 8" x 12" | PLS-R/B EXIT | 1 | 6 | 450 |
| 839894 | 8" x 12" | PLS-R/B HELP WANTED | 1 | 6 | 450 |
| 839896 | 8" x 12" | PLS-R/B NO SMOKING | 1 | 6 | 450 |
| 839898 | 8" x 12" | PLS-R/B KEEP OUT | 1 | 6 | 450 |
| 839900 | 8" x 12" | PLS-R/B NO DUMPING | 1 | 6 | 450 |
| 839902 | 8" x 12" | PLS-R/B NO PARKING | 1 | 6 | 450 |
| 839904 | 8" x 12" | PLS-R/B NO TRESPASS | 1 | 6 | 450 |
| 839906 | 8" x 12" | PLS-R/B PRVT KP OUT | 1 | 6 | 450 |
| 839908 | 8" x 12" | PLS-R/B PRVT PRPRT | 1 | 6 | 450 |
| 839916 | 8" x 12" | PLS-R/B OPEN/CLOSED | 1 | 6 | 450 |
| 839974 | 8" x 12" | PLS-R/B-DG HARD HAT | 1 | 6 | 450 |
| 839976 | 8" x 12" | PLS-R/B-DG RESTRICT | 1 | 6 | 450 |
| 839978 | 8" x 12" | PLS-R/B-DG HI VOLTG | 1 | 6 | 450 |
| 839980 | 8" x 12" | PLS-B/Y-CN DO NT EN | 1 | 6 | 450 |
| 839982 | 8" x 12" | PLS-B/Y-CN EY PRCTCT | 1 | 6 | 450 |

COMMERCIAL LETTERS, NUMBERS & SIGNS MERCHANDISER PRÉSENTOIR LETTRES, CHIFFRES ET AFFICHES COMMERCIAUX

No. 022-107 - CONTINUED...

| Item Number | Size | Description | Pkg Qty | Qty Per Pack | Case Qty |
|-------------|-----------|---------------------------|---------|--------------|----------|
| 839984 | 8" x 12" | PLS-B/Y-CN HAZ MTRL | 1 | 6 | 450 |
| 839986 | 8" x 12" | PLS-R/B-DG PROPANE | 1 | 6 | 450 |
| 839989 | 8" x 12" | PLS-B/Y-CN FALL ICE | 1 | 6 | 450 |
| 840014 | 18" x 12" | PLS-R/B-NO PARKING | 1 | 5 | 60 |
| 840016 | 18" x 12" | PLS-G/W-VIST PRKNG | 1 | 5 | 60 |
| 840022 | 18" x 12" | PLS-BU/W-HNDPCP PRK | 1 | 5 | 60 |
| 840040 | 15" x 19" | PLS-R/B NO TRESPAS | 1 | 6 | 120 |
| 840042 | 15" x 19" | PLS-R/B-KEEP OUT | 1 | 6 | 120 |
| 840046 | 15" x 19" | PLS-R/B-OPEN/CLOSED | 1 | 6 | 120 |
| 840068 | 36" | DRIVEWY MRKR-BLU | 1 | 24 | 24 |
| 840070 | 36" | DRIVEWY MRKR-RED | 1 | 24 | 24 |
| 840203 | 4x10 | GID FIRE EX-RHT-ARW | 1 | 10 | 300 |
| 840370 | | TAPE-REFLECT SAFETY STRIP | 1 | 6 | 144 |
| 840378 | 24x2 | REFL TAPE BLK/YELLW | 1 | 5 | 35 |
| 840380 | 24x2 | REFL TAPE RED/SILVR | 1 | 5 | 45 |
| 840382 | 24x2 | REFL TAPE SOL.SLVR | 1 | 5 | 45 |
| 840384 | 24x2 | REFL TAPE SOLID RED | 1 | 5 | 35 |
| 840474 | 1-1/2" | ALU-A/C-BLK/GLD-#0 | 1 | 6 | 1500 |
| 840476 | 1-1/2" | ALU-A/C-BLK/GLD-#1 | 1 | 6 | 1500 |
| 840478 | 1-1/2" | ALU-A/C-BLK/GLD-#2 | 1 | 6 | 1500 |
| 840480 | 1-1/2" | ALU-A/C-BLK/GLD-#3 | 1 | 6 | 1500 |
| 840482 | 1-1/2" | ALU-A/C-BLK/GLD-#4 | 1 | 6 | 1500 |
| 840484 | 1-1/2" | ALU-A/C-BLK/GLD-#5 | 1 | 6 | 1500 |
| 840486 | 1-1/2" | ALU-A/C-BLK/GLD-#6 | 1 | 6 | 1500 |
| 840488 | 1-1/2" | ALU-A/C-BLK/GLD-#7 | 1 | 6 | 1500 |
| 840490 | 1-1/2" | ALU-A/C-BLK/GLD-#8 | 1 | 6 | 1500 |
| 840492 | 1-1/2" | ALU-A/C-BLK/GLD-#9 | 1 | 6 | 1500 |
| 840494 | 1-1/2" | ALU-A/C-BLK/GLD-A | 1 | 6 | 1500 |
| 840496 | 1-1/2" | ALU-A/C-BLK/GLD-B | 1 | 6 | 1500 |
| 840498 | 1-1/2" | ALU-A/C-BLK/GLD-C | 1 | 6 | 1500 |
| 840500 | 1-1/2" | ALU-A/C-BLK/GLD-D | 1 | 6 | 1500 |
| 840502 | 1-1/2" | ALU-A/C-BLK/GLD-E | 1 | 6 | 1500 |
| 840504 | 1-1/2" | ALU-A/C-BLK/GLD-F | 1 | 6 | 1500 |
| 840506 | 1-1/2" | ALU-A/C-BLK/GLD-G | 1 | 6 | 1500 |
| 840508 | 1-1/2" | ALU-A/C-BLK/GLD-H | 1 | 6 | 1500 |
| 840510 | 1-1/2" | ALU-A/C-BLK/GLD-I | 1 | 6 | 1500 |
| 840512 | 1-1/2" | ALU-A/C-BLK/GLD-J | 1 | 6 | 1500 |
| 840514 | 1-1/2" | ALU-A/C-BLK/GLD-K | 1 | 6 | 1500 |
| 840516 | 1-1/2" | ALU-A/C-BLK/GLD-L | 1 | 6 | 1500 |
| 840518 | 1-1/2" | ALU-A/C-BLK/GLD-M | 1 | 6 | 1500 |
| 840520 | 1-1/2" | ALU-A/C-BLK/GLD-N | 1 | 6 | 1500 |
| 840522 | 1-1/2" | ALU-A/C-BLK/GLD-O | 1 | 6 | 1500 |
| 840524 | 1-1/2" | ALU-A/C-BLK/GLD-P | 1 | 6 | 1500 |
| 840526 | 1-1/2" | ALU-A/C-BLK/GLD-Q | 1 | 6 | 1500 |
| 840528 | 1-1/2" | ALU-A/C-BLK/GLD-R | 1 | 6 | 1500 |
| 840530 | 1-1/2" | ALU-A/C-BLK/GLD-S | 1 | 6 | 1500 |
| 840532 | 1-1/2" | ALU-A/C-BLK/GLD-T | 1 | 6 | 1500 |
| 840534 | 1-1/2" | ALU-A/C-BLK/GLD-U | 1 | 6 | 1500 |
| 840536 | 1-1/2" | ALU-A/C-BLK/GLD-V | 1 | 6 | 1500 |
| 840538 | 1-1/2" | ALU-A/C-BLK/GLD-W | 1 | 6 | 1500 |
| 840540 | 1-1/2" | ALU-A/C-BLK/GLD-X | 1 | 6 | 1500 |
| 840542 | 1-1/2" | ALU-A/C-BLK/GLD-Y | 1 | 6 | 1500 |

| Item Number | Size | Description | Pkg Qty | Qty Per Pack | Case Qty |
|-------------|-----------|-------------------------------|---------|--------------|----------|
| 840544 | 1-1/2" | ALU-A/C-BLK/GLD-Z | 1 | 6 | 1500 |
| 840546 | 1-1/2" | ALU-A/C-BLK/GLD-SP | 1 | 6 | 1500 |
| 840548 | 1-1/2" | ALU-A/C-BLK/GLD-HY | 1 | 6 | 1500 |
| 840550 | 1-1/2" | ALU-A/C-BLK/GLD-AM | 1 | 6 | 1500 |
| 840552 | 3" | ANGLE CUT ALUM. #0 | 1 | 3 | 750 |
| 840554 | 3" | ANGLE CUT ALUM. #1 | 1 | 3 | 750 |
| 840556 | 3" | ANGLE CUT ALUM. #2 | 1 | 3 | 750 |
| 840558 | 3" | ANGLE CUT ALUM. #3 | 1 | 3 | 750 |
| 840560 | 3" | ANGLE CUT ALUM. #4 | 1 | 3 | 750 |
| 840562 | 3" | ANGLE CUT ALUM. #5 | 1 | 3 | 750 |
| 840564 | 3" | ANGLE CUT ALUM. #6 | 1 | 3 | 750 |
| 840566 | 3" | ANGLE CUT ALUM. #7 | 1 | 3 | 750 |
| 840568 | 3" | ANGLE CUT ALUM. #8 | 1 | 3 | 750 |
| 840570 | 3" | ANGLE CUT ALUM. #9 | 1 | 3 | 750 |
| 840628 | | SLOW MOVING VECH.SIGN | 1 | 6 | 90 |
| 841744 | 3" x 9" | VIS-BLK EMPLOYE ONLY | 1 | 6 | 192 |
| 841750 | 3" x 9" | VIS-BLK MEN | 1 | 6 | 192 |
| 841752 | 3" x 9" | VIS-BLK NO SMOKING | 1 | 6 | 192 |
| 841756 | 3" x 9" | VIS-BLK PRIVATE | 1 | 6 | 192 |
| 841758 | 3" x 9" | VIS-BLK RESTROOMS | 1 | 6 | 192 |
| 841762 | 3" x 9" | VIS-BLK WOMEN | 1 | 6 | 192 |
| 842196 | 19" x 15" | PLS-SPC NO PARKING | 1 | 6 | 60 |
| 842268 | 2" | MYL-B/G-PKGD-LTTRS | 1 | 6 | 120 |
| 842270 | 2" | MYL-B/G-PKGD-NMBRS | 1 | 6 | 120 |
| 842272 | 3" | VNL-B/W-PKGD-LTTRS | 1 | 6 | 120 |
| 842274 | 3" | VNL-B/W-PKGD-NMBRS | 1 | 6 | 120 |
| 842276 | 3" | MYL-B/G-PKGD-NMBRS | 1 | 6 | 120 |
| 842282 | 2" | VNL-B/W-PKGD-LTTRS | 1 | 6 | 120 |
| 842284 | 2" | VNL-B/W-PKGD-NMBRS | 1 | 6 | 120 |
| 843444 | 3" | MYL-RFL-B/S-PKGD-LTTR | 1 | 6 | 120 |
| 843445 | 3" | MYL-RFL-B/S-PKGD-# S | 1 | 6 | 120 |
| 844010 | 3" | REFLCTR-RED-SCRW/ADH | 1 | 6 | 120 |
| 844011 | 3" | REFLCTR-BLU-SCRW/ADH | 1 | 6 | 120 |
| 844112 | 4 x 18" | ALU-R/W FIRE XTNGSH | 1 | 6 | 240 |
| 844148 | 6" x 9" | SKO MEN ACCESS ADA | 1 | 3 | 54 |
| 844149 | 6" x 9" | ADA-BRN MEN/WOMEN | 1 | 3 | 54 |
| 844150 | 6" x 9" | ADA-BRN WOMEN PCTGRM | 1 | 3 | 54 |
| 844151 | 6" x 9" | ADA-BLU ACCESSBL PIC | 1 | 3 | 54 |
| 847004 | 2" | VNL-D/C-BLK-PKGD-L/# | 1 | 6 | 120 |
| 847015 | 3" | VNL-D/C-BLK-PKGD-L/# | 1 | 6 | 120 |
| 847026 | 2" | STENCILS-OILBD-LTR/# | 1 | 6 | 108 |
| 847027 | 3" | STENCILS-OILBD-LTR/# | 1 | 6 | 48 |
| 847201 | | REFLECTORS-SMALL CARDED | 1 | 12 | 144 |
| 847212 | 1" | VNL-D/C-BLK-PKGD-L/# | 1 | 6 | 120 |
| 848554 | 2" x 8" | MYL-B/S-EMRGNCY EXIT | 1 | 6 | 330 |
| 848602 | | WET FLR A-FRME SGN-FRNCH | 1 | 3 | 3 |
| 848629 | 1" | MYL-RFL-B/S-PKGD-L/# | 1 | 6 | 120 |
| 848638 | 48" | REFLECTIVE STAFF-ORG | 1 | 24 | 24 |
| 848739 | 5" x 7" | VIS-RED-EXTINCTEUR | 1 | 6 | 150 |
| 848747 | 5" x 7" | VIS-RED-NO SMOKING | 1 | 6 | 150 |
| 848765 | 48" | MKR-2SIDE-DRWWY-RED | 1 | 24 | 1344 |
| 840271 | | 911 ADDRESS KIT -DOUBLE SIDED | 1 | 5 | 20 |

SELF-ADHESIVE LETTERS & NUMBERS REUSABLE STENCILS AUTO-ADHÉSIF LETTRES ET CHIFFRES POCHOIRS RÉUTILISABLES

The Hillman Sign Centre offers the convenience of packaged letters and numbers kits. Choose from several sizes in multiple colour combinations. Attractive black and gold angle-cut aluminium and mylar letters and numbers come in three sizes. Reflective Mylar letters and numbers are flexible, exceptionally durable with high tensile and tear strength, and won't fade in high temperatures.

FEATURING:

- Letters & Numbers Square Cut/Die Cut Kits
- Black on Gold Aluminium
- Die Cut Vinyl and Thin Styles
- Reusable Stencils: Letters/Numbers/Combo



SIGN PROGRAM PROGRAMME DE SIGNALISATION

- SELF-ADHESIVE
- STYRENE
- CORRUGATED
- ALUMINIUM

The Hillman Sign Center's signs are available in a variety of substrates, sizes and colour combinations. With a range of sign titles to choose from, meeting the specific needs of your customers is easy. All signs are made using ultra-violet, fluorescent ink for maximum visibility.

FEATURING:

- Self-Adhesive Mylar & Flexible Vinyl Signs
- Self-Adhesive Molded Plastic Signs
- Styrene Signs: 8" x 12" to 18" x 24"
- Corrugated Signs: 8" x 12" to 20" x 24"
- Aluminium Signs: 10" x 14" to 12" x 18"
- English and French Titles Available



SPECIALTY / NOVELTY SIGNS & ACCESSORIES
AFFICHES ET ACCESSOIRES DE SPÉCIALITÉ

The Hillman Sign Center offers a large variety of specialty and novelty signs for every type of customer. Create your own sign with our large selection of blank Create-A-Sign's in different shapes and colours. Safety tape, reflectors and sign frames are also available in a variety of sizes. LED Open sign, Solar Light bar and Glow-In-The-Dark signs add an extra benefit for your customer.

FEATURING:

- Create-A-Sign Program
- LED Open Sign and LED Solar Light Bar
- Safety Tape, Flagging Tape & Caution Tape
- Sign Frames and Reflectors



KEYS CLÈS



FOR MORE INFORMATION PLEASE CONTACT YOUR SALES REPRESENTATIVE

TRANSponderKEYS™

Automotive Security Keys

DON'T SEND YOUR CUSTOMERS AWAY TO AUTO DEALERS FOR TRANSponder KEYS!

- Made in minutes!
- Easy 2 button Operation.
- No internet required.
- High Retails with High Margins!
- Up to 90% Market Coverage of programmable keys.
- Compatible with any Hillman Key Duplication Platform.
- The Transponder Key Technology Market is growing.
- 9 of the top 10 selling vehicles in Canada are equipped with Transponder based security systems.
- More than 9 million vehicles on Canadian roads are equipped with Transponder Systems.



EZ CLONE PLUS

WHAT IS THE EZ CLONE PLUS SYSTEM?

It's the **critical** 2nd step to finalizing the duplication of automotive keys with Transponder Technology.



YOUR TRUSTED SOURCE FOR KEY DUPLICATION

Three levels of duplication to find the **RIGHT** solution for **YOUR MARKET**.

GOOD

Traditional Technology
Low Cost Operation
Manual Process



BETTER

Improved Technology
Market Leader in Key Duplication



BEST

THE NEXT GENERATION

- New Advanced Machine For Keys
- Laser Identification System
- Lowest Miscut Rate In The Industry
- Touch Screen Technology
- Maximize Store Profits
- 3 Easy Steps in Duplicating a Key
- Built-In Training Video & Application Guides



Precision 4 Laser (P4)

TECHNICAL TECHNIQUE

8.8HV

XYZ

**MECHANICAL REQUIREMENTS
FOR THREADED FASTENERS**

MECHANICAL REQUIREMENTS FOR THREADED FASTENERS FIXATIONS FILETÉES POUR APPLICATIONS MÉCANIQUES

| S.A.E. GRADE (IMPERIAL) | I.S.O. CLASS (METRIC) | S.A.E & PAPCO IDENT. | BOLT SIZE DIAMETER (INCH or MM) | PROOF LOAD (PSI) | TENSILE STRENGTH MIN (PSI) | HARDNESS | |
|--------------------------------------|--|-------------------------|------------------------------------|---------------------|-------------------------------|----------|---------|
| | | | | | | ROCKWELL | VICKERS |
| INCH | | | | | | | |
| 2 | | | 1/4 to 3/4 Over 3/4 to 1-1/2 | 55,000 | 74,000 | B80-B100 | |
| | | | | 33,000 | 60,000 | B70-B100 | |
| MATERIAL - HEAT TREATMENT | <ul style="list-style-type: none"> - Low or medium carbon steel; C: 0.15 to 0.55, P: 0.025 Max., S: 0.025 Max. - For studs only, sulfur content may be 0.33% maximum | | | | | | |

| S.A.E. GRADE (IMPERIAL) | I.S.O. CLASS (METRIC) | S.A.E & PAPCO IDENT. | BOLT SIZE DIAMETER (INCH or MM) | PROOF LOAD (PSI) | TENSILE STRENGTH MIN (PSI) | HARDNESS | |
|--------------------------------------|--|-------------------------|------------------------------------|---------------------|-------------------------------|----------|---------|
| | | | | | | ROCKWELL | VICKERS |
| INCH | | | | | | | |
| 5 | | | 1/4 to 1 Over 1 to 1-1/2 | 85,000 | 120,00 | C25-C34 | |
| | | | | 74,000 | 105,000 | C19-C30 | |
| MATERIAL - HEAT TREATMENT | <ul style="list-style-type: none"> - Medium carbon steel quenched and tempered C: 0.28 to 0.55, P: 0.025 Max., S: 0.025 Max. Tempering Temperature: Min. 425 °C (800 °F) - For studs only, sulfur content may be 0.13% maximum - Medium carbon boron or medium carbon alloy steels, as specified for Grade 8 fasteners, may also be used at the manufacturer's option - There shall be a sufficient hardenability to ensure a microstructure consisting of approximately 90% martensite in the core of threaded sections of the fasteners after hardening and quenching and before tempering. | | | | | | |
| | <ul style="list-style-type: none"> - Carbon steel with additives (e.g. Boron or Cr or Mn) quenched and tempered C: 0.15 to 0.40, P: 0.025 Max., S: 0.025 Max., B: 0.0005 to 0.003 Tempering Temperature: Min. 425 °C (800 °F) - For studs only, sulfur content may be 0.13% maximum. When carbon content in boron steel is less than 0.25% the minimum manganese shall be 0.60% - There shall be a sufficient hardenability to ensure a microstructure consisting of approximately 90% martensite in the core of threaded sections of the fasteners after hardening and quenching and before tempering. | | | | | | |

| S.A.E. GRADE (IMPERIAL) | I.S.O. CLASS (METRIC) | S.A.E & PAPCO IDENT. | BOLT SIZE DIAMETER (INCH or MM) | PROOF LOAD (PSI) | TENSILE STRENGTH MIN (PSI) | HARDNESS | |
|--------------------------------------|---|-------------------------|------------------------------------|---------------------|-------------------------------|----------|---------|
| | | | | | | ROCKWELL | VICKERS |
| INCH | | | | | | | |
| 8 | | | 1/4 to 1-1/2 | 120,000 | 150,000 | C33-C39 | |
| | | | | | | | |
| MATERIAL - HEAT TREATMENT | <ul style="list-style-type: none"> - Medium carbon steel quenched and tempered C: 0.25 to 0.55, P: 0.025 Max., S: 0.025 Max. Tempering Temperature: Min. 425 °C (800 °F) - For studs only, sulfur content may be 0.13% maximum - There shall be a sufficient hardenability to ensure a microstructure consisting of approximately 90% martensite in the core of threaded sections of the fasteners after hardening and quenching and before tempering. | | | | | | |
| | <ul style="list-style-type: none"> - Alloy steel with additives (e.g. Boron or Cr or Mn) quenched and tempered C: 0.20 to 0.55, P: 0.025 Max., S: 0.025 Max. Tempering Temperature: Min. 425 °C (800 °F) - For studs only, sulfur content may be 0.13% maximum - When carbon content in boron steel is less than 0.25% the minimum manganese shall be 0.70% - When boron is added the limits shall be 0.0005% to 0.003% - Alloy steel shall contain at least one of the following elements in the minimum quantity given: Chromium 0.30%, nickel 0.30%, molybdenum 0.20%, vanadium 0.10%, manganese 1.65%. Where elements are specified in combinations of two, three, four, or five and have alloy contents less than those given above, the limit value to be applied for steel class determination is 70% of sum of the individual limit values shown above for two, three, four or five elements concerned. - There shall be a sufficient hardenability to ensure a microstructure consisting of approximately 90% martensite in the core of threaded sections of the fasteners after hardening and quenching and before tempering. | | | | | | |
| | <ul style="list-style-type: none"> - Medium carbon alloy steel quenched and tempered C: 0.28 to 0.55, P: 0.025 Max., S: 0.025 Max. Tempering Temperature: Min. 425 °C (800 °F) - When carbon content in boron steel is less than 0.25% the minimum manganese shall be 0.70% - Alloy steel shall contain at least one of the following elements in the minimum quantity given: Chromium 0.30%, nickel 0.30%, molybdenum 0.20%, vanadium 0.10%, manganese 1.65%. Where elements are specified in combinations of two, three, four, or five and have alloy contents less than those given above, the limit value to be applied for steel class determination is 70% of sum of the individual limit values shown above for two, three, four or five elements concerned. - There shall be a sufficient hardenability to ensure a microstructure consisting of approximately 90% martensite in the core of threaded sections of the fasteners after hardening and quenching and before tempering. | | | | | | |

MECHANICAL REQUIREMENTS FOR THREADED FASTENERS FIXATIONS FILETÉES POUR APPLICATIONS MÉCANIQUES

| S.A.E. GRADE (IMPERIAL) | I.S.O. CLASS (METRIC) | S.A.E & PAPCO IDENT. | BOLT SIZE DIAMETER (INCH or MM) | PROOF LOAD (PSI) | TENSILE STRENGTH MIN (PSI) | HARDNESS | |
|--------------------------------------|---|---|------------------------------------|---------------------|-------------------------------|----------|---------|
| | | | | | | ROCKWELL | VICKERS |
| METRIC | | | | | | | |
| | 8.8 |  | M3 to M39 | 84,000 (580 MPa) | 116,000 (800 MPa) | C22-C34 | 250-335 |
| MATERIAL - HEAT TREATMENT | <ul style="list-style-type: none"> - Carbon steel with additives (e.g. Boron or Mn or Cr) quenched and tempered C: 0.15 to 0.40, P: 0.025 Max., S: 0.025 Max., B: 0.003 Max. Tempering Temperature: Min. 425 °C - In case of plain carbon boron steel with carbon content below 0.25% (cast analysis), the minimum manganese content shall be 0.6% - There shall be a sufficient hardenability to ensure a structure consisting of approximately 90% martensite in the core of threaded sections for fasteners in the "as-hardened" condition before tempering. | | | | | | |
| | <ul style="list-style-type: none"> - Carbon steel quenched and tempered C: 0.25 to 0.55, P: 0.025 Max., S: 0.025 Max., B: 0.003 Max. Tempering Temperature: Min. 425 °C - There shall be a sufficient hardenability to ensure a structure consisting of approximately 90% martensite in the core of threaded sections for fasteners in the "as-hardened" condition before tempering. | | | | | | |
| | <ul style="list-style-type: none"> - Alloy steel quenched and tempered C: 0.20 to 0.55, P: 0.025 Max., S: 0.025 Max., B: 0.003 Max. Tempering Temperature: Min. 425 °C - This alloy steel shall contain at least one of the following elements in the minimum quantity given: Chromium 0.30%, nickel 0.30%, molybdenum 0.20%, vanadium 0.10%. Where elements are specified in combinations of two, three or four and have alloy contents less than those given above, the limit value to be applied for steel class determination is 70% of sum of the individual limit values specified above for two, three or four elements concerned. - There shall be a sufficient hardenability to ensure a structure consisting of approximately 90% martensite in the core of threaded sections for fasteners in the "as-hardened" condition before tempering. | | | | | | |

| S.A.E. GRADE (IMPERIAL) | I.S.O. CLASS (METRIC) | S.A.E & PAPCO IDENT. | BOLT SIZE DIAMETER (INCH or MM) | PROOF LOAD (PSI) | TENSILE STRENGTH MIN (PSI) | HARDNESS | |
|--------------------------------------|---|---|------------------------------------|---------------------|-------------------------------|----------|---------|
| | | | | | | ROCKWELL | VICKERS |
| METRIC | | | | | | | |
| | 9.8 |  | M1.6 to M16 | 95,000 (650 MPa) | 131,000 (900 MPa) | C28-C37 | 290-360 |
| MATERIAL - HEAT TREATMENT | <ul style="list-style-type: none"> - Carbon steel with additives (e.g. Boron or Mn or Cr) quenched and tempered C: 0.15 to 0.40, P: 0.025 Max., S: 0.025 Max., B: 0.003 Max. Tempering Temperature: Min. 425 °C - In case of plain carbon boron steel with carbon content below 0.25% (cast analysis), the minimum manganese content shall be 0.7% - There shall be sufficient hardenability to ensure a structure consisting of approximately 90% martensite in the core of threaded sections for fasteners in the "as-hardened" condition before tempering. | | | | | | |
| | <ul style="list-style-type: none"> - Carbon steel quenched and tempered C: 0.25 to 0.55, P: 0.025 Max., S: 0.025 Max., B: 0.003 Max. Tempering Temperature: Min. 425 °C - There shall be a sufficient hardenability to ensure a structure consisting of approximately 90% martensite in the core of threaded sections for fasteners in the "as-hardened" condition before tempering. | | | | | | |
| | <ul style="list-style-type: none"> - Alloy steel quenched and tempered C: 0.20 to 0.55, P: 0.025 Max., S: 0.025 Max., B: 0.003 Max. Tempering Temperature: Min. 425 °C - This alloy steel shall contain at least one of the following elements in the minimum quantity given: Chromium 0.30%, nickel 0.30%, molybdenum 0.20%, vanadium 0.10%. Where elements are specified in combinations of two, three or four and have alloy contents less than those given above, the limit value to be applied for steel class determination is 70% of sum of the individual limit values specified above for two, three or four elements concerned. - There shall be a sufficient hardenability to ensure a structure consisting of approximately 90% martensite in the core of threaded sections for fasteners in the "as-hardened" condition before tempering. | | | | | | |

MECHANICAL REQUIREMENTS FOR THREADED FASTENERS FIXATIONS FILETÉES POUR APPLICATIONS MÉCANIQUES

| S.A.E. GRADE (IMPERIAL) | I.S.O. CLASS (METR) | S.A.E & PAPCO IDENT. | BOLT SIZE DIAMETER (INCH or MM) | PROOF LOAD (PSI) | TENSILE STRENGTH MIN (PSI) | HARDNESS | |
|--------------------------------------|---|-------------------------|------------------------------------|----------------------|-------------------------------|----------|---------|
| | | | | | | ROCKWELL | VICKERS |
| METRIC | | | | | | | |
| | 10.9 | | M3 to M39 | 120,000 (830 MPa) | 151,000 (1040 MPa) | C32-C39 | 320-380 |
| MATERIAL - HEAT TREATMENT | <ul style="list-style-type: none"> - Carbon steel with additives (e.g. Boron or Mn or Cr) quenched and tempered C: 0.20 to 0.55, P: 0.025 Max., S: 0.025 Max., B: 0.003 Max. Tempering Temperature: Min. 425 °C - In case of plain carbon boron steel with carbon content below 0.25% (cast analysis), the minimum manganese content shall be 0.7% - There shall be sufficient hardenability to ensure a structure consisting of approximately 90% martensite in the core of threaded sections for fasteners in the “as-hardened” condition before tempering. | | | | | | |
| | <ul style="list-style-type: none"> - Carbon steel quenched and tempered C: 0.25 to 0.55, P: 0.025 Max., S: 0.025 Max., B: 0.003 Max. Tempering Temperature: Min. 425 °C - There shall be sufficient hardenability to ensure a structure consisting of approximately 90% martensite in the core of threaded sections for fasteners in the “as-hardened” condition before tempering. | | | | | | |
| | <ul style="list-style-type: none"> - Alloy steel quenched and tempered C: 0.20 to 0.55, P: 0.025 Max., S: 0.025 Max., B: 0.003 Max. Tempering Temperature: Min. 425 °C - This alloy steel shall contain at least one of the following elements in the minimum quantity given: Chromium 0.30%, nickel 0.30%, molybdenum 0.20%, vanadium 0.10%. Where elements are specified in combinations of two, three or four and have alloy contents less than those given above, the limit value to be applied for steel class determination is 70% of sum of the individual limit values specified above for two, three, four elements concerned. - There shall be a sufficient hardenability to ensure a structure consisting of approximately 90% martensite in the core of threaded sections for fasteners in the “as-hardened” condition before tempering. | | | | | | |

IFI – Industrial Fasteners Institute

<http://www.indfast.org>

ASTM - American Society for Testing and Materials

<http://www.astm.org>

SAE - Society of Automotive Engineers

<http://www.sae.org>

AISI - American Iron and Steel Institute

<http://www.steel.org>

ASME - American Society of Mechanical Engineers

<https://www.asme.org>

JIS - Japanese Industrial Standards

<http://www.jisc.go.jp/eng>

ISO - International Organization for Standardization

<http://www.iso.org>

DIN - German Institute for Standardization

<http://www.din.de>



paulin®

Please visit our website to download the most current electronic catalogues or contact your sales representative to obtain printed copies.

www.hpaulin.com



**WOOD SCREWS
VIS À BOIS**

**TAPPING SCREWS
VIS TARAUDEUSES**

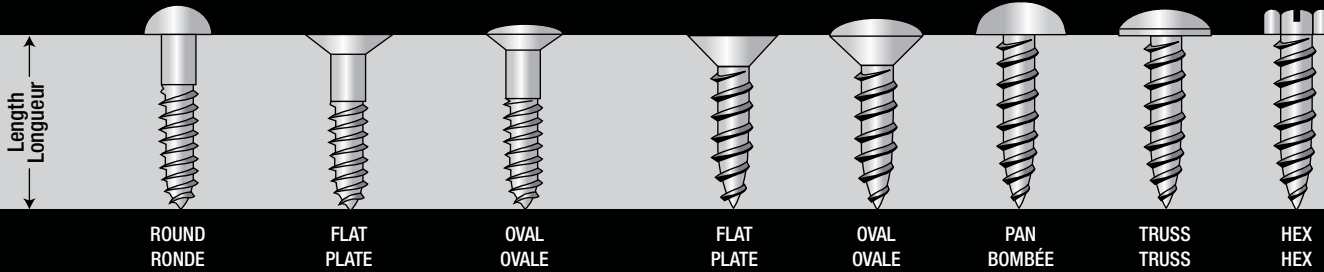

**MACHINE SCREWS
VIS MÉCANIQUES**

**CAP SCREWS and BOLTS
BOULONS et BOULONS DE PRÉCISION**

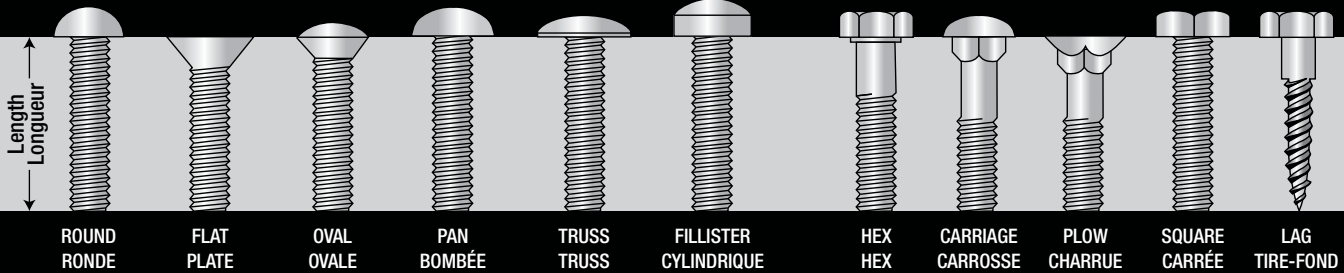

**SET SCREWS and STUDS
VIS DE PRESSION et GOUJONS**

**STANDARD PINS
GOUPILLES REGULIERS**

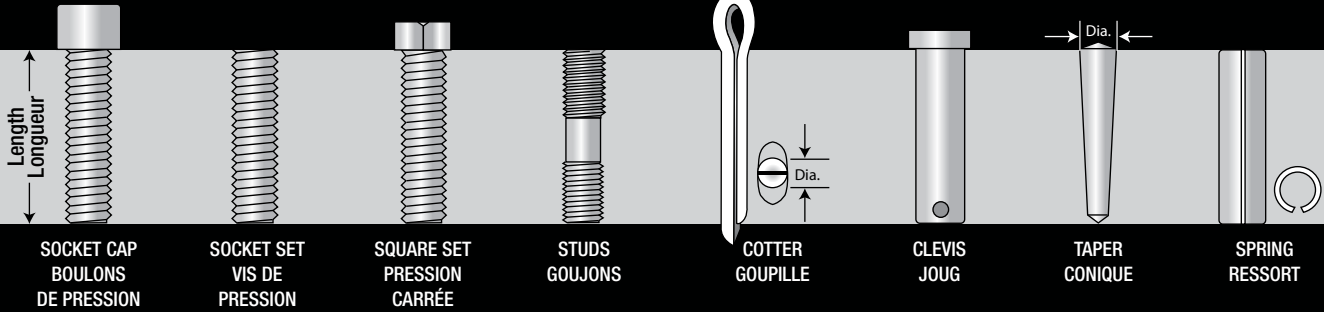

**HEXAGON NUTS
ÉCROUS HEXAGONAUX**

**WASHERS
RONDELLES**

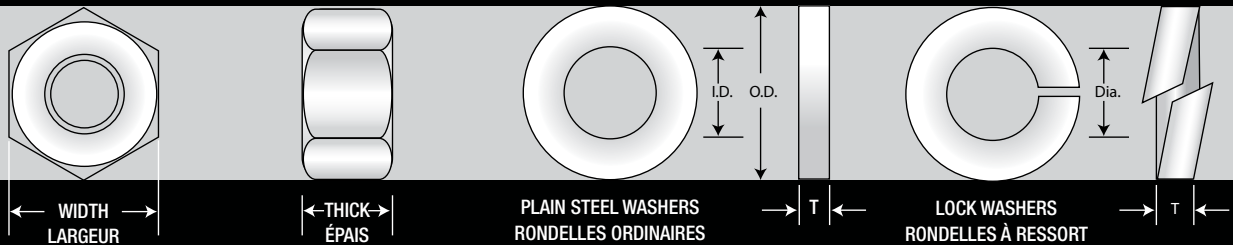

Laval
2591 Debray St.
Laval, QC H7S 2J4
Tel: 1-450-688-4292
Fax: 1-450-688-4750

Edmonton
11714-180th St.
Edmonton, AB T5S 1N7
Tel: 1-780-450-1346
Fax: 1-780-463-3597

Moncton
159 Henri Dunant St.
Moncton, NB E1E 1E4
Tel: 1-506-857-8658
Fax: 1-506-857-9338

Winnipeg
1670-A Inkster Blvd.
Winnipeg, MB R2X 2W8
Tel: 1-204-694-3802
Fax: 1-204-694-3804

Vancouver
3179 Thunderbird Cres.
Burnaby, BC V5A 3G1
Tel: 1-604-421-3096
Fax: 1-604-421-3046