

# QUICKCABLE®

## The World's Most Extensive Line of Battery Boxes

- Marine, auto, commercial, standby power
- In stock, fast delivery



**NEW**  
Battery Box Application  
Guide  
See page 15



**QuickHowTo.com**  
See our videos on the use  
of battery boxes

# The World's Most Extensive Line of Battery Boxes

We make battery boxes for people who use them. Sounds simple. We make them so they're easy to mount, and give you options. We make them so the lids can be secured independently of the mounting system, so you don't have to undo everything just to add some water or check a connection. We make them so they fit right and stand up to temperature extremes – we make battery boxes that work so well you don't have to think about them.

## What do battery boxes do?

- Contain and restrain batteries for safety, and to comply with regulations
- Protect cables and connections
- Contain acid leaks to protect your equipment and the environment
- Protect batteries from external damage



Quick Cable is ISO registered to 9001:2008 standards. We deliver the quality you depend on and we promise.



## The engineered advantages of Quick® Boxes

- More than 30 models to choose from – the widest selection in North America
- Fast reliable delivery – we make them, and we ship them
- Temperature stable in heat and cold
- Chemical and impact resistant
- Multiple mounting options
- Precise battery fit
- Convenient cable routing
- Covers attach independently from mounting system
- Venting to prevent gas build-up



## Where do you find Quick® Boxes?

- |   |   |   |  |  |
|---|---|---|--|--|
| <ul style="list-style-type: none"> <li>Street rods</li> <li>Bass boats</li> <li>Residential solar systems</li> <li>Pop-up tent trailers</li> <li>Tug boats</li> </ul> | <ul style="list-style-type: none"> <li>Modified race cars</li> <li>Semi-tractors</li> <li>Sailboats</li> <li>Fork lifts</li> <li>Motorhomes</li> <li>Off-grid energy systems</li> </ul> | <ul style="list-style-type: none"> <li>Off-road racers</li> <li>Railroad crossings</li> <li>Farm tractors</li> <li>Travel trailers</li> <li>Powered canoes</li> <li>Yachts</li> </ul> | <ul style="list-style-type: none"> <li>Emergency power systems</li> <li>Sprint cars</li> <li>Earth movers</li> <li>Garden tractors</li> <li>Wheel chairs</li> <li>Rod &amp; gun clubs</li> </ul> | <ul style="list-style-type: none"> <li>Charter fishing boats</li> <li>Limousines</li> <li>Desert racers</li> <li>Solar-powered road signs</li> <li>Ambulances</li> </ul> |
|---|---|---|--|--|

## We make our battery boxes in our Wisconsin factory. We can make your custom boxes there, too.

- |   |   |
|---|---|
| <ul style="list-style-type: none"> <li>Engineering services – we can engineer and make custom boxes designed for your unique applications</li> <li>We can modify existing boxes or create entirely new ones for you, depending on your needs</li> </ul> | <ul style="list-style-type: none"> <li>Custom colors, shapes, securing systems, cable ports, sealed or unsealed – whatever you need</li> <li>Ideal for OEMs and custom fabricators</li> </ul> |
|---|---|





# Automotive, Marine, Lawn & Garden & Sportsman's Quick Boxes

These are the boxes most people look for, with the features that all people need. Our legendary QuickBox battery box line covers applications from U1 lawn and garden batteries through Group 24, 27 and 31, covering almost all commonly-used starting and deep cycle batteries for automotive and recreational use.

QuickBox battery boxes are performance engineered with large, wide cable openings, vent holes, our QuickLock cover and holes in the handles to permit mounting with J-hooks, L-bolts, threaded rods and lag screws. We include a heavy-duty tie-down strap and hardware for traditional installations.

Our Sportsman's series offers the same quality in an olive drab color to blend with camo sporting equipment.

## QUICKBOX™ Sportsman's Battery Boxes



### New tougher material

- Cold impact resistant to -30°F (-34°C)
- Heat stable to +200°F (+93°C)
- Meets U.S. Coast Guard Regulations 183.420 and ABYCE-10.7
- Impervious to acid, gasoline, oil and solvents
- Will not rust, UV protected

### Unique features

- QuickLock lid – easy-on easy-off
- Light weight
- Tri-lingual safety warnings in English, French, Spanish
- Olive drab color blends in with camo equipment
- Ideal for all sports – hunting, fishing, boating, RV



# QUICKBOX™ Auto, Light Truck, Marine & RV



## 1 Fits all batteries

- Fits all traditional battery group sizes
- Fits all new orbital or spiral celled, deep cycle, high performance batteries
- New convenient battery box application guide on page 15

## 2 New QuickLock™ cover

- Easy-on and easy-off
- Safe and secure
- Convenient, fast, durable
- QuickLock™ prevents cover loss

## 3 New mounting holes in handle

- Use hold-down holes molded in to reinforced handles
- Use J-hooks, L-hooks, threaded rod or lag bolts
- Remove the lid while keeping the box secure

## 4 New tougher material

- Impact resistant to -30°F (-34°C)
- Heat stable to +200°F (+93°C)
- Meets U.S. Coast Guard Regulations 183.420 & ABYCE-10.7
- Impervious to acid, gasoline, oil and solvents
- Will not rust, UV protected



Group Size	Part No.	Inside Dimensions			Outside Dimensions		
		Length	Width	Height	Length	Width	Height
U1 Black	120170	8"	5-1/4"	7-15/16"	10-3/4"	7-1/2"	8-1/2"
		(20.3 cm)	(13.3 cm)	(20.1 cm)	(27.9 cm)	(19.1 cm)	(21.6 cm)
24 Black	120171*	10-1/2"	7"	9-3/4"	13-1/2"	9-1/4"	10-1/4"
24 White	120179*	(26.7 cm)	(17.8 cm)	(24.8 cm)	(34.3 cm)	(23.5 cm)	(26 cm)
27 Black	120172	12-3/4"	7-1/4"	10"	16-1/8"	9-5/8"	10-7/8"
		(32.4 cm)	(18.4 cm)	(25.4 cm)	(40.9 cm)	(24.4 cm)	(27.6 cm)
Adjustable	120173	14-1/2"	7-1/4"	10-3/8"	17-3/4"	10-1/4"	10-7/8"
24, 27, 31 Black	120173	(36.8 cm)	(18.4 cm)	(26.3 cm)	(45.1 cm)	(26 cm)	(27.6 cm)
24, 27, 31 White	120193	14-1/2"	15-1/2"	10-1/4"	19-7/8"	22-1/2"	12-3/4"
Dual 27, 31	120215	(36.8 cm)	(39.3 cm)	(26.0 cm)	(50.4 cm)	(57.1 cm)	(32.3 cm)
Group 34 Insert	120182	*Use with Group 24 boxes, raises battery 5/8" inside of box.					

Fits All Including Spiral Cell



Battery Group	Box Color	Part No.	Inside Dimensions			Outside Dimensions		
			Length	Width	Height	Length	Width	Height
24	Olive Drab	120211	10-1/2"	7"	9-1/2"	13-1/2"	9-1/4"	10-1/4"
			(26.7 cm)	(17.8 cm)	(24.1 cm)	(34.3 cm)	(23.5 cm)	(26 cm)
Adjustable 24, 27, 31	Olive Drab	120213	14-1/2"	7-1/4"	10-3/8"	17-3/4"	10-1/4"	10-7/8"
			(36.8 cm)	(18.4 cm)	(26.4 cm)	(45.1 cm)	(26 cm)	(27.6 cm)
Heavy duty Replacement Strap	Black	120156	41" (104 cm) UV resistant polypropylene, includes footman loops with four screws.					

Fits All Including Spiral Cell



# Battery Boxes for 6-Volt, GC2 and 4D Batteries

Growing demand for more power and deeper cycles has led to wider use of GC2 and 4D batteries in recreational vehicles, boats, and small alternative energy applications. Our QuickBox line allows you to set up the configuration that works best for your installation, whether it is single batteries, or dual batteries side by side or end to end.

Our single 6-Volt box has the traditional QuickBox engineering with the QuickLock cover. Larger boxes use thumb screws to retain the covers and have foot pads to allow mounting options in low clearance environments like sailboats and campers.

## QUICKBOX™ Single & Dual

- Rugged heavy wall polyethylene construction
- Impervious to acid, gasoline, oil and solvents
- Flame retardant
- Cold temperature impact resistant to -30°F (-34°C)
- Heat stable -30° to +200°F (-34° to +93°C)
- Single box holds ONE 6-Volt battery
- Dual box holds TWO 6-Volt batteries
- Depending on your space requirements, use two boxes side-by-side, end-to-end or use a dual box
- Dual box is molded in black or white



Single 6-Volt



Dual 6-Volt side-by-side, black



Dual 6-Volt side-by-side, white



Dual 6-Volt end-to-end



Construction



Marine



RV



Dual 6-Volt end to end, easy access, and more RV power



Group Size	Typical Batteries in Array	Box Color	Part No.	Inside Dimensions			Outside Dimensions			Mounting Bracket
				Length	Width	Height	Length	Width	Height	
6-Volt/GC2	1	Black	120174	10-3/4" (27.3 cm)	7-1/4" (18.4 cm)	12-1/4" (31.1 cm)	13-1/2" (34.3 cm)	9-1/4" (23.5 cm)	13" (33 cm)	-
<b>Side by Side</b>										
Dual 6-Volt/GC2	2	Black	120175	15" (38.1 cm)	11" (27.9 cm)	13" (33 cm)	20" (50.8 cm)	14-1/2" (36.8 cm)	14-1/2" (36.8 cm)	120331 (2 Included)
Dual 6-Volt/GC2	2	White	120176	15" (38.1 cm)	11" (27.9 cm)	13" (33 cm)	20" (50.8 cm)	14-1/2" (36.8 cm)	14-1/2" (36.8 cm)	120331 (2 Included)
<b>End to End</b>										
Dual 6-Volt Single 4D GC2	2	Black	120177	21-5/8" (55 cm)	9-1/2" (24.1 cm)	11-1/2" (29.2 cm)	26-3/4" (68 cm)	14" (35.6 cm)	12-3/4" (32.4 cm)	120331 (2 Included)

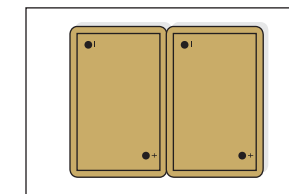

6-Volt dual, side-by-side in box 120175, 120176

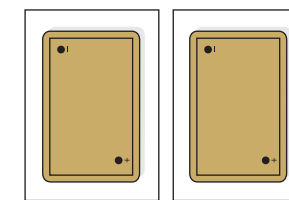

6-Volt single, two boxes (2) 120174

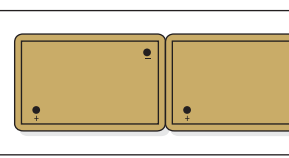

6-Volt dual, end-to-end box 120177

- Contain all components needed for venting Quick Boxes



Part No.	Description
120328	Battery Box Vent Kit
Kit Contains:	
Battery box flange	Wall flange
5' length, 2" hose	Exterior vent cover
2 - hose clamps	





# Commercial Marine, Recreational Vehicles, Construction Machinery, Larger Off-Grid and Backup Power Systems

Big power requirements mean big batteries and big battery boxes. QuickBox commercial boxes are used for 4D, 8D, GC2, L16 and other large arrays.

These boxes traditionally have secured batteries on working boats and heavy construction equipment and now are found in larger residential and small commercial off-grid power systems.

With mounting options to accommodate a variety of installations, venting options and cable routing options including conduit mounting, these battery boxes have been carefully engineered to solve your battery security issues.

## QUICKBOX™ Commercial Boxes

- Rugged, durable, heavy wall construction
- Impervious to acid, gasoline, oil and solvents
- Heat stable to +200°F (-34° to +93°C)
- Cold temperature impact resistant to -30°F (-34°C)
- Flame retardant
- UV stabilized (Rating 6)
- 3-4 way cable channels molded into design
- Rugged durable, heavy wall construction
- Large entry ports for heavy duty cable
- Cover held firmly with convenient thumb screws, no special tools required
- Cover can be locked for protection and tamper resistance
- Vent holes in cover allow gases to escape, preventing dangerous hydrogen build up
- Accommodates a variety of mounting options



Typical Group Size	Typical Batteries in Array	Color	Part No.	Inside Dimensions			Outside Dimensions			Mounting Bracket
				Length	Width	Height	Length	Width	Height	
4D	1	Black	120177	21-5/8" (55 cm)	9-1/2" (24.1 cm)	11-1/2" (29.2 cm)	26-3/4" (68 cm)	14" (35.6 cm)	12-3/4" (32.4 cm)	120331 (2 Included)
8D High	1	Black	120178	21-5/8" (55 cm)	11-3/4" (29.8 cm)	13" (33 cm)	26-3/4" (68 cm)	16-1/2" (41.9 cm)	14" (35.6 cm)	120331 (2 Included)
Dual 8D End-to-End	2	Black	120167	42-1/2" (108 cm)	12" (30.5 cm)	10-3/4" (27.3 cm)	49-1/2" (125.7 cm)	18-1/4" (46.4 cm)	12-1/4" (31.1 cm)	120330 (Optional)
Dual 8D Side-by-Side	2	Black	120168	21-1/2" (54.6 cm)	23-1/2" (59.7 cm)	10-3/4" (27.3 cm)	27" (68.6 cm)	29" (73.7 cm)	12-1/4" (31.1 cm)	120330 (2 Included)
24, 27	6	Black	120163	24" (61 cm)	22-1/2" (57.2 cm)	12-3/4" (32.4 cm)	30-1/2" (77.5 cm)	28-1/2" (72.4 cm)	14" (35.6 cm)	120330 (2 Included)
L16, GC2	4	Black	120166	28-1/2" (72.4 cm)	17" (43.2 cm)	18" (45.7 cm)	36" (91.4 cm)	24" (61 cm)	21" (53.3 cm)	120330 (Optional)

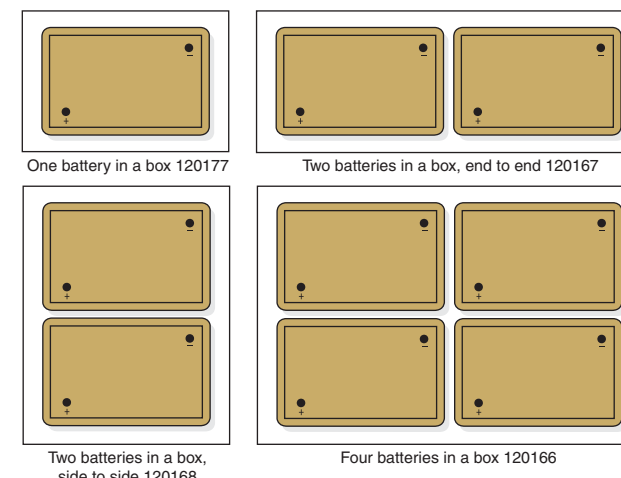

### Battery Box Vent Kit

Contain all components needed for venting Quick Boxes



Part No.	Description
120328	Battery Box Vent Kit
Kit Contains:	
Battery box flange 5' length, 2" hose	Wall flange
2 - hose clamps	Exterior vent cover



# Motorsports & High Security Applications

These boxes were originally designed to meet the stringent requirements of motorsports sanctioning bodies, but they have found applications in other areas. Street rodders like the polished and brushed aluminum look for remote battery installations in custom cars.

But other applications have also emerged. Remote battery installations, like battery backup for railroad crossing equipment, battery-powered solar signage and similar applications use aluminum boxes that can be locked and secured against tampering and theft. So we offer aluminum and painted versions of these boxes to help solve lots of battery installation problems.

## QUICKBOX™

### Sealed Aluminum

These boxes were engineered with racing in mind, featuring an external vent tube to avoid any hydrogen vapor build up that could cause an explosion.

- Meets or exceeds racing specs; NHRA 8:1 and IHRA regulations
- Meets or exceeds boating specs; USCG Code of Federal Regulation 183.420 and ABYC E-10.7
- Optima® and other high performance batteries fit in Group 27-31 box (also Group 24)
- Hardware included

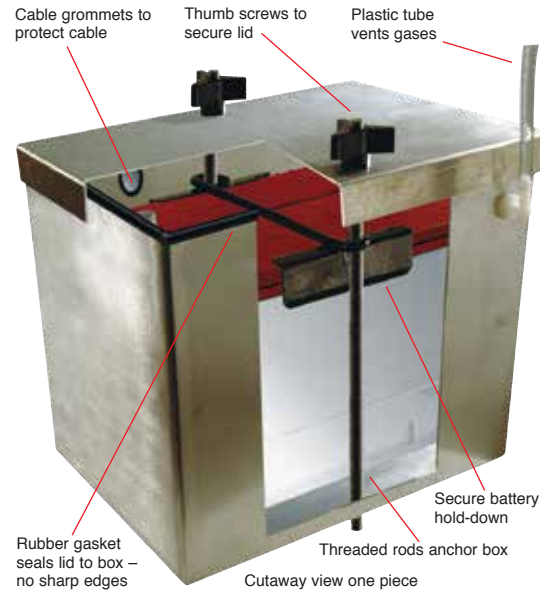

Hardware included with sealed boxes



Group Size	Box Color	Part No.	Inside Dimensions			Outside Dimensions		
			Length	Width	Height	Length	Width	Height
24	Polished Aluminum	120300						
	Brushed Aluminum	120301	11-3/4" (29.9 cm)	8-3/8" (21.3 cm)	10-1/4" (26.1 cm)	12" (20.4 cm)	8-5/8" (21.9 cm)	10-1/2" (26.7 cm)
	Black	120302						
	White	120303						
27-31	Polished Aluminum	120310						
	Brushed Aluminum	120311	14" (35.6 cm)	8-7/8" (22.6 cm)	10-3/4" (27.3 cm)	14-1/4" (36.2 cm)	9-1/8" (23.2 cm)	11" (28 cm)
	Black	120312						
	White	120313						



## QUICKBOX™

### Non-Sealed Aluminum

For applications that do not require an external vented battery. These boxes give you the same crush proof protection without the added cost of external venting.

- Crush-proof protection
- Can be used with a Group 24-27 battery
- Hardware included



Hardware included with non-sealed boxes

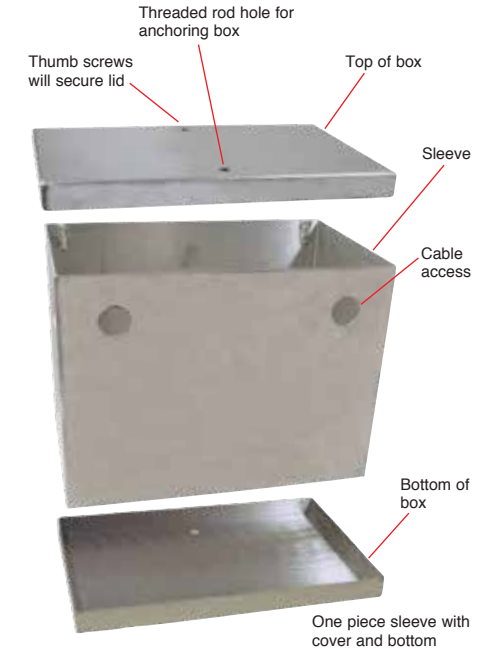

Group Size	Box Color	Part No.	Inside Dimensions			Outside Dimensions		
			Length	Width	Height	Length	Width	Height
24-27	Standard Aluminum	120320						
	Black	120322	14-1/8" (35.9 cm)	8-7/8" (22.6 cm)	10-3/8" (26.4 cm)	14-5/16" (36.4 cm)	9-3/16" (23.3 cm)	10-5/8" (27 cm)
	White	120323						





# Battery Trays for All Applications

The same material and engineering know-how that goes into our commercial battery boxes helps make Quick battery trays the best you can buy.

Using the same forming design as our boxes, our trays are built to hold their shape and resist warping or bending. Trays are designed to contain all the acid from one full battery if it would fail when the tray is loaded to capacity. We have trays designed to fit our battery racks to provide convenient containment in larger installations. We also have trays built to accommodate the most popular combinations of battery arrays.

## Quick® battery trays are engineered to fit Quick® battery racks for a complete system and to work in stand alone applications

- Heavy-gauge material. Compare our trays to any others. We use thicker, stronger material to produce a rugged, durable product
- Trays will accommodate other batteries with similar footprints. For example Group 31 is similar to L16.
- Two types of battery trays – Group 27 and multiple
- Single battery trays can be used to create unique battery layouts (side-by-side, end-to-end, spaced close together or far apart, etc.), and they can be easily moved or removed depending on your maintenance needs
- Multiple battery trays can hold 2, 3, 4 or more batteries, depending on the width and orientation of the batteries
- Trays can act as an acid containment system, either as a primary containment or redundant to a floor-installed containment system
- Trays electrically isolate batteries from battery racks, as required by the National Electrical Code (NEC)
- Trays are made of HDPE which is impervious to acid, gasoline, oil and solvents
- Cold temperature impact resistant to -30°F (-34°C)
- Trays are UV protected, flame retardant, and are heat stable to +170° F (-34° to +90° C)



Reinforced edges



Reinforced corners



Battery tray with three L16/GC2 batteries, 120221



Battery tray with four L16/GC2 batteries, 120220



Battery tray for single battery, available in two sizes



Battery tray with four 8D/4D batteries 120225



## Battery Trays – Poly & Vinyl Coated Steel

- Vinyl coated steel resists corrosion and cold climate cracking, ideal for replacing rusted or damaged OEM style trays
- Drain slots prevent fluid accumulation and aligns with mount holes or brackets
- 11" tray is designed for standard Group 24 size batteries, also fits Groups 1, 2, 17, 22, 23, 42, 54, 55, 56, 72, and 74
- 13" tray is designed for standard Group 27 size batteries, also fits Groups 4, 29, 31, 53, 60 and 77
- Poly tray is lightweight and non-rusting



Battery Tray-Poly



Vinyl-coated Steel

Battery Trays – Poly	
Description	Part No.
Battery Tray, Poly, 11"	302120
Battery Tray, Poly, 13"	302121

Battery Trays – Vinyl Coated Steel	
Description	Part No.
Battery Tray, Steel, 11"	302122
Battery Tray, Steel, 13"	302123

## Multiple Battery Trays

Battery Tray Part No.	Fits Battery Rack	Inside Dimensions			Outside Dimensions			Typical Battery Layout in Tray
		Length	Width	Height	Length	Width	Height	
120220	990180	30-5/8" (77.8 cm)	14" (35.6 cm)	4-3/4" (12 cm)	33" (83.8 cm)	16-3/8" (41.6 cm)	5" (12.7 cm)	 Four L16/GC2
	990181	30-5/8" (77.8 cm)	14" (35.6 cm)	4-3/4" (12 cm)	33" (83.8 cm)	16-3/8" (41.6 cm)	5" (12.7 cm)	
120221	990182	24-5/8" (62.6 cm)	14" (35.6 cm)	4-3/4" (12 cm)	27-1/4" (69.2 cm)	16-3/4" (42.5 cm)	5" (12.7 cm)	 Three L16/GC2
120225	-	46" (117 cm)	21-1/2" (55 cm)	4-3/4" (12 cm)	49" (124.5 cm)	24-1/4" (61.6 cm)	5" (12.7 cm)	 Four 8D/4D

## Single Battery Trays

Part No.	Battery Group	Inside Dimensions			Outside Dimensions			Typical Battery Layout in Tray
		Length	Width	Height	Length	Width	Height	
120189	L16, L16H, U3050, U3050HC	12.75" (32.4 cm)	7.25" (18.4 cm)	10.0" (25.4 cm)	16.2" (40.9 cm)	9.6" (24.4 cm)	10.0" (25.4 cm)	
120187	GC2, GC2H, GC8, U2200, U2300, U2400, U2500, U2500HC	10.5" (26.7 cm)	7" (17.8 cm)	9.5" (24.1 cm)	13.5" (34.3 cm)	9.25" (23.5 cm)	9.5" (24.1 cm)	

# Battery Box Accessories

## Commercial Battery Box Mounting Bracket

- Designed to fit QuickBox commercial boxes by mounting to battery box
- Foot slots allow box to be positioned side to side or front to back depending on installation limitations
- Bracket includes hardware to connect to battery box

Mounting Brackets for Commercial Battery Boxes	
Description	Part No.
(4) 4" Mounting Bracket	120334
41" Mounting Bracket	120333

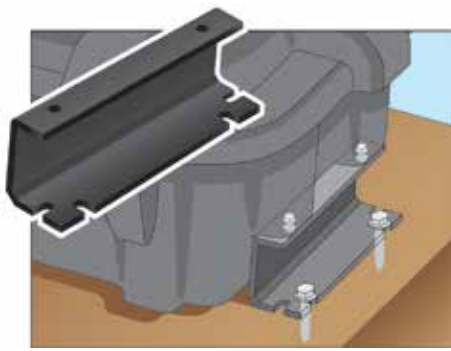

## QuickHold™ Adjustable Battery Hold-Downs

- Adjustable and lockable
- Fiberglass reinforced polypropylene is rust and corrosion-proof
- Non-conductive – eliminates hold-down as source of shorts
- Ideal for all applications – car, truck, bus, off road, marine or recreational installations
- Fits existing hardware or select from hold-down bolts and Group 24 or 27 vinyl coated trays

QuickHold™ Adjustable Battery Hold-Downs		
Description	Min./Max. Extension	Part No.
Offset Hold-Down	4" - 6 1/8"	302101
Offset Hold-Down	5 1/2" - 9"	302102
Flush Hold-Down	8 5/8" - 14 3/4"	302103



Cross Bar Hold-Down 6-7/8"	
Description	Part No.
Adjustable Cross Bar Hold-Down	302201
Center Mount Cross Bar Hold-Down	302202

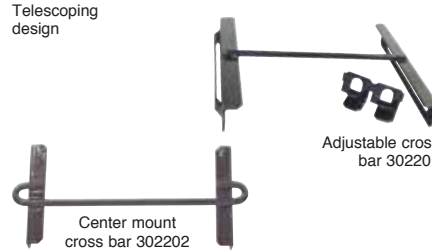

Hold-Down Bolt Sets - 1/4"(6mm) – "L" Style	
Description	Part No.
Hold-Down Bolt Set, 8"	302104
Hold-Down Bolt Set, 10"	302105

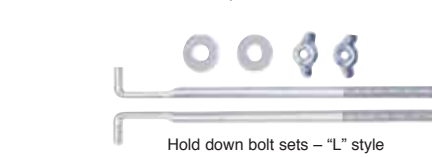

## Hold-Down Bolt Sets – "L" Style & "J" Style

- Long thread accommodates all cross-bar/frame designs including QuickHold products above
- Use with battery trays
- "L" style bend eliminates any need to shift or remove battery
- Sold as pair – hardware included

Hold-Down Bolt Sets - 1/4"(6mm) – "J" Style	
Description	Part No.
Hold-Down Bolt Set, 8"	302106
Hold-Down Bolt Set, 10"	302107
Hold-Down Bolt Set, 12"	302112

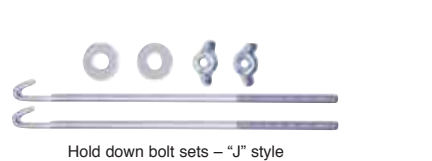

## Ford Base Mount

- Ideal for replacing missing or damaged OEM base mounts
- Vinyl-coated steel resists corrosion, all hardware is included



Base Mounts	
Description	Part No.
Ford Base-Mount Hold-Down	302204

## GM Base Mount & Components for 4D/8D & Dual 6-V Boxes

- Hold down kits for securing 4D/8D and dual 6-volt boxes to work platform
- Zinc plated fasteners

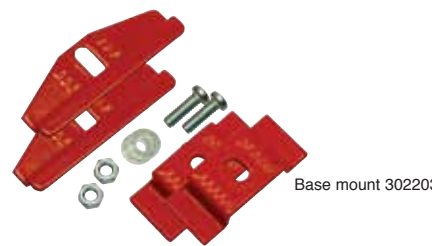

Description	Part No.
Lag Bolt & Washer Kit	420178
Bolt, Nut, Washer Kit	420179
Standard & GM Base Mount	302203



## Heavy Duty Replacement Strap

- Heavy duty strap 41" long, 1.5" wide (104 x 3.8cm), buckle, mounting brackets, and 4 screws
- Made of polypropylene, impervious to battery acid, nylon straps break down in acid
- Strap is UV resistant, won't become brittle in sunlight

Description	Part No.
Heavy Duty Replacement Strap, 41"	120156
Extra Long Strap, 54"	120159



# QUICKBOX™ Application Guide for High Impact Plastic Boxes

Battery Group	Volts	Suggested Battery Boxes	Inside Dimensions			Battery Qty.
			Length	Width	Height	
1	6-V	120173 120213	14-1/2" (36.8 cm)	7-1/4" (18.4 cm)	10-3/8" (26.4 cm)	1
100	12-V	120173 120213	14-1/2" (36.8 cm)	7-1/4" (18.4 cm)	10-3/8" (26.4 cm)	1
101	12-V	120173 120213	14-1/2" (36.8 cm)	7-1/4" (18.4 cm)	10-3/8" (26.4 cm)	1
2	6-V	120173 120213	14-1/2" (36.8 cm)	7-1/4" (18.4 cm)	10-3/8" (26.4 cm)	1
2H	6-V	120171 120211	10-1/2" (26.7 cm)	7" (17.8 cm)	9-3/4" (24.8 cm)	1
2N	6-V	120174	10-3/4" (27.3 cm)	7-1/4" (18.4 cm)	12-1/4" (31.1 cm)	1
3	6-V	120172	12-3/4" (32.4 cm)	7-1/4" (18.4 cm)	10" (25.4 cm)	1
4D	12-V	120177	21-5/8" (55.0 cm)	9-1/2" (24.1 cm)	11-1/2" (29.2 cm)	1
4D LT	12-V	120177	21-5/8" (55.0 cm)	9-1/2" (24.1 cm)	11-1/2" (29.2 cm)	1
8D	12-V	120178	21-5/8" (55.0 cm)	11-3/4" (29.8 cm)	13" (33.0 cm)	1
21	12-V	120171 120211	10-1/2" (26.7 cm)	7" (17.8 cm)	9-3/4" (24.8 cm)	1
21R	12-V	120173 120213	14-1/2" (36.8 cm)	7-1/4" (18.4 cm)	10-3/8" (26.4 cm)	1
22F	12-V	120173 120213	14-1/2" (36.8 cm)	7-1/4" (18.4 cm)	10-3/8" (26.4 cm)	1
22HF	12-V	120173 120213	14-1/2" (36.8 cm)	7-1/4" (18.4 cm)	10-3/8" (26.4 cm)	1
22NF	12-V	120171 120211	10-1/2" (26.7 cm)	7" (17.8 cm)	9-3/4" (24.8 cm)	1
22R	12-V	120173 120213	14-1/2" (36.8 cm)	7-1/4" (18.4 cm)	10-3/8" (26.4 cm)	1
24	12-V	120173 120213	10-1/2" (26.7 cm)	7" (17.8 cm)	9-3/4" (24.8 cm)	1
24F	12-V	120171 120211	10-1/2" (26.7 cm)	7" (17.8 cm)	9-3/4" (24.8 cm)	1
24R	12-V	120171 120211	10-1/2" (26.7 cm)	7" (17.8 cm)	9-3/4" (24.8 cm)	1
25	12-V	120173 120213	14-1/2" (36.8 cm)	7-1/4" (18.4 cm)	10-3/8" (26.4 cm)	1
26	12-V	120171 120211	10-1/2" (26.7 cm)	7" (17.8 cm)	9-3/4" (24.8 cm)	1
26R	12-V	120171 120211	10-1/2" (26.7 cm)	7" (17.8 cm)	9-3/4" (24.8 cm)	1
27	12-V	120172	12-3/4" (32.4 cm)	7-1/4" (18.4 cm)	10" (25.4 cm)	1
27F	12-V	120172	12-3/4" (32.4 cm)	7-1/4" (18.4 cm)	10" (25.4 cm)	1
27R	12-V	120172	12-3/4" (32.4 cm)	7-1/4" (18.4 cm)	10" (25.4 cm)	1
28	12-V	120174	10-3/4" (27.3 cm)	7-1/4" (18.4 cm)	12-1/4" (31.1 cm)	1
29H	12-V	120173 120213	14-1/2" (36.8 cm)	7-1/4" (18.4 cm)	10-1/4" (26.4 cm)	1
29NF	12-V	120173 120213	14-1/2" (36.8 cm)	7-1/4" (18.4 cm)	10-3/8" (26.4 cm)	1
30H	12-V	120173 120213	14-1/2" (36.8 cm)	7-1/4" (18.4 cm)	10-3/8" (26.4 cm)	1
31A	12-V	120173 120213	14-1/2" (36.8 cm)	7-1/4" (18.4 cm)	10-3/8" (26.4 cm)	1
31T	12-V	120173 120213	14-1/2" (36.8 cm)	7-1/4" (18.4 cm)	10-3/8" (26.4 cm)	1
33	12-V	120173 120213	14-1/2" (36.8 cm)	7-1/4" (18.4 cm)	10-3/8" (26.4 cm)	1
34*	12-V	120171 120211	10-1/2" (26.7 cm)	7" (17.8 cm)	9-3/4" (24.8 cm)	1
34R*	12-V	120171 120211	10-1/2" (26.7 cm)	7" (17.8 cm)	9-3/4" (24.8 cm)	1
35	12-V	120173 120213	14-1/2" (36.8 cm)	7-1/4" (18.4 cm)	10-3/8" (26.4 cm)	1
40R	12-V	120173 120213	14-1/2" (36.8 cm)	7-1/4" (18.4 cm)	10-3/8" (26.4 cm)	1
41	12-V	120173 120213	14-1/2" (36.8 cm)	7-1/4" (18.4 cm)	10-3/8" (26.4 cm)	1
42	12-V	120173 120213	14-1/2" (36.8 cm)	7-1/4" (18.4 cm)	10-3/8" (26.4 cm)	1
43	12-V	120173 120213	14-1/2" (36.8 cm)	7-1/4" (18.4 cm)	10-3/8" (26.4 cm)	1
46	12-V	120173 120213	14-1/2" (36.8 cm)	7-1/4" (18.4 cm)	10-3/8" (26.4 cm)	1
47	12-V	120173 120213	14-1/2" (36.8 cm)	7-1/4" (18.4 cm)	10-3/8" (26.4 cm)	1
48	12-V	120173 120213	14-1/2" (36.8 cm)	7-1/4" (18.4 cm)	10-3/8" (26.4 cm)	1
56	12-V	120171 120211	10-1/2" (26.7 cm)	7" (17.8 cm)	9-3/4" (24.8 cm)	1
60	12-V	120173 120213	14-1/2" (36.8 cm)	7-1/4" (18.4 cm)	10-3/8" (26.4 cm)	1
62	12-V	120171 120211	10-1/2" (26.7 cm)	7" (17.8 cm)	9-3/4" (24.8 cm)	1
63	12-V	120171 120211	10-1/2" (26.7 cm)	7" (17.8 cm)	9-3/4" (24.8 cm)	1
64	12-V	120173 120213	14-1/2" (36.8 cm)	7-1/4" (18.4 cm)	10-3/8" (26.4 cm)	1
72	12-V	120173 120213	14-1/2" (36.8 cm)	7-1/4" (18.4 cm)	10-3/8" (26.4 cm)	1
73	12-V	120173 120213	14-1/2" (36.8 cm)	7-1/4" (18.4 cm)	10-3/8" (26.4 cm)	1
75	12-V	120173 120213	14-1/2" (36.8 cm)	7-1/4" (18.4 cm)	10-3/8" (26.4 cm)	1
76	12-V	120173 120213	14-1/2" (36.8 cm)	7-1/4" (18.4 cm)	10-3/8" (26.4 cm)	1
78	12-V	120173 120213	14-1/2" (36.8 cm)	7-1/4" (18.4 cm)	10-3/8" (26.4 cm)	1
79	12-V	120172	12-3/4" (32.4 cm)	7-1/4" (18.4 cm)	10" (25.4 cm)	1
85	12-V	120171 120211	10-1/2" (26.7 cm)	7" (17.8 cm)	9-3/4" (24.8 cm)	1
86	12-V	120171 120211	10-1/2" (26.7 cm)	7" (17.8 cm)	9-3/4" (24.8 cm)	1
90	12-V	120173 120213	14-1/2" (36.8 cm)	7-1/4" (18.4 cm)	10-3/8" (26.4 cm)	1
91	12-V	120173 120213	14-1/2" (36.8 cm)	7-1/4" (18.4 cm)	10-3/8" (26.4 cm)	1
92	12-V	120172	12-3/4" (32.4 cm)	7-1/4" (18.4 cm)	10" (25.4 cm)	1
94R	12-V	120172	12-3/4" (32.4 cm)	7-1/4" (18.4 cm)	10" (25.4 cm)	1
96R	12-V	120172	12-3/4" (32.4 cm)	7-1/4" (18.4 cm)	10" (25.4 cm)	1
97R	12-V	120173 120213	14-1/2" (36.8 cm)	7-1/4" (18.4 cm)	10-3/8" (26.4 cm)	1
98R	12-V	120173 120213	14-1/2" (36.8 cm)	7-1/4" (18.4 cm)	10-3/8" (26.4 cm)	1
GC2	6-V	120174	10-3/4" (27.3 cm)	7-1/4" (18.4 cm)	12-1/4" (31.1 cm)	1
GC2H	6-V	120175	15" (38.1 cm)	11" (27.9 cm)	13" (33 cm)	Side x Side
GC2H	6-V	120176	15" (38.1 cm)	11" (27.9 cm)	13" (33.0 cm)	Side x Side
GC2H	6-V	120177	21-5/8" (55.0 cm)	9-1/2" (24.1 cm)	11-1/2" (29.2 cm)	End x End
GC8	8-V	120174	10-3/4" (27.3 cm)	7-1/4" (18.4 cm)	12-1/4" (31.1 cm)	1
GC8	8-V	120175	15" (38.1 cm)	11" (27.9 cm)	13" (33 cm)	Side x Side
GC8	8-V	120176	15" (38.1 cm)	11" (27.9 cm)	13" (33.0 cm)	Side x Side
GC8	8-V	120177	21-5/8" (55.0 cm)	9-1/2" (24.1 cm)	11-1/2" (29.2 cm)	End x End
U1	12-V	120170	8" (20.3 cm)	5-1/4" (13.3 cm)	7-15/16" (20.1 cm)	1
U1R	12-V	120170	8" (20.3 cm)	5-1/4" (13.3 cm)	7-15/16" (20.1 cm)	1

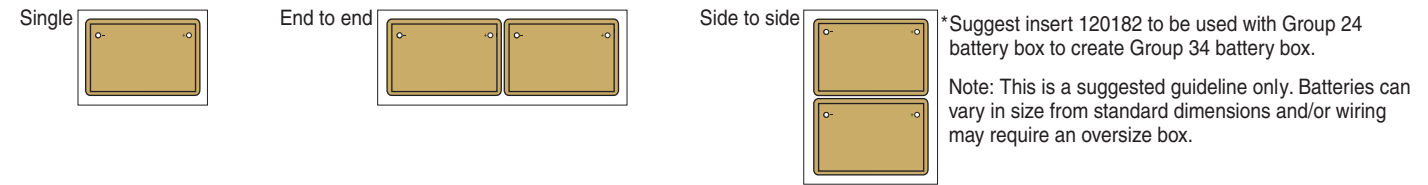

\*Suggest insert 120182 to be used with Group 24 battery box to create Group 34 battery box.  
Note: This is a suggested guideline only. Batteries can vary in size from standard dimensions and/or wiring may require an oversize box.

# QUICKBOX™ Application Guide for Aluminum Boxes

Battery Group	Volts	Suggested Battery Category	Battery Group	Volts	Suggested Battery Category	Battery Group	Volts	Suggested Battery Category	Battery Group	Volts	Suggested Battery Category
1	12-V	B and C	26	12-V	A and C	46	12-V	B and C	92	12-V	B and C
2	12-V	B and C	26R	12-V	A and C	47	12-V	B and C	94R	12-V	B and C
2H	12-V	A and C	27	12-V	B and C	48	12-V	B and C	96R	12-V	B and C
3	12-V	B and C	27F	12-V	B and C	56	12-V	A and C	97R	12-V	B and C
21	12-V	A and C	27R	12-V	B and C	60	12-V	B and C	98R	12-V	B and C
21R	12-V	B and C	29H	12-V	B and C	62	12-V	A and C			
22F	12-V	B and C	29NF	12-V	B and C	63	12-V	A and C			
22HF	12-V	B and C	30H	12-V	B and C	64	12-V	B and C			
22NF	12-V	A and C	31A	12-V	B and C	72	12-V	B and C			
22R	12-V	B and C	31T	12-V	B and C	73	12-V	B and C			
24	12-V	A and C	33	12-V	B and C	75	12-V	B and C			
24F	12-V	A and C	34	12-V	A and C	76	12-V	B and C			
24R	12-V	A and C	34R	12-V	A and C	78	12-V	B and C			
25	12-V	B and C	35	12-V	B and C	79	12-V	B and C			
26	12-V	A and C	40R	12-V	B and C	85	12-V	A and C			
26R	12-V	A and C	41	12-V	B and C	86	12-V	A and C			
24R	12-V	A and C	42	12-V	B and C	90	12-V	B and C			
25	12-V	B and C	43	12-V	B and C	91	12-V	B and C			

Category	Type	Part Numbers
A	Sealed	120300, 120301,
B	Sealed	120302, 120303,
C	Unsealed	120310, 120311,
		120312, 120313,
		120320, 120322,
		120323



# Powerful Online Resources for Product Information, Training, and Custom Ordering

## QuickCable.com

At QuickCable.com you'll find a complete interactive online catalog of all products. It's where you'll find the most up-to-date information on new products and applications, and if you are a registered user, you can order products directly online. There are also extensive resources including instruction manuals, MSDS and RoHS safety sheets as well as catalogs for market-specific applications.



## QuickHowTo.com

This extensive video library offers more than 100 video training programs on product usage, safety, selection, installation, and more. Whether you're looking for information on specific products and applications or managing a training program for your employees, this extensive library is yours to use 24/7 at no charge. It's the added value you get with Quick Cable.



## QuickFigurator.com

Design your own custom cable quickly, online, using our unique quickfigurator.com web tool. You can specify all the components—cable, connectors, heat shrink, etc., save the file, print the drawing, and submit it for quotation. We'll get back to you within 24 hours. Custom cable, painless and fast. Only from Quick Cable.



Distributed by:

